

PVM-9041QM/9044QM

SERVICE MANUAL

AEP Model

PVM-9041QM

Chassis No. SCC-F09B-A

PVM-9044QM

Chassis No. SCC-F09A-A

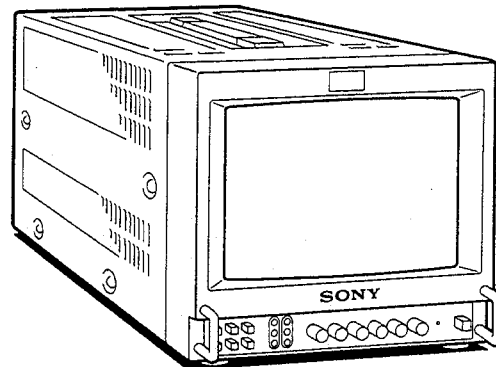

SP 00151

SPECIFICATIONS

Video signal

Color system	PAL, SECAM, NTSC _{3.58} , NTSC _{4.43}
Resolution	PVM-9044QM: 450 TV lines PVM-9041QM: 250 TV lines
Aperture correction	-4.0 dB - +6.0 dB (at 3.0 MHz)
Frequency response	6.0 MHz (-3.0 dB) at all inputs
Synchronization	AFC time constant 1.0 msec.

Picture performance

Normal scan	6% over scan of CRT effective screen area
Underscan	3% underscan of CRT effective screen area
H. linearity	Less than 7.0% (typical)
V. linearity	Less than 7.0% (typical)
Convergence	Central area: 0.43mm (typical) Peripheral area: 0.53mm (typical)
Raster size stability	H: 1.0%, V: 1.5%
High voltage regulation	3.0%
Color temperature	D65

Inputs and Outputs

Inputs	Y/C IN: 4-pin mini DIN connector (See the pin assignment on page 2.) VIDEO IN: BNC connector 1 Vp-p \pm 6dB, sync negative AUDIO IN: phono jack, -5 dBs, less than 47k ohms
--------	---

R/R-Y, G/Y, B/B-Y:	BNC connector R, G, B channels: 0.7 Vp-p, \pm 6 dB Sync on green : 0.3 Vp-p, negative, 75 ohms terminated
R-Y, Y, B-Y channels:	0.7 Vp-p, \pm 6 dB (Standard color bar signal of 100% chrominance)
EXT SYNC IN:	BNC connector Composite sync 4 Vp-p, \pm 6 dB, negative
Loop-through outputs	Y/C OUT: 4-pin mini DIN connector VIDEO OUT: BNC connector, 75 ohms terminated AUDIO OUT: phono jack Output level 0.5 W
Tally/remote input	EXT SYNC OUT: BNC connector, 75 ohms terminated TALLY/REMOTE: 8-pin mini DIN connector (See the pin assignment on page 2.)

General

Power consumption	43 W at AC operation 40 W at DC operation
-------------------	--

- Continued on next page -



TRINITRON® COLOR VIDEO MONITOR
SONY®

PVM-9041QM/9044QM

Power requirements 100 – 240 V AC, 50/60 Hz (for all models)
12 V DC, with the Sony (NP-1A/1B) battery pack (not supplied) or AC-500/500CE AC power adaptor (not supplied)

Operating temperature range
0 – 35 °C

Storage temperature range
–10 – +40 °C

Humidity
0 – 90%

Dimensions Approx. 217 x 217 x 352.5 mm (w/h/d)
(8 5/8 x 8 5/8 x 14 inches)
not incl. projecting parts and controls

Weight Approx. 7.8 kg (17 lb 3 oz)
not incl. battery packs

Accessory supplied AC power cord (1)
Cable with an 8-pin connector

Design and specifications are subject to change without notice.

Pin Assignment

Y/C IN connector (4-pin mini DIN)

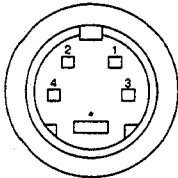

Pin No.	Signal	Description
1	Y-input	1 Vp-p, sync negative, 75 ohms
2	CHROMA sub-carrier-input	300 mVp-p, burst Delay time between Y and C: within 0±100 nsec., 75 ohms
3	GND for Y-input	GND
4	GND for CHROMA-input	GND

TALLY/REMOTE connector (8-pin mini DIN)

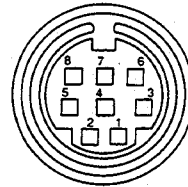

Pin No.	Signal
1	Blue only
2	H/V delay
3	GND
4	INT/EXT SYNC
5	Tally
6	Underscan/normal scan
7	A/B or RGB/Y R-Y B-Y
8	RGB/LINE

For remote control, connect the pin of the desired function to pin 3 (GND).

TABLE OF CONTENTS

<u>Section</u>	<u>Title</u>	<u>Page</u>	<u>Section</u>	<u>Title</u>	<u>Page</u>
1.	GENERAL		4.	SAFETY RELATED ADJUSTMENT	
1-1.	Features	4	4-1.	Safety Related Adjustments	18
1-2.	Location and Function of Parts and Controls	5			
1-3.	Power Sources	8	5.	CIRCUIT ADJUSTMENTS	
			5-1.	D Board Adjustments	20
2.	DISASSEMBLY			B Board Adjustments	23
2-1.	Cabinet Removal	9		S Board Adjustments	28
2-2.	B Board Removal	9			
2-3.	Switching Regulator Removal	10	6.	DIAGRAMS	
2-4.	D Board Removal	10	6-1.	Frame Schematic Diagram	29
2-5.	P Board Removal	11	6-2.	Block Diagram (1)	32
2-6.	Rear Assy Removal	11	6-3.	Block Diagram (2)	35
2-7.	HA and FA Boards Removal	12	6-4.	Circuit Boards Location	40
2-8.	Picture Tube Removal	13	6-5.	Printed Wiring Boards and Schematic Diagrams	40
			6-6.	Semiconductors	76
3.	SET-UP ADJUSTMENTS		7.	EXPLODED VIEWS	
3-1.	Beam Landing	14	7-1.	Chassis	78
3-2.	Convergence	15	7-2.	Picture Tube	79
3-3.	Focus	17			
3-4.	White Balance	17	8.	ELECTRICAL PARTS LIST	80

(CAUTION)

SHORT CIRCUIT THE ANODE OF THE PICTURE TUBE AND THE ANODE CAP TO THE METAL CHASSIS, CRT SHIELD, OR CARBON PAINTED ON THE CRT, AFTER REMOVING THE ANODE.

WARNING!!

AN ISOLATION TRANSFORMER SHOULD BE USED DURING ANY SERVICE TO AVOID POSSIBLE SHOCK HAZARD, BECAUSE OF LIVE CHASSIS. THE CHASSIS OF THIS RECEIVER IS DIRECTLY CONNECTED TO THE AC POWER LINE.

SAFETY-RELATED COMPONENT WARNING !!

COMPONENTS IDENTIFIED BY SHADING AND MARK Δ ON THE SCHEMATIC DIAGRAMS, EXPLODED VIEWS AND IN THE PARTS LIST ARE CRITICAL TO SAFE OPERATION. REPLACE THESE COMPONENTS WITH SONY PARTS WHOSE PART NUMBERS APPEAR AS SHOWN IN THIS MANUAL OR IN SUPPLEMENTS PUBLISHED BY SONY. CIRCUIT ADJUSTMENTS THAT ARE CRITICAL TO SAFE OPERATION ARE IDENTIFIED IN THIS MANUAL. FOLLOW THESE PROCEDURES WHENEVER CRITICAL COMPONENTS ARE REPLACED OR IMPROPER OPERATION IS SUSPECTED.

SECTION 1 GENERAL

1-1. FEATURES

Four color systems available

The monitor can display PAL, SECAM, NTSC_{3.58} and NTSC_{4.43}* signals. The appropriate color system is selected automatically.

* A signal of NTSC_{4.43} is used for playing back NTSC recorded video cassettes with a video tape recorder/player especially designed for use with this system.

Super Fine Pitch Trinitron picture tube

(PVM-9044QM only)

The Super Fine Pitch Trinitron picture tube provides a high resolution picture. Horizontal resolution is more than 450 TV lines at the center of the picture.

Blue only picture

The picture can be displayed in blue and black only. This facilitates hue adjustment and the observation of video noise.

Analog RGB/component input connectors

Analog RGB or component (Y, R-Y and B-Y) signals from video equipment can be input through these connectors.

Y/C input connector

The video signal, split into the chrominance signal (C) and the luminance signal (Y), can be input through this connector, eliminating the interference between the two signals, which tends to occur in a composite video signal, assuring video quality.

Beam current feedback circuit

The built-in beam current feedback circuit assures stable white balance.

Comb filter

When NTSC video signals are received, a comb filter activates to increase the resolution, resulting in fine picture detail without color spill or color noise.

Automatic termination

The Y/C, VIDEO IN and EXT SYNC IN connectors are terminated at 75 ohms inside, when no cable is connected to the loop-through output connectors. When a cable is connected to an output connector, the 75-ohm termination is automatically released.

EIA standard 19-inch rack mounting

By using an MB-507 mounting bracket (not supplied), the monitor can be mounted in an EIA standard 19-inch rack. For details on mounting, see the instruction manual of the MB-507.

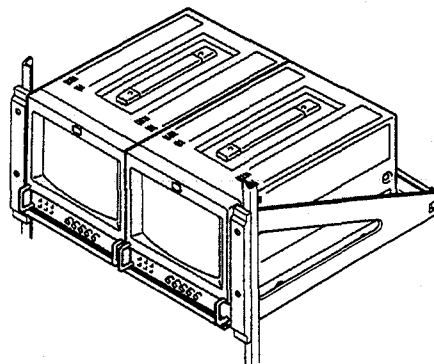

1-2. LOCATION AND FUNCTION OF PARTS AND CONTROLS

Front

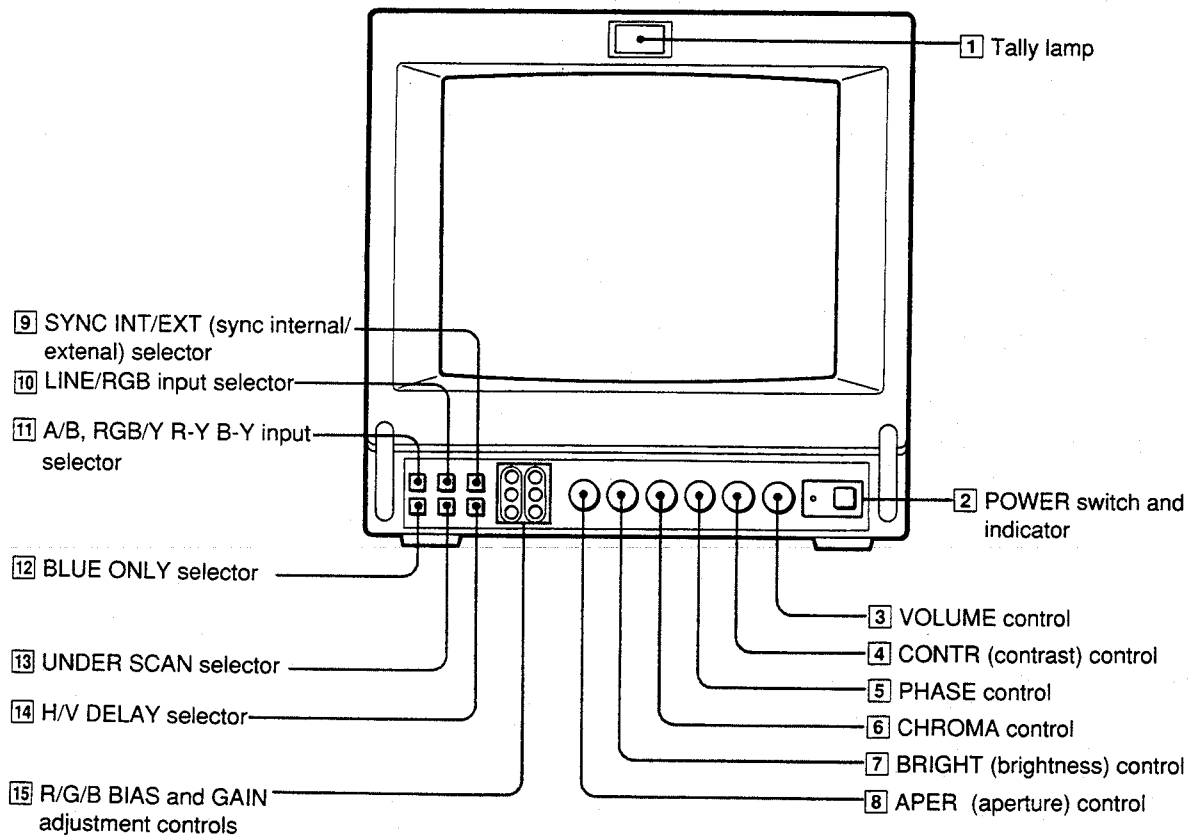
**1 Tally lamp****2 POWER switch and indicator**

Depress to turn the monitor on. The indicator will light up in green.

The POWER indicator also functions as the battery indicator. When the internal battery becomes weak or the power supplied through the DC12V IN jack decreases, the indicator flashes.

3 VOLUME control

Turn this control clockwise or counterclockwise to obtain the desired volume.

4 CONTR (contrast) control

Turn clockwise to make the contrast stronger and counterclockwise to make it weaker.

5 PHASE control

This control is effective only for the NTSC_{3.58} and NTSC_{4.43} color systems. Turn clockwise to make the skin tones greenish and counterclockwise to make them purplish.

Notes

- The PHASE, CHROMA and APER control settings have no effect on an analog RGB signal.
- The PHASE control has no effect on component signals.
- The PHASE control setting is effective only for the NTSC system.

6 CHROMA control

Turn clockwise to make the color intensity stronger and counterclockwise to make it weaker.

7 BRIGHT (brightness) control

Turn clockwise for more brightness and counterclockwise for less.

8 APER (aperture) control

Turn clockwise for more sharpness and counterclockwise for less.

9 SYNC INT/EXT (sync internal/external) selector

Keep this button released (INT) to operate the monitor on the sync signal from the displayed composite video signal.

Depress this button (EXT) to operate the monitor on an external sync signal fed through the EXT SYNC connector on the rear panel.

10 LINE/RGB input selector

Select the program to be monitored. Keep this button released (LINE) for a signal fed through the LINE A or LINE B connectors. Depress this button (RGB) for a signal fed through the RGB connectors.

11 A/B, RGB/Y R-Y B-Y input selector

When the LINE/RGB input selector is set to LINE, keep this button released (A) for a signal fed through the LINE A connectors. Depress this button (B) for a signal fed through the LINE B connectors.

When the LINE/RGB input selector is set to RGB, select the RGB signal or the component signal which is fed through the RGB input connectors. Keep this button released (RGB) for the RGB signal. Depress this button (Y R-Y B-Y) for the component signal.

12 BLUE ONLY selector

Depress this button to turn off the red and green signals. A blue signal is displayed as an apparent monochrome picture on the screen. This facilitates "chroma" and "phase" control adjustments and the observation of video noise.

13 UNDER SCAN selector

Depress this button for underscanning. The display size is reduced by approximately 3% so that four corners of the raster are visible.

14 H/V DELAY selector

Depress this button to observe the horizontal and vertical sync signals at the same time. The horizontal sync signal is displayed in the left quarter of the screen; the vertical sync signal is displayed near the center of the screen.

15 R/G/B BIAS and GAIN adjustment controls

Used for white balance fine adjustment. BIAS and GAIN controls are provided for the R (red), G (green) and B (blue) screens.

BIAS: Adjust the white balance and brightness of the screen at the lowlight.

GAIN: Adjust the white balance and brightness of the screen at the highlight.

Rear

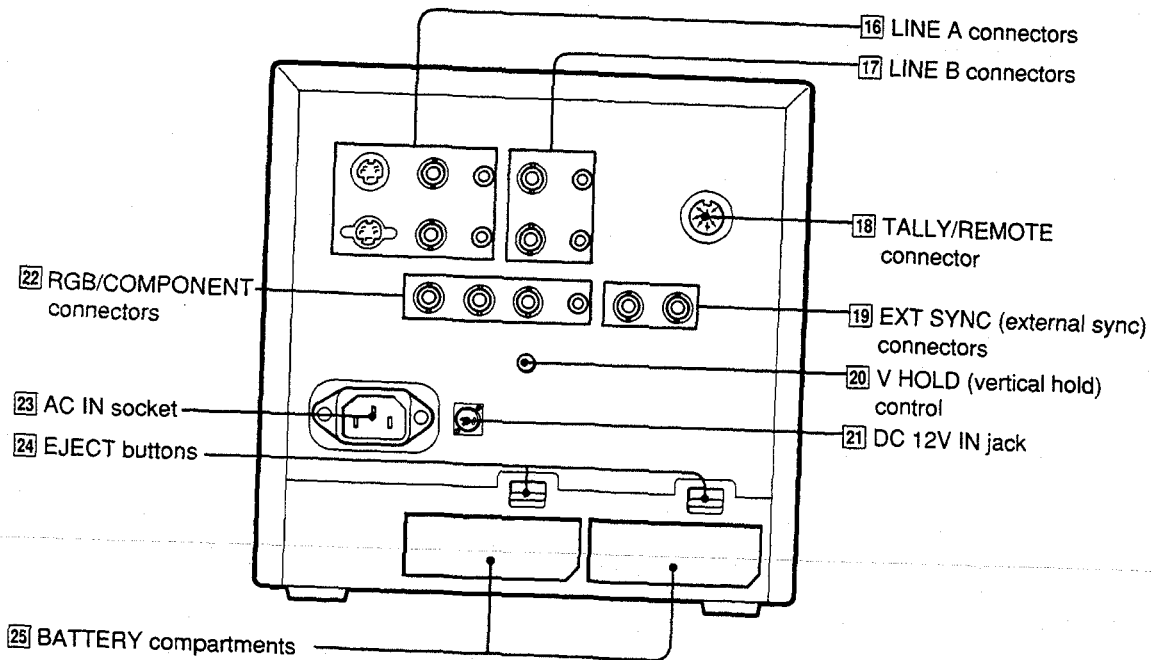

16 LINE A connectors

To monitor the signal fed through these connectors, keep the LINE/RGB selector and the A/B, RGB/Y R-Y B-Y selector on the front panel released (LINE and A).

Note

The Y/C IN connector has a priority over the VIDEO IN connector.

When a plug is connected to the Y/C IN connector, the VIDEO IN connector is automatically disconnected.

17 LINE B connectors

To monitor the signal fed through these connectors, keep the LINE/RGB selector released (LINE) and depress the A/B, RGB/Y R-Y B-Y selector (B) on the front panel.

VIDEO IN (BNC): Connect to the video output of a video camera, VCR or other video equipment.

VIDEO OUT (BNC): Loop-through output of the VIDEO IN connector. Connect to the video input of a VCR or another monitor.

AUDIO IN (phono jack): Connect to the audio output of a VCR or a microphone (through a suitable microphone amplifier).

AUDIO OUT (phono jack): Loop-through output of the AUDIO IN connector. Connect to the audio input of a VCR or another monitor.

18 TALLY/REMOTE connector (8-pin mini DIN)

Connect to the tally output of a control console, special-effect generator, etc. The tally lamp on the front panel will be turned on and off by the connected equipment. This connector can be used for connecting a remote controller. For the pin assignment of this connector, see "Specifications" on page 2.

19 EXT SYNC (external sync) connectors

IN (BNC): When this monitor operates on an external sync signal, connect the reference signal from a sync generator to this connector. In this case, depress the SYNC INT/EXT selector (EXT) on the front panel.

OUT (BNC): Loop-through output of the EXT SYNC IN connector. Connect to the external sync input of video equipment to be synchronized with this monitor.

20 V HOLD (vertical hold) control

Turn to stabilize the picture if it rolls vertically.

21 DC 12V IN jack (XLR, 4 pin)

Connect the Sony AC-500/500CE AC power adaptor (not supplied).

22 RGB/component input connectors

R/R-Y, G/Y, B/B-Y (BNC), AUDIO (phono):

To monitor a signal fed through these connectors, depress the LINE/RGB selector on the front panel (RGB). When the SYNC INT/EXT selector on the front panel is released (INT), the monitor operates on the sync signal from the G/Y channel.

To monitor the analog RGB signal

Connect to the analog RGB signal outputs of a video camera having no sync signal. Keep the A/B, RGB/Y R-Y B-Y selector on the front panel released (RGB).

To monitor the component signal

Connect to the R-Y/Y/B-Y component signal outputs of a Sony BetaCam video camera. Depress the A/B, RGB/Y R-Y B-Y selector on the front panel (Y R-Y B-Y).

23 AC IN socket

Connect the supplied AC power cord to this socket and to a wall outlet.

24 EJECT buttons

Press the EJECT button upwards to remove the battery pack.

25 BATTERY compartments

Insert the NP-1A/1B battery pack (not supplied).

1-3. POWER SOURCES

House Current

Connect the supplied AC power cord to the AC IN socket and to a wall outlet.

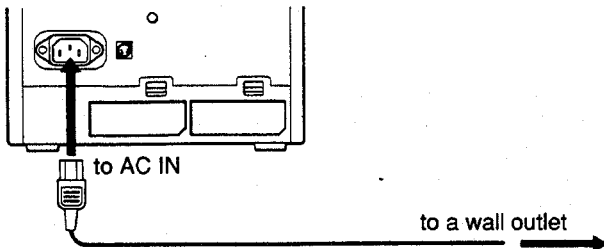

When the AC power cord is plugged into the AC IN socket, the battery pack (if installed) or the AC power adaptor (if connected) is automatically disconnected.

Rechargeable Battery

The monitor can operate with one or two battery packs. For extended use, two battery packs are recommended.

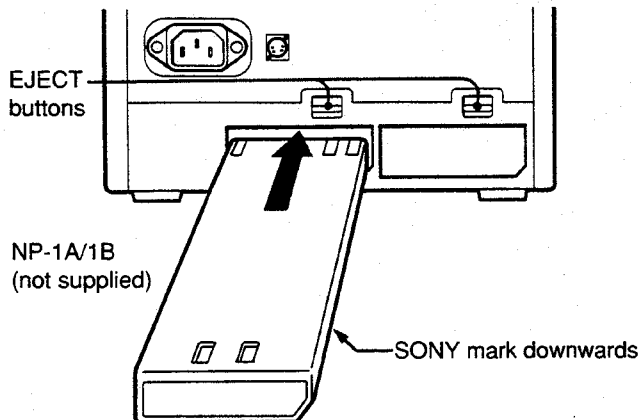

To remove the battery pack, press the EJECT button upwards.

For charging, use the BC-1WA battery charger (not supplied) for the NP-1A or the BC-1WB for the NP-1B.

Note

Make sure that the AC power cord and the AC power adaptor are disconnected from the monitor. Otherwise, the monitor cannot operate on the battery pack(s).

SECTION 2 DISASSEMBLY

2-1. CABINET REMOVAL

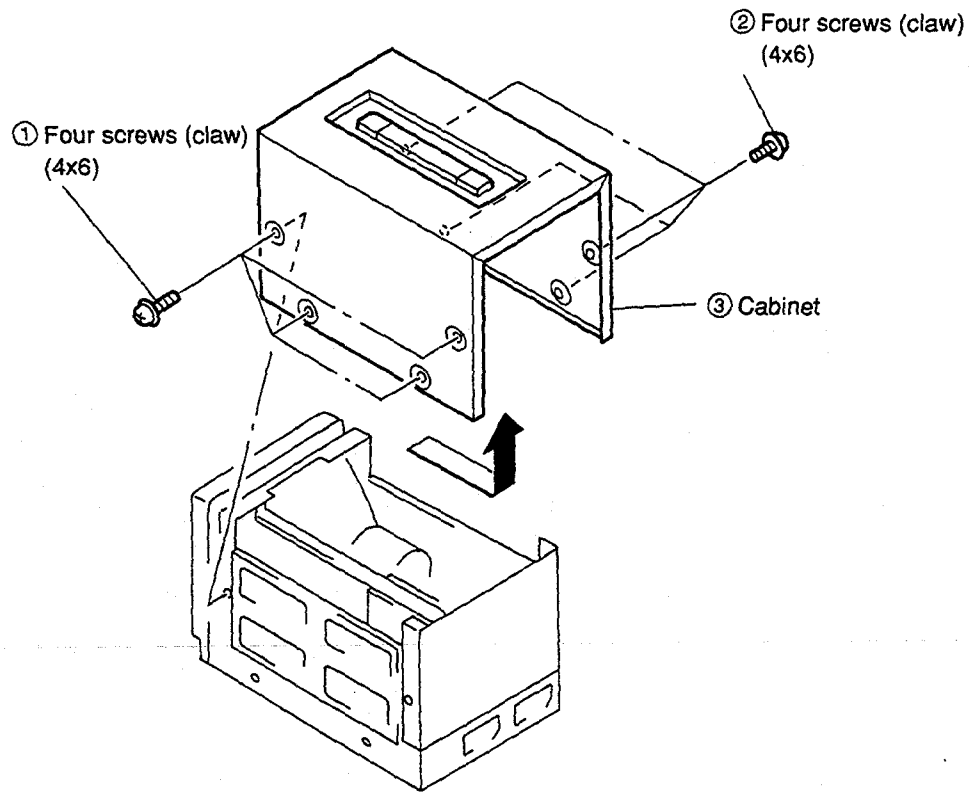

2-2. B BOARD REMOVAL

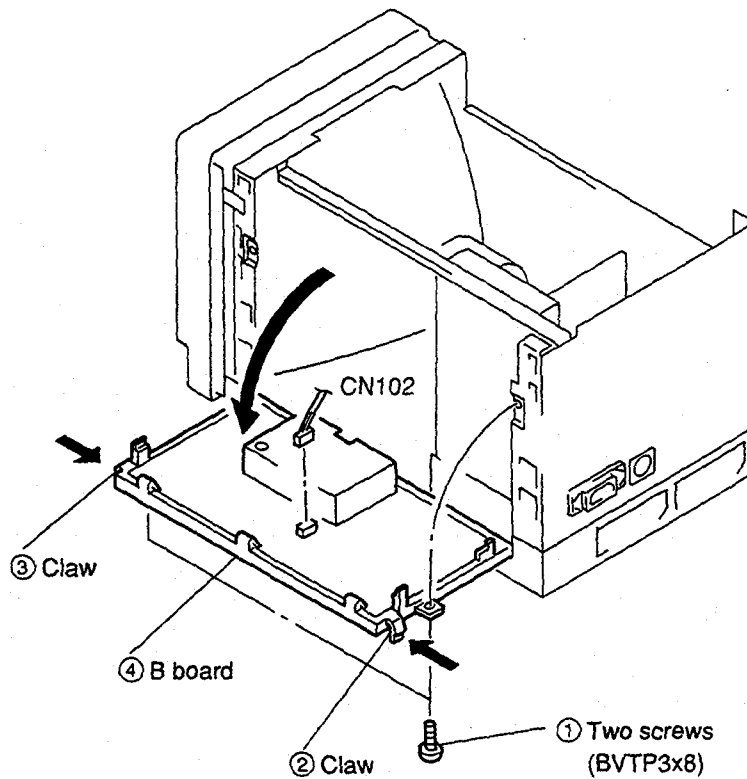

2-3. SWITCHING REGULATOR REMOVAL

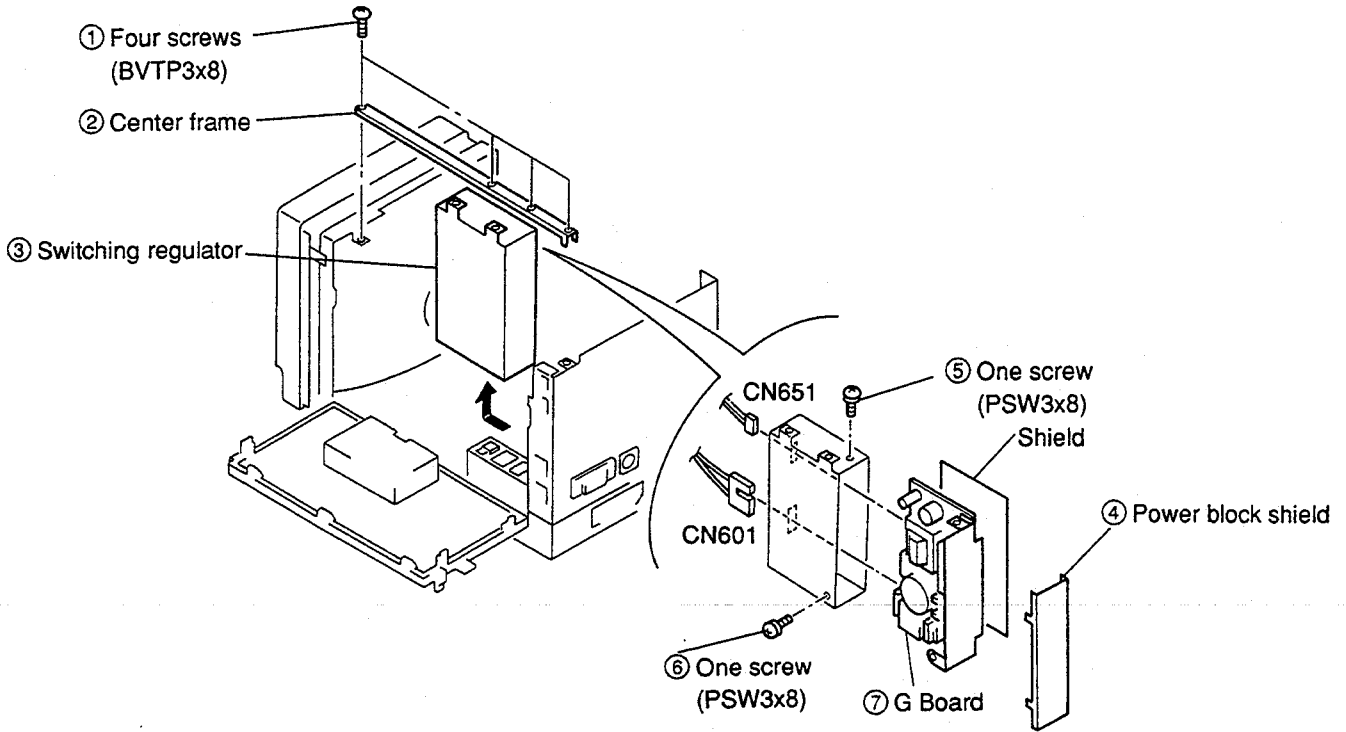

2-4. D BOARD REMOVAL

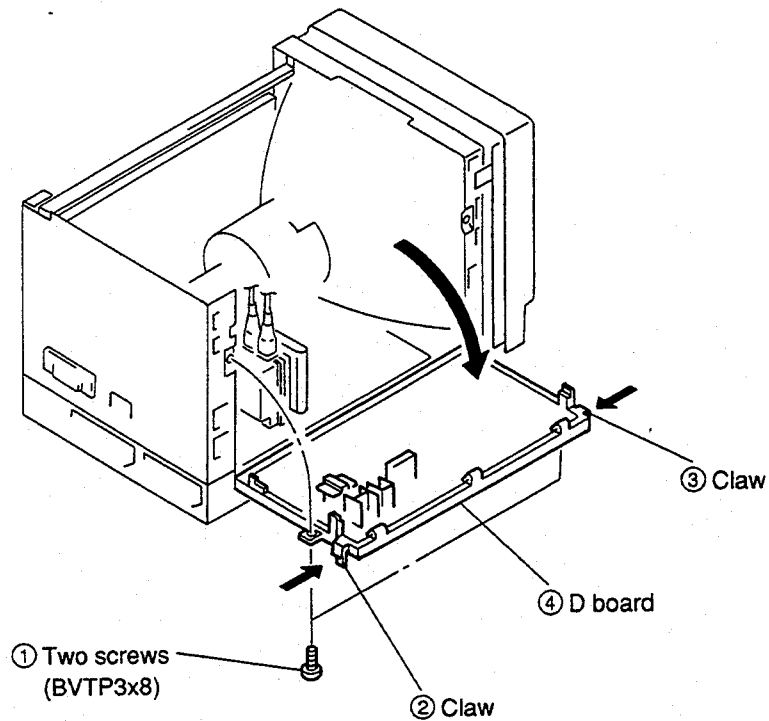

2-5. P BOARD REMOVAL

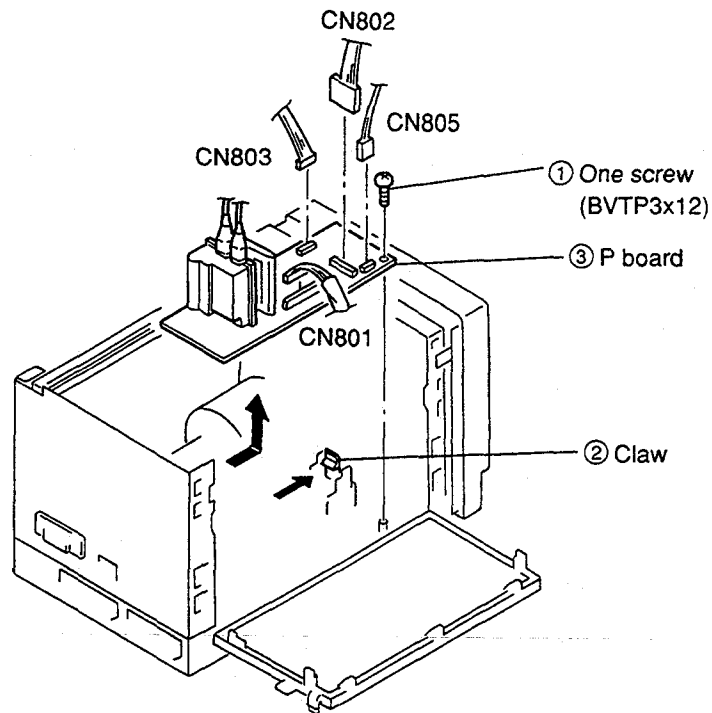

2-6. REAR ASSY REMOVAL

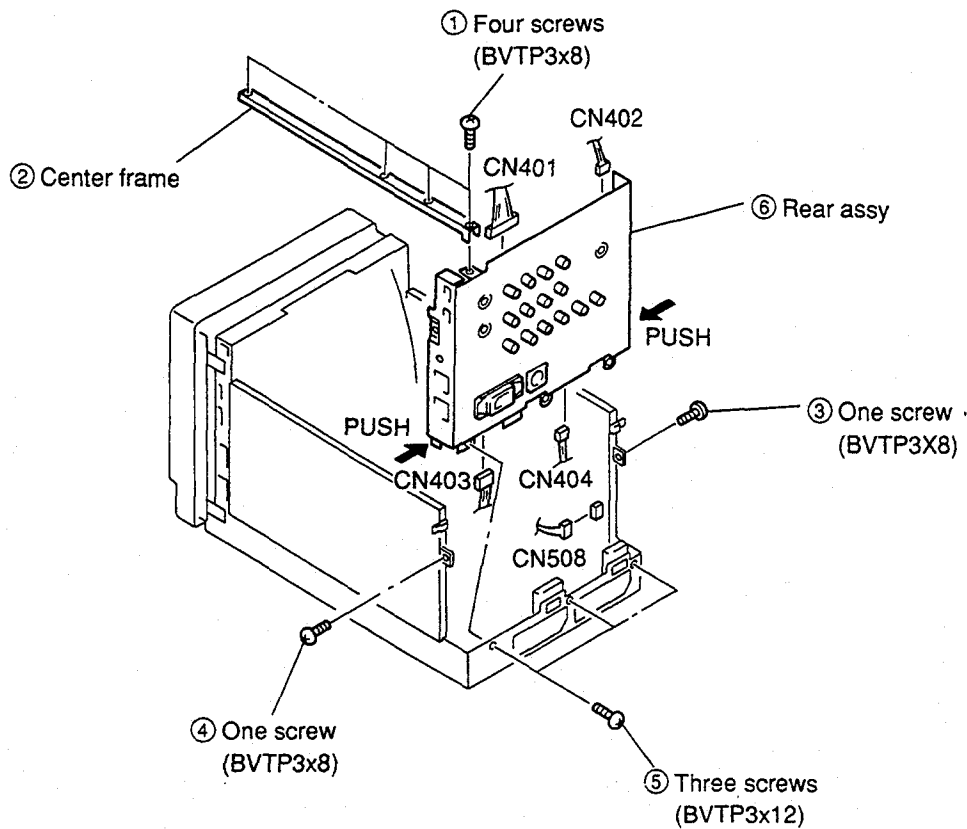

2-7. HA AND FA BOARDS REMOVAL

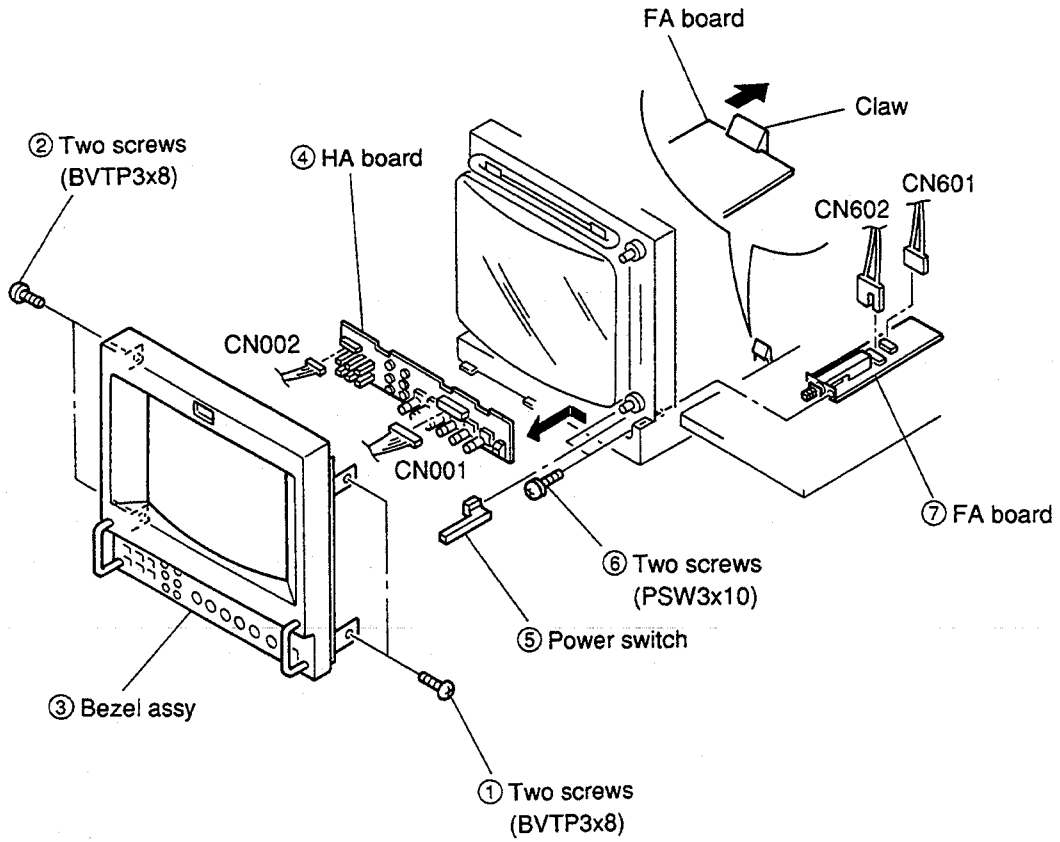

2-8. PICTURE TUBE REMOVAL

Note : Caution for ANODE CAP installation.

When you replace PICTURE TUBE or FBT, remove RTV on ANODE CAP so that PICTURE TUBE and FBT can be separated. Please adhere picture tube and anode cap in accordance with the following procedure.

ADHERING PROCEDURE OF ANODE CAP.

1. Clean PICTURE TUBE ANODE CAP with ethnaol to remove original RTV.
2. Dry clean face with air.

3. Use KE-490RTV (RTV silicone adhesive, SHIN-ETSU CHEMICAL).

Part. No.	Description
7-322-065-19	Silicone (RTV) KE-490W

4. Install ANODE CAP.
5. Adequately apply RTV to the entire picture tube anode area, piace the anode cap onto the picture tube and push it down security so that no air pockets remain beneath the cap.
6. Dry more than 12 hours at room temperature.

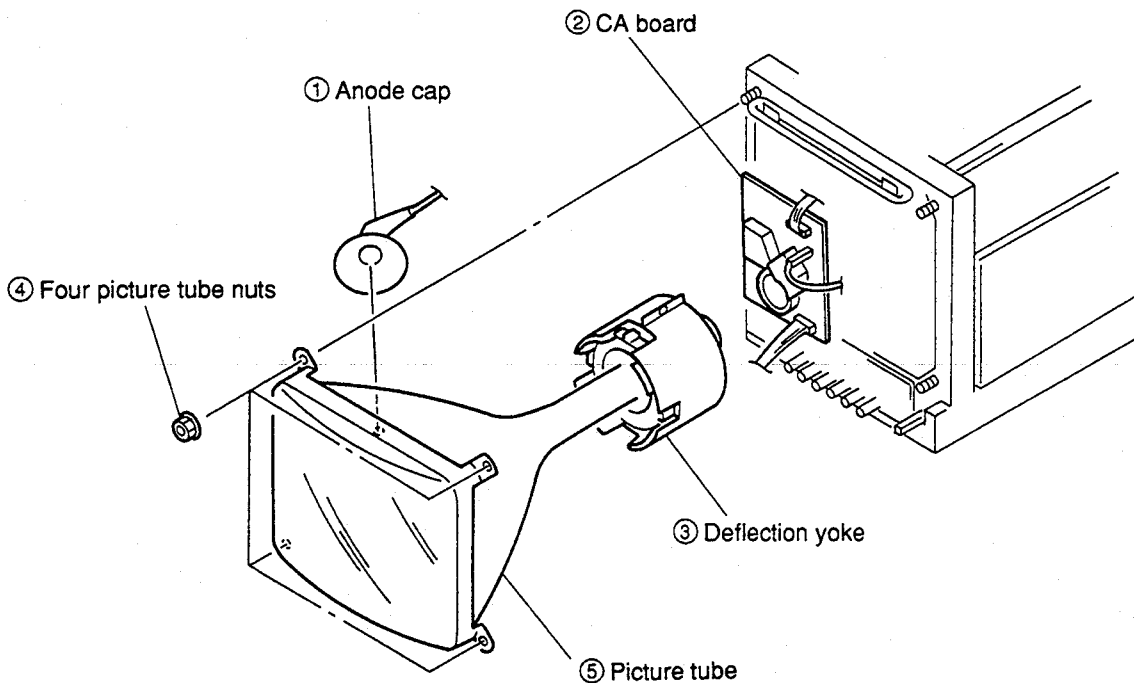

• **REMOVAL OF ANODE-CAP**
• **REMOVING PROCEDURES**

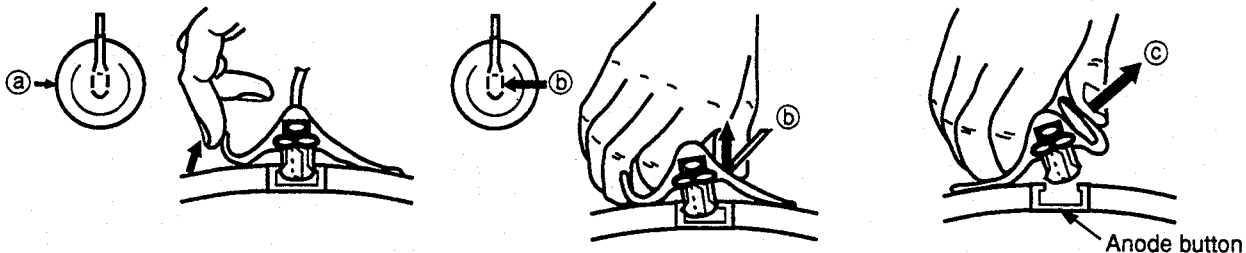

- ① Turn up one side of the rubber cap in the direction indicated by the arrow ①a.
- ② Using a thumb pull up the rubber cap firmly in the direction indicated by the arrow ②b.
- ③ When one side of the rubber cap is separated from the anode button, the anode-cap can be removed by turning up the rubber cap and pulling up it in the direction of the arrow ③c.

• **HOW TO HANDLE AN ANODE-CAP**

- ① Don't hurt the surface of anode-caps with sharp shaped material!
- ② Don't press the rubber hardly not to hurt inside of anode-caps!
A metal fitting called as shatter-hook terminal is built in the rubber.
- ③ Don't turn the foot of rubber over hardly!

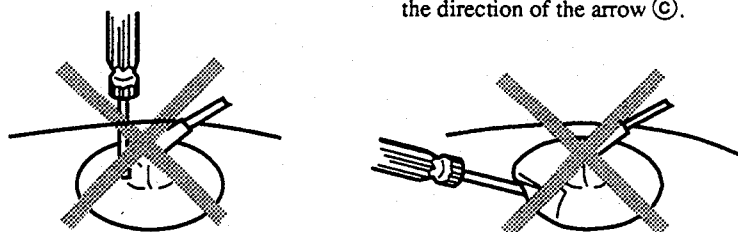

SECTION 3 SET-UP ADJUSTMENTS

- The following adjustments should be made when a complete realignment is required or a new picture tube is installed.
- These adjustments should be performed with rated power supply voltage unless otherwise noted.

The control and switch below should be set as follows unless otherwise noted:

CONTRAST control 80%
 BRIGHTNESS control 50%

Perform the adjustments in order as follows:

- 3-1. Beam Landing
- 3-2. Convergence
- 3-3. Focus
- 3-4. White Balance

Note: Test equipment Required.

1. Color Bar/Pattern Generator
2. Degausser
3. Color Analyzer (Minolta)
4. Luminance Level Meter

3-1. BEAM LANDING

Precaution

1. Set the side of the unit with the PICTURE TUBE so that it faces east or west in order to reduce the influence of external magnetic force.
2. Turn the power switch for the unit ON and erase the magnetic force using a degausser.

(1) Beam Landing

1. Receive an entirely white signal with the pattern generator.
 CONTRAST MAX.
 BRIGHTNESS set easy to observe
2. Adjust the white balance, G2 voltage and convergence roughly.
3. Loosen the deflection yoke mounting screw, and set the purity control to the center as shown in Fig.3-1.
4. Switch over the pattern generator to green.
5. Move the deflection yoke backward, and adjust with the purity control so that green is in the center and blue and red are at the sides, evenly. (Fig.3-2)
6. Move the deflection yoke forward, and adjust so that the entire screen becomes green. Repeat 5 to 7 as to red and blue.
7. When landing at the corners is not right, correct by using the magnet. (Fig.3-3)
8. When the position of the deflection yoke is determined, tighten it with a deflection yoke mounting screw.

CAUTION: When correction magnet is used, be sure to degauss the unit.

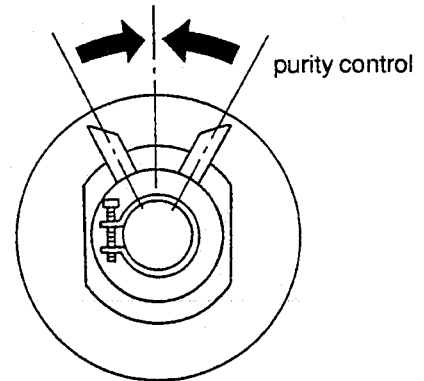

Fig.3-1

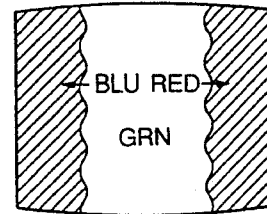

Fig.3-2

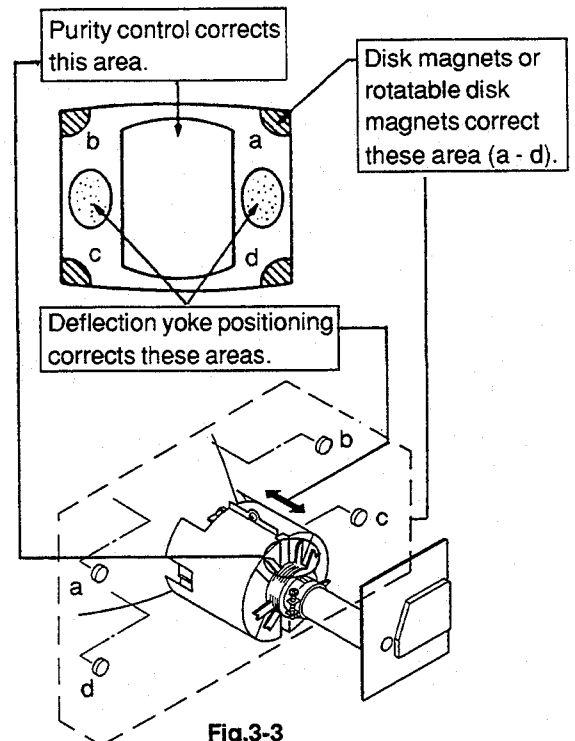
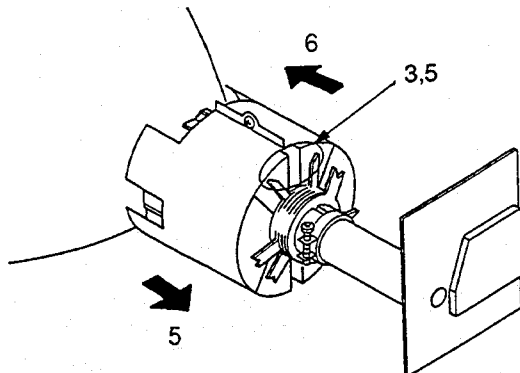

Fig.3-3

3-2. CONVERGENCE

(1) Horizontal and vertical Static Convergence Adjustment on the Center of Screen.

- Before starting, perform V. SIZE, V. CENT, H.SIZE, H.CENT and Screen Distortion Adjustment rightly.

(Static Convergence Adjustment)

1. Receive a dot signal, setting BRIGHTNESS minimum and set CONTRAST to normal.
2. Adjust H.STAT VR to coincide red, green and blue dots on the center of screen. (Horizontal movement)
3. Adjust V.STAT magnet to coincide red, green and blue dots on the center of screen. (Vertical movement)

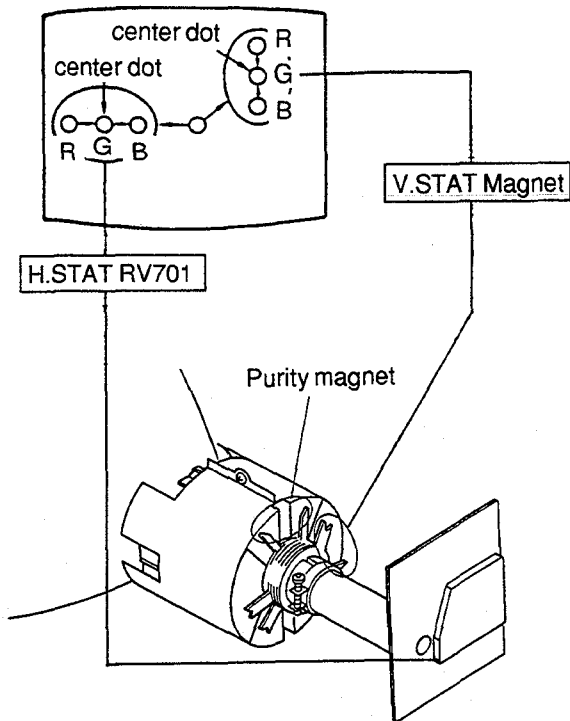

* If the red, green and blue dots do not coincide on the center of screen with H.STAT VR, perform adjustment using V.STAT at the same time while tracking. (Tilt the V.STAT magnet and adjust static convergence to open or close the V.STAT magnet.)

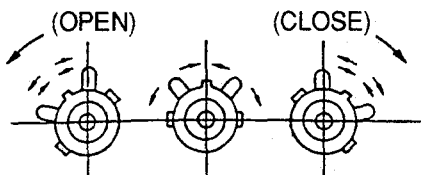

4. When the V.STAT magnet is moved in the direction of arrow A and b, red, green and blue dots move as shown below.

① When moving the V.STAT Magnet open or close.

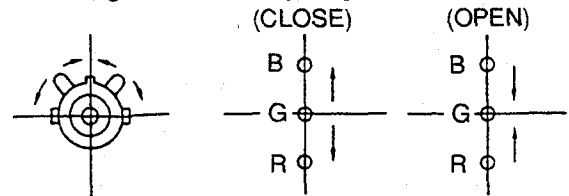

② When moving the V.STAT magnet counterclockwise.

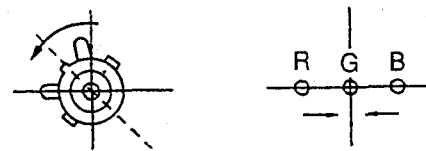

③ When moving the V.STAT magnet clockwise.

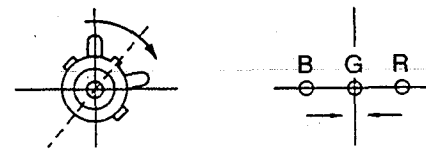

④ When tilt the V.STAT magnet and open or close.

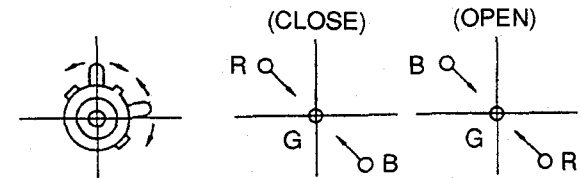

* If the red and green dots do not coincide with blue dot, adjustment with BMC (6-poles) magnet.

5. HMC and VMC correction for BMC (6-Poles) magnet.

① HMC (Horizontal Misconvergence) correction and motion of the Electron Beam with the BMC (6-poles) magnet.

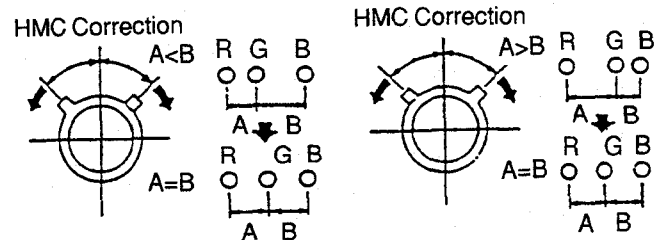

- ② VMC (Vertical Misconvergence) correction and motion of the Electron Beam with the BMC (6-poles) magnet.

VMC Correction (A)

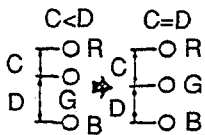
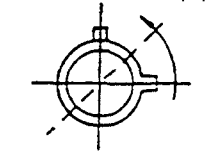

VMC Correction (B)

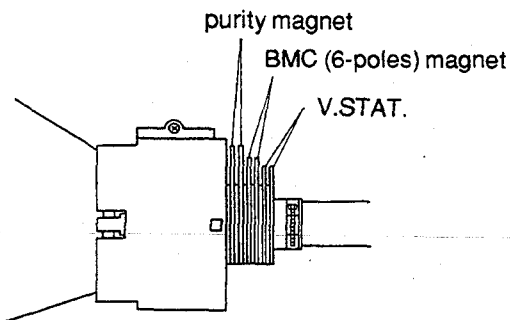
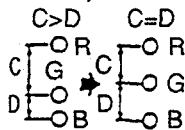
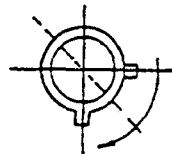

(2) Horizontal and Vertical Dynamic Convergence Adjustment at the Environs of the Screen (Dynamic Convergence Adjustment)

1. When there is misconvergence at the sides of screen, adjust for best convergence as follows by moving the deflection yoke.
2. Loosen deflection yoke screw. Remove deflection yoke spacers. Move the deflection yoke for best convergence. Tighten the deflection yoke screw. Install three deflection yoke spacers.

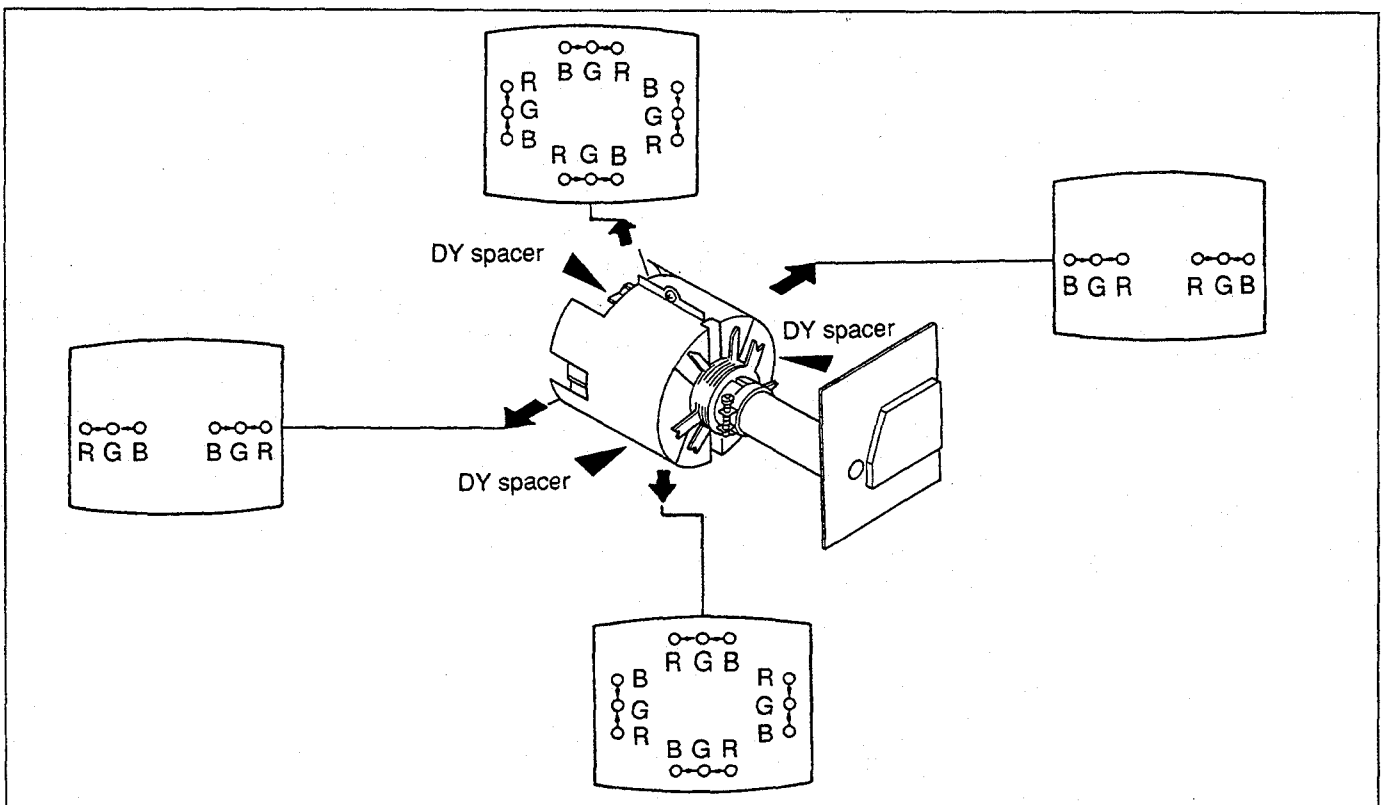

Screen-corner Convergence

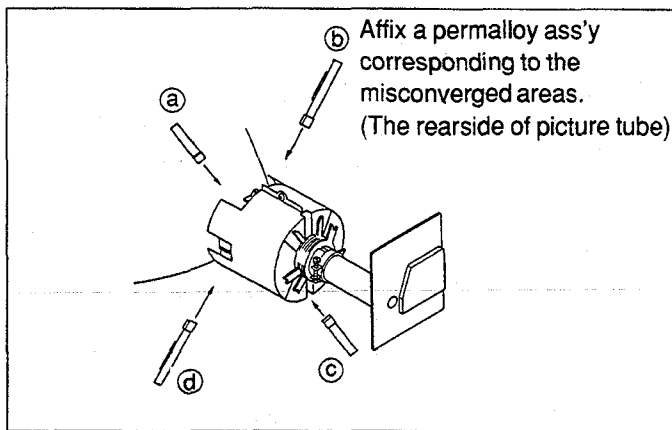
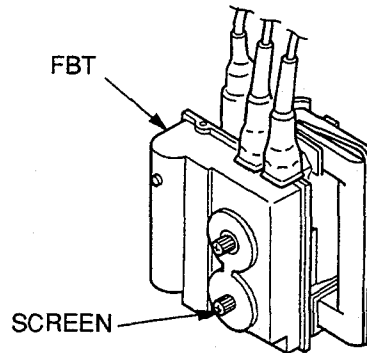
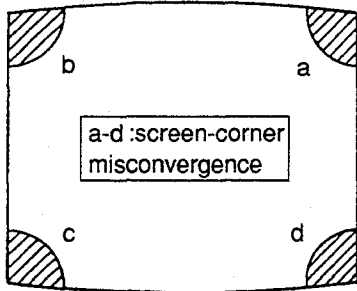

[White Balance]

1. Receive a color-bar pattern signal with the pattern generator. (Make black and white screen by chroma switch off.)
2.
 - BRIGHTNESS 50%
 - CONTRAST Minimum
 - CHROMA 50%
 - DRIVE control Mechanical center
 - BKG control Mechanical center
3. Adjust RV118 (SUB BRT) on B board so that the blue stripe portion on the color-bar pattern signal is bright dimly.

color-bar pattern

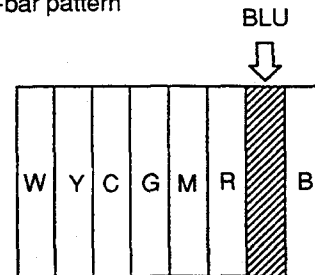

3-3. FOCUS

1. Receive the broadcast.
2. CONTRAST → Normal
3. Adjust FOCUS control so that the focus on the center of screen becomes to the best.

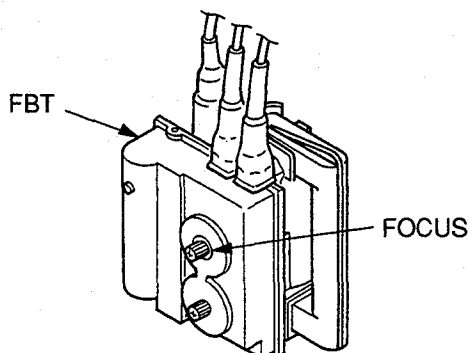

3-4. WHITE BALANCE

[Screen (G2) Voltage Adjustment]

1. Receive a dot signal with the pattern generator.
2. Adjust R. G. B cut-off controls so that respective cathode voltage against ground becomes 103V DC.
3. Observing the screen, adjust SCREEN control so that the background of the dot signal is bright dimly.

4. Receive an entirely white signal from the pattern generator.
5. CONTRAST 70% (90 degree clockwise from mechanical center.)
6. Using the luminance level meter, adjust the luminance level of the pattern generator becomes 3 Nits. (The condition the screen is bright dimly.)
7. Adjust white balance at cut-off using RV119 (G-C/O) and RV121 (B-C/O).
8. Change the all-white signal luminance level to 100 IREs.
9. Adjust white balance at high-light using RV120 (G-GAIN) and RV121 (B-GAIN).
10. Change the unit to blue ONLY mode.
11. Adjust white balance (at high-light) in blue ONLY mode using RV124 *R-GAIN/BL) and RV125 (G-GAIN/BL).
12. Using the luminance level meter, adjust the luminance level of the pattern generator becomes 8 Nits. Confirm that white balance at cut-off is satisfactory..

SECTION 4 SAFETY RELATED ADJUSTMENT

4-1. SAFETY RELATED ADJUSTMENTS

B+ ADJUSTMENT AND B+ MAX CHECK FOR SERVICING
(RV651)

The following adjustments should always be performed when replacing the following components (marked with on the schematic diagram).

on G board : (Power supply block)

IC601, IC651, PH601, C654, R653, R655, R656, R657, RV651.

1. Input the AC power supply voltage $240V_{-0}^{+1}$ V.
2. Input the monoscope signal.
3. Set as follows.
 - CONTRAST 80%
 - BRIGHTNESS 50%
4. Connect the digital multimeter to RY1601 pin-⑦ on the D board.
5. Adjust RV651 on the G board so that the +B voltage becomes 40.0 ± 0.1 V.
6. After adjusting RV651, fix it with an epoxy.
7. Input the AC power supply voltage $240V_{-0}^{+1}$ V.
8. Input the dot signal.
9. Set as follows.
 - CONTRAST Minimum
 - BRIGHTNESS Minimum
10. Check that the B+ voltage is below 41.9V.
If it is above this value, repeat from step 1.

B+ MAX IN DC POWER INPUT MODE, CONFIRMATION
(RV1603)

The following adjustments should always be performed when replacing the following components (marked with on the schematic diagram).

on D board :

Q1601, Q1602, Q1603, D1601, D1602, D1603, D1604, D1605, C1601, C1602, R1601, R1602, R1603, R1604, R1605, R1606, R1607, R1608, R1629, R1628, R1630, RV1601, RV1603.

1. Supply DC $12V_{-0}^{+0.4}$ V from DC 12V IN connector.
2. Receive a dot signal.
3. • CONTRAST Minimum
• BRIGHTNESS Minimum
4. Connect a digital multimeter to C1605 positive + side of D board.
5. Turn RV1601 on the D board fully clockwise. Confirm that the voltage of C1605 + pin is less than 41.9V DC.
6. If step 5 is not satisfied, readjust the RV1603. After adjusting, fasten RV1603 in place with epoxy.

HOLD-DOWN CIRCUIT CONFIRMATION (RV833) AND READJUSTMENTS

The following adjustments should always be performed when replacing the following components (marked with on the schematic diagram).

on D board:

IC502, Q833, Q834, Q835, Q836, D835, D836, C519, C843, C844, C845, C846, C847, C848, RV833, R523, R850, R851, R852, R853, R854, R855, R856, R857, R858, R859, R861, R862, R863.

on P board: NL801, T802 (FBT), C814.

1. Receive an entire white signal.
2. • CONTRAST Maximum
• BRIGHTNESS Maximum
3. Connect a digital multimeter to the TP85 (CN503 pin-⑥).
4. Confirm the voltage is 14.1 ± 3.0 V DC.
5. Receive a dot signal.
6. Connect an ammeter between D board CN503 pin-⑧ and P board CN801 pin-⑧.
7. Adjust BRIGHTNESS and CONTRAST so that the current is $IABL = 160 \pm 30 \mu A$.
8. Apply an external DC voltage gradually to TP85. When the voltage becomes $18.5V \pm 0.1$ V DC, confirm the HOLD-DOWN circuit operates immediately and raster disappears.
9. When external DC voltage at TP85 becomes $17.5V \pm 0.1$ V DC, confirm the HOLD-DOWN circuit doesn't operate.
10. Receive an entire white signal.
11. Adjust with BRIGHTNESS and CONTRAST controls so that the current is $IABL = 520 \pm 30 \mu A$.
12. Apply DC voltage of $17.8V \pm 0.1$ V to TP85. Confirm the HOLD-DOWN circuit operates immediately and raster disappears.
13. With the same set-up as steps 10 and 11, supply $16.8V \pm 0.1$ V DC to TP85. Confirm that the HOLD-DOWN circuit doesn't operate.
14. When above specifications are not satisfied, readjust RV833. After adjusting, fasten RV833 in place with epoxy.

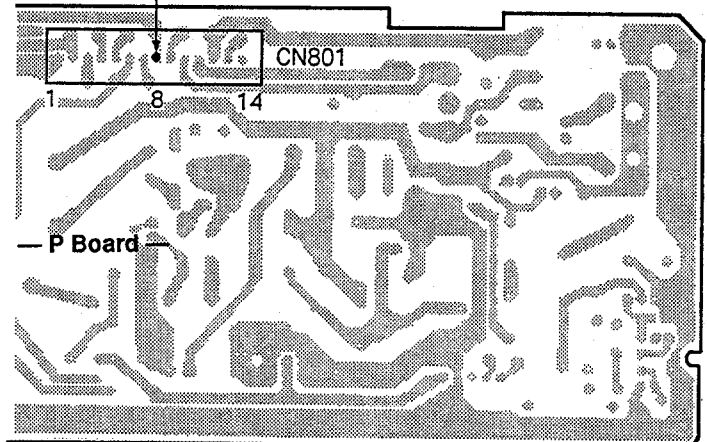
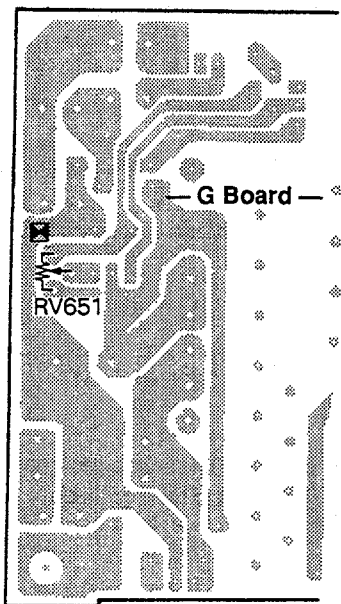
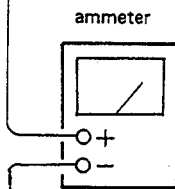
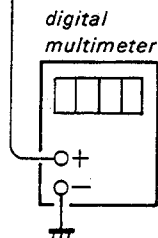
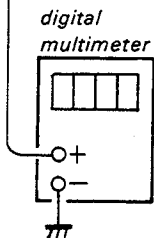
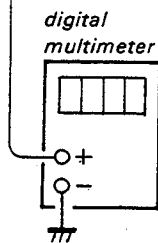
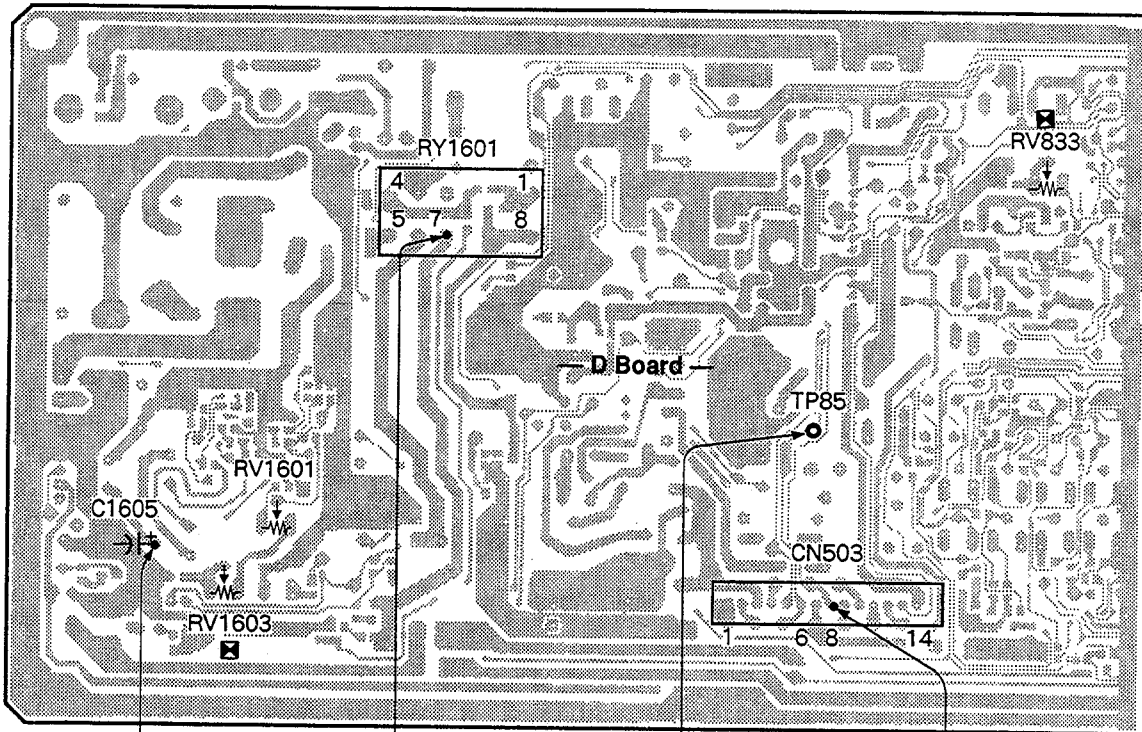

SECTION 5 CIRCUIT ADJUSTMENTS

5-1. D BOARD ADJUSTMENTS

—D BOARD (COMPONENT SIDE)—

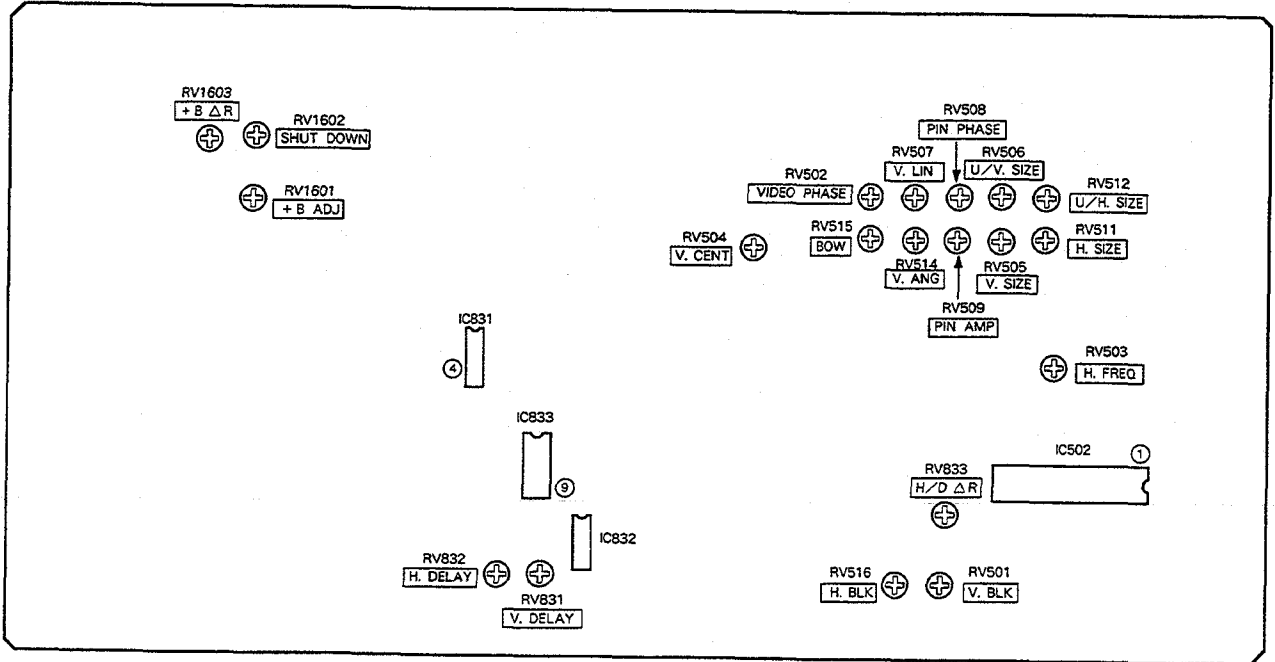

HORIZONTAL OSCILLATION FREQUENCY ADJUSTMENT (RV503)

1. Receive a monoscope signal.
2. Connect pin-① of IC502 to ground with 100 μ F/16V electrolytic capacitor.
3. Adjust RV503 (H.FREQ) so that the screen streaming to stops.

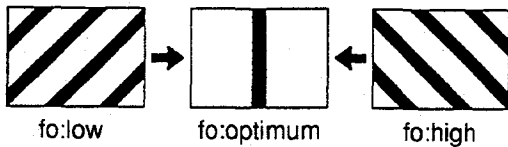

SCREEN PHASE ADJUSTMENTS (RV502, RV512, RV516)

1. Receive a monoscope signal.
2. Set U/S (Under Scan) switch to Under mode.
3.
 - CONTRAST Minimum
 - BRIGHTNESS Maximum.
4. Adjust RV512 (U/H. SIZE) so that the white frame of monoscope signal becomes visible.
5. Adjust RV516 (H.BLK) for minimum BLKG width so that all the deflection area becomes visible.
6. Adjust RV502 (VIDEO PHASE) so that the monoscope's white frames should have equal width.

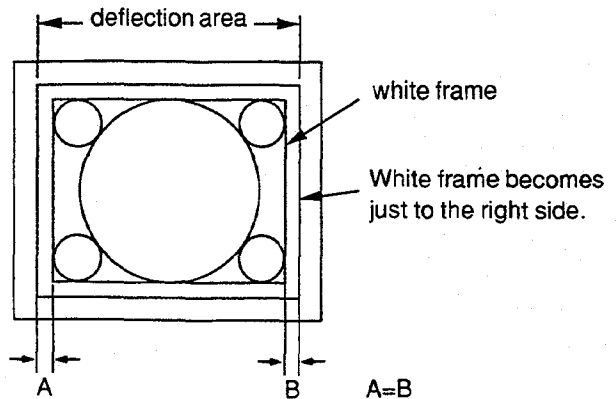

H.V BLK ADJUSTMENTS (RV501,RV516)

1. Receive a monoscope signal.
2. Set U/S (Under Scan) switch to Under mode.
3. • CONTRAST Minimum
• BRIGHTNESS Maximum.
4. V. BLK Adjustment (RV501)
 - (1) Adjust RV501(V. BLK) so that the upper side white frame of monoscope signal is not blanked.

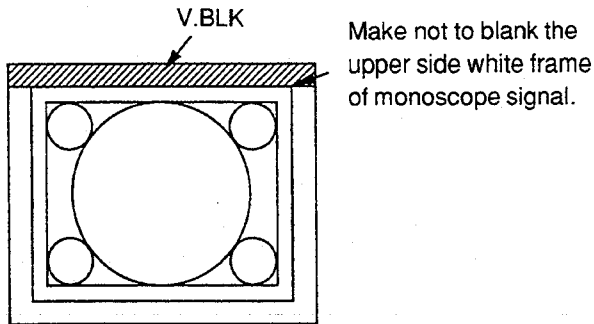

5. H. BLK Adjustment (RV516)
 - (1) Adjust with RV516 (H. BLK) so that the left end white vertical line of the white frame of monoscope signal is not blanked as following figure.

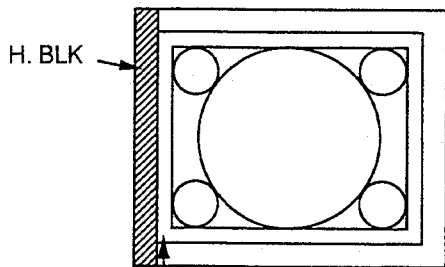

Make not to blank the left end white vertical line of the white frame of monoscope signal.

VERTICAL DEFLECTION PART ADJUSTMENTS (RV504, RV505, RV506, RV507)

1. Receive a monoscope signal.
2. • CONTRAST 70%
• BRIGHTNESS 50%
3. Adjust RV505 (V. SIZE) so that the vertical size of monoscope signal becomes 12 frames.

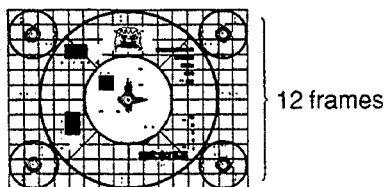

4. Adjust RV507 (V.LIN) the vertical linearity.

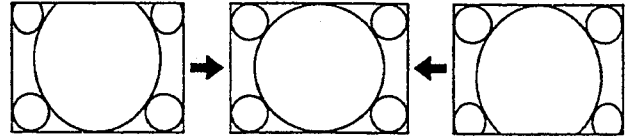

5. Adjust RV504 (V. CENT) the vertical position.

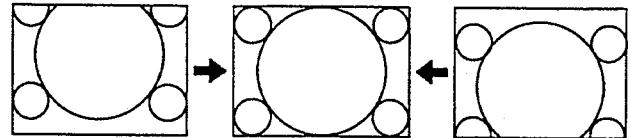

6. V. SIZE ADJUSTMENT (RV505)
 - (1) Adjust RV505 (V. SIZE) so that the vertical size of monoscope signal becomes 11.75 +0.2 frames.
7. V.SIZE IN UNDERSCAN MODE ADJUSTMENT (RV506)
 - (1) Set U/S (Under Scan) switch to Under mode.
 - (2) Adjust the Under V.SIZE with RV506 (U/V. SIZE) as follows.

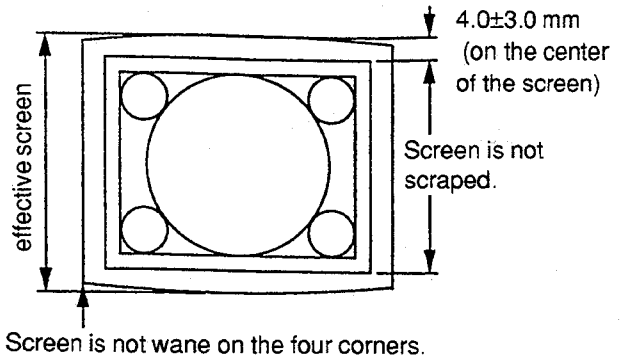

HORIZONTAL DEFLECTION PART ADJUSTMENTS (RV508, RV509, RV511, RV514, RV515, RV801/P board)

1. Receive a monoscope signal.
2. • CONTRAST 70%
• BRIGHTNESS 50%
3. H. CENT Adjustment (RV801 on P board)
 - (1) Adjust RV801 on P board (H. CENT) the horizontal position.

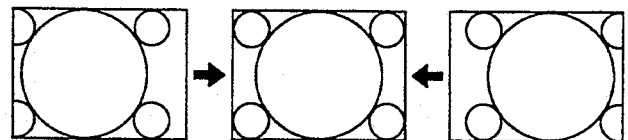

4. H. SIZE Adjustment (RV511)
 - (1) Adjust RV511 (H. SIZE) the horizontal size of 16 frames of monoscope signal.

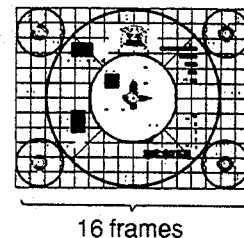

5. PIN AMP. PIN PHASE. V. ANG, BOW ADJUSTMENTS (RV508 RV509, RV514, RV515)

Adjust RV514 (V. ANG) and RV515 (BOW) to correct vertical angular distortion and bow distortion. Adjust RV509 (PIN AMP) and RV508 (PIN PHASE) so that vertical lines become straight.

- V. ANG (RV514)

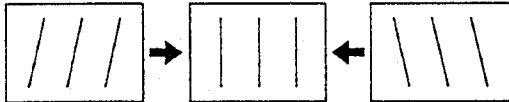

- BOW (RV515)

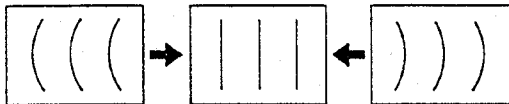

- PIN AMP (RV509)



- PIN PHASE (RV508)

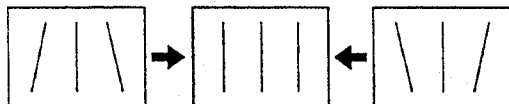

6. H. SIZE ADJUSTMENT (RV511)

- (1) Adjust RV511 (H. SIZE) so that the horizontal size becomes 16 ± 0.2 frames.

7. UNDERSCAN MODE H. SIZE ADJUSTMENT (RV512)

- (1) Set U/S (Under Scan) switch to Under mode.
- (2) Adjust RV512 (U/H. SIZE) the Under H. SIZE as shown in the figure.

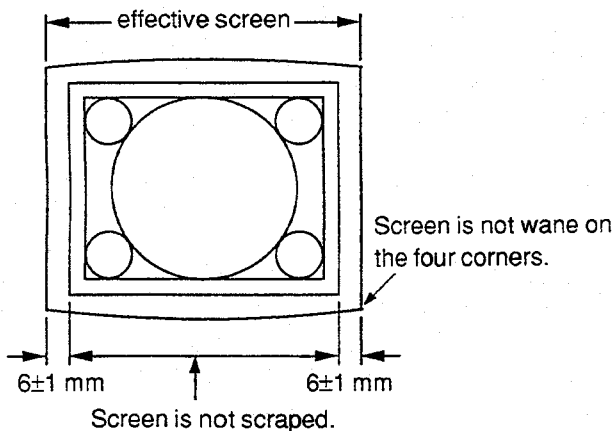

H V DELAY ADJUSTMENT (RV831, RV832)

1. Receive a monoscope signal.
2. • CONTRAST 70%
• BRIGHTNESS 50%
3. Set H V DELAY switch to DELAY mode.
4. H. DELAY Adjustment (RV832)
 - (1) Connect an oscilloscope to pin-④ of IC831.
 - (2) Adjust RV832 (H. DELAY) to become $41 \pm 1 \mu\text{sec}$.

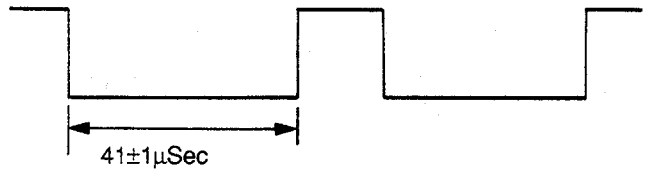

5. V. DELAY Adjustment (RV831)
 - (1) Connect an oscilloscope to pin-⑨ of IC833.
 - (2) Adjust RV831 to become $8.0 \pm 0.4 \text{msec}$ as follows.

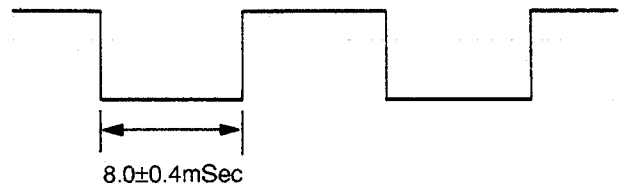

SHUT-DOWN VOLTAGE ADJUSTMENT (RV1602)

1. Fully rotate RV1602 in the direction that does not shut-down.
2. Supply a $9.4V \pm 0.1V$ voltage to the C1602 side of L1602 on the D board.
3. Turn AC power switch ON.
4. Rotate D board RV1602 (SHT DOWN) slowly to the point that shuts-down the unit.

B+ VOLTAGE DURING DC OPERATE MODE, ADJUSTMENT (RV1601)

1. Supply $DC12V \pm 0.2V$ to DC 12V IN connector.
2. Receive a monoscope signal.
3. • CONTRAST 80%
• BRIGHTNESS 50%
4. Connect a digital voltmeter to C1605 + positive side on D board.
5. Adjust RV1601 on the D board for $40.0 \pm 0.1V$ DC.

B BOARD ADJUSTMENT

-B BOARD (COMPONENT SIDE)-

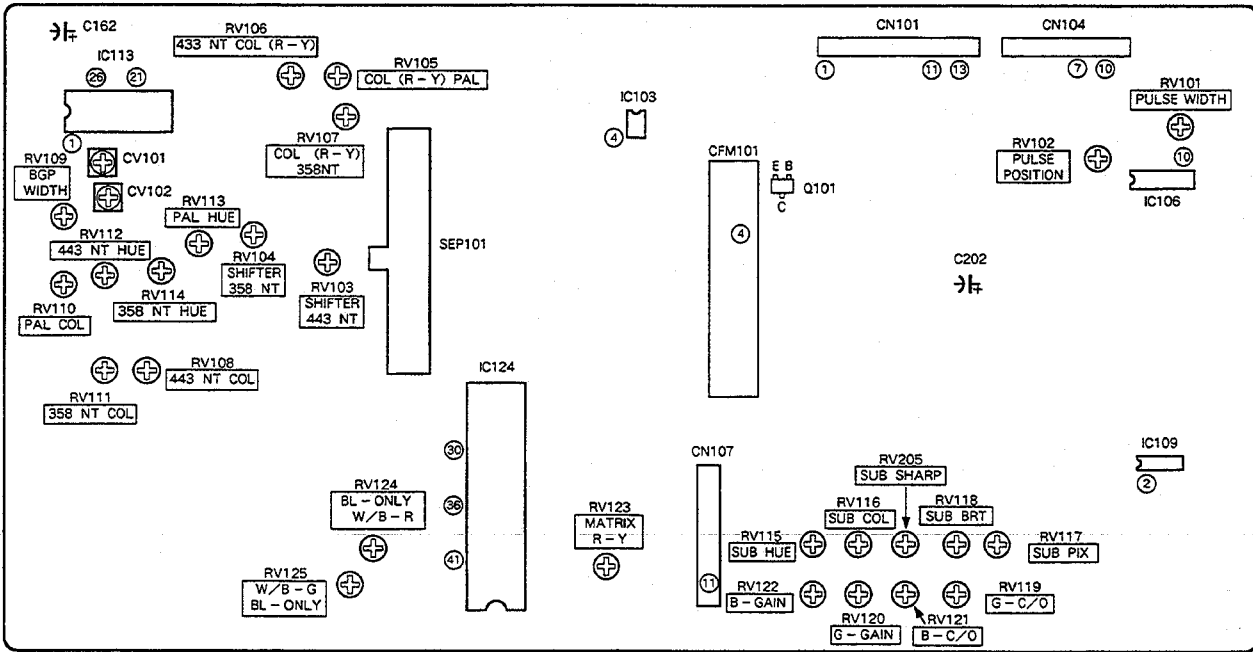

-B BOARD (CONDUCTOR SIDE)-

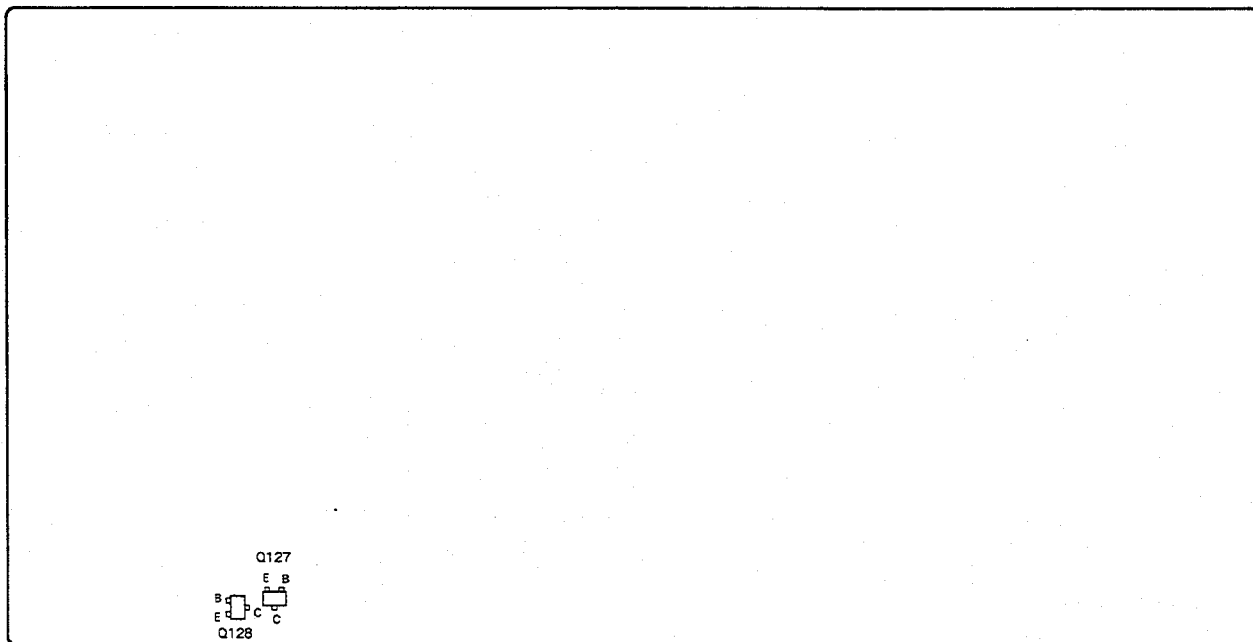

**PRIMARY COLOR MATRIX ADJUSTMENT
(RV115, RV116, RV123)**

1. Supply component color bar signal (75% chroma color bar) to the equipment so that Y signal is supplied to EXT SYNC and R-Y signal to R-Y connectors. Operate the equipment in external sync mode.
2. Connect oscilloscope to IC124 pin-30 (B-OUT).
3. Adjust RV115 (SUB HUE) to obtain the Blue output as shown in figure.

(B-OUT)

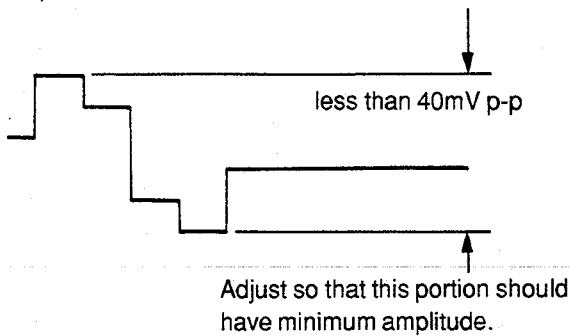

4. Supply component color bar signal (75% color bar) to the component input connector to feed R-Y and B-Y signals. Operate the equipment in internal SYNC mode.
5. Connect oscilloscope to IC124 pin-30 (SUB-COL). Adjust RV116 (SUB-COL) so that waveform peaks should have the same level.

(B-OUT)

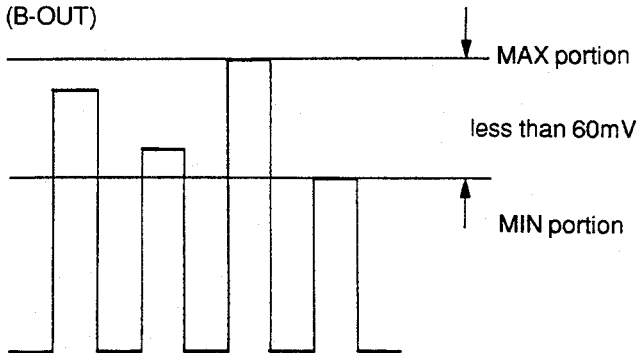

(Adjust so that the first and the 4th peaks should have the same level.)

6. Connect oscilloscope to IC124 pin-41 (R-OUT).
7. Adjust RV123 ((R-Y)-IN) so that waveform peaks should have the same level.

(R-OUT)

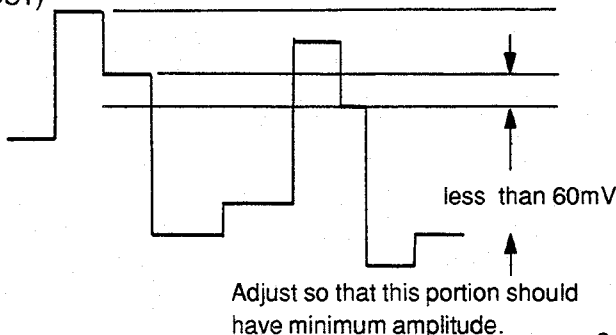

BURST GATE PULSE WIDTH ADJUSTMENT (RV109)

1. Receive color bar signal.
2. Connect dual trace oscilloscope to CN104 connector pin-10 (COMP-SYNC) and IC113 (M51279) pin-1 (BGP-WIDTH). Adjust RV109 (BGP-WIDTH) to obtain the relationship as shown in the figure.

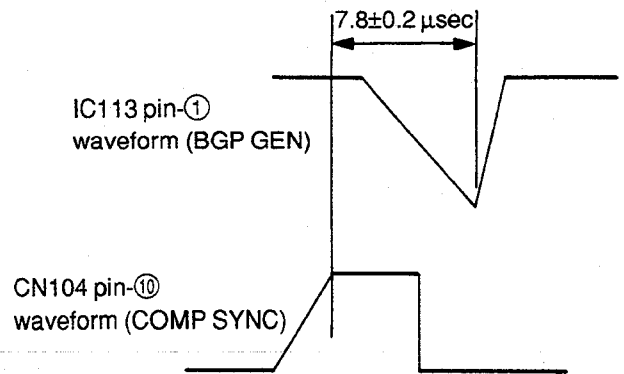

VXO ADJUSTMENT (CV101, CV102)

1. 3.58MHz VXO adjustment (CV101)
 - (1) Receive NTSC color bar signal.
 - (2) Connect +5V power line to IC113 pin-26 (ID-FILT-REF) via a 4700Ω resistor.
 - (3) Ground IC109 pin-2 by connecting it to ground.
 - (4) Ground C162 - negative side by connecting it to ground.
 - (5) Connect frequency counter to IC113 pin-21. Adjust CV101 (358FO) for 3579545±20Hz. (This adjustment can be alternatively done by observing screen as below.)

Adjust color synchronization by CV101 (358FO).

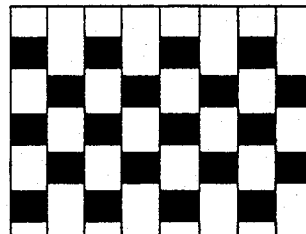

Adjust so that color stripes disappear and the hue change is stabilized extremely.

2. 4.43MHz VXO adjustment (CV102)
 - (1) Receive PAL colour bar signal.
 - (2) Connect +12V power line to IC109 pin-②.
 - (3) Connect frequency counter to IC113 pin-⑳. Adjust CV102 (443FO) for 4433619±20Hz.
(This adjustment can be alternatively done by observing screen as below.)

Adjust colour synchronization by CV102(443FO).

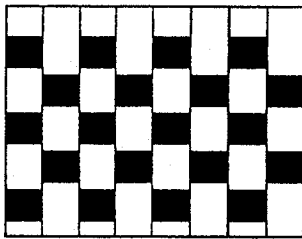

Adjust so that colour stripes disappear and the hue change is stabilized extremely.

NTSC COMB FILTER ADJUSTMENT (RV1,T1/CFM101 BOARD)

1. Receive NTSC 3.58 color bar signal.
2. Connect an oscilloscope to C202 – negative side.
3. Confirm the Y OUT is 0.78±0.5 Vp p.
4. Confirm the residual chroma is 32 mVp-p below. If it is above 35 mVp p, adjust with RV1 and T1 on CFM201 board while tracking.

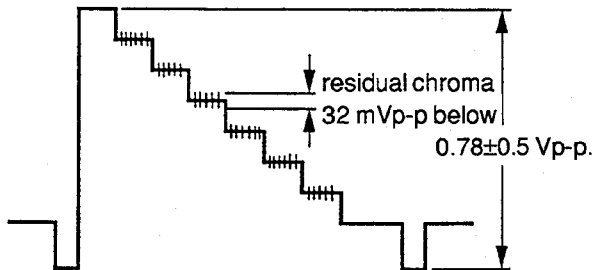

NTSC COLOR DEMODULATION ADJUSTMENT (RV114,RV111,RV104,RV107)

1. NTSC 3.58MHz - HUE adjustment (RV114)
 - (1) Supply NTSC color bar signal including burst and R-Y component. (For example, Tektronix 1410SG output color bar signal with B-Y component removed.)
 - (2) Connect an oscilloscope to Q128 emitter (B-Y OUT).
 - (3) Adjust RV114 (358NT - HUE) so that all the waveform peaks should have equal amplitude (look flat) except burst. (Level difference should be less than 10mV p-p.)

2. NTSC 3.58MHz - COLOR adjustment (RV111)
 - (1) Receive NTSC 3.58 color bar signal.
 - (2) Connect an oscilloscope to IC124 pin-⑳ (B-OUT).
 - (3) Adjust RV111(358NT-COL) so that waveform peaks should have the same level (most flat).

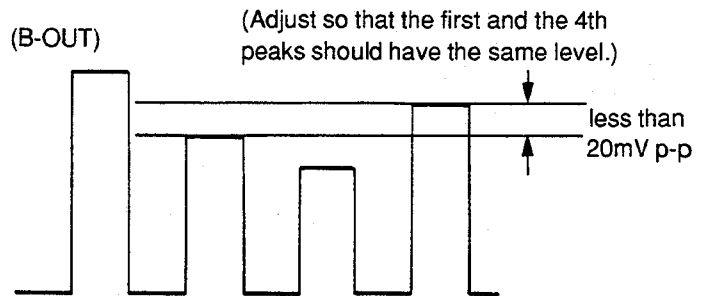

3. NTSC 3.58MHz - COLOR (R-Y) adjustment (RV104, RV107)
 - (1) Receive the color bar signal.
 - (2) Connect an oscilloscope to the Q127 emitter (R-Y OUT), and adjust RV104 (358NT-SHIFT) so that the output of the burst section (B-Y axis signal output) becomes 0.
 - (3) Connect an oscilloscope to IC124 pin-㉑ (R-OUT). Adjust RV107 (358NT-COL (R-Y)) so that the level difference should be minimum.

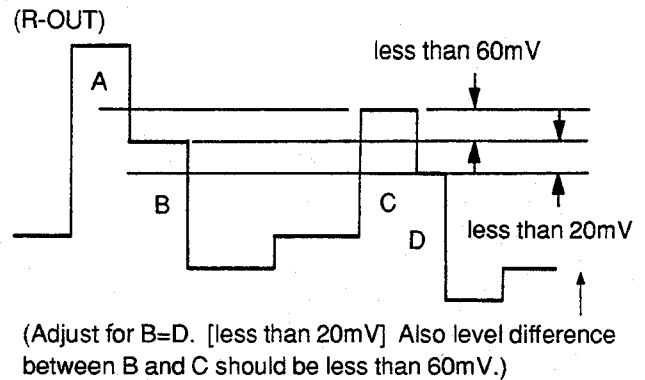

NTSC 4.43MHZ COLOR DEMODULATION ADJUSTMENT (RV108,RV112,RV103,RV106)

1. NTSC 4.43MHz - COLOR adjustment (RV108,RV112)
 - (1) Receive NTSC 4.43 color bar signal (75% color bar).
 - (2) Connect an oscilloscope to IC124 pin-39 (B-OUT).
 - (3) Adjust RV108 (443NT-COL) so that waveform peaks should have the same level (most flat).

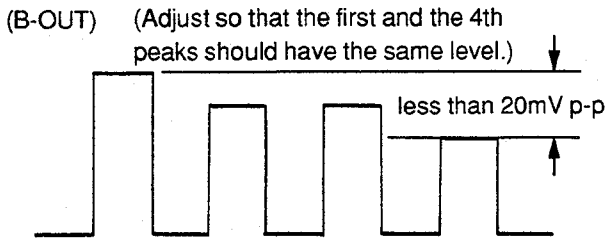

- (4) When cyan and magenta have level difference, adjust RV112 (443NT-HUE) and RV108 (443NT-COL) alternatively to remove, by tracking.

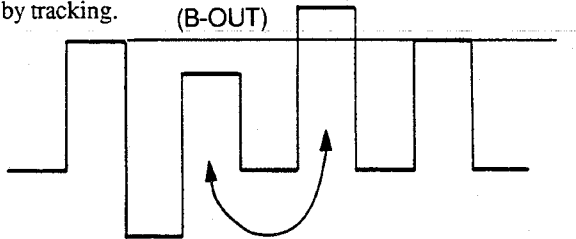

When cyan and magenta have level difference, adjust RV112 and RV108 alternatively to remove.

2. NTSC 4.43MHz - COLOR (R-Y) adjustment (RV103, RV106)
 - (1) Receive the NTSC 4.43 color bar signal (75%, chroma color bar).
 - (2) Connect an oscilloscope to the Q127 emitter (R-Y OUT), and adjust RV103(443NT-SHIFT) so that the output of the burst section (B-Y axis signal output) becomes 0.
 - (3) Connect an oscilloscope to IC124 pin-41 (R-OUT). Adjust RV106 (443NT-COL (R-Y)) so that the level difference should be minimum.

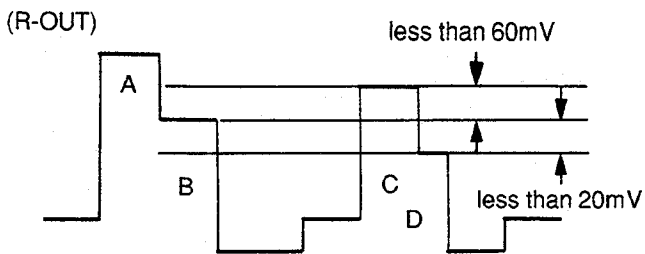

(Adjust for B=D. [less than 20mV] Also level difference between B and C should be less than 60mV.)

PAL COLOR DEMODULATION ADJUSTMENT (RV113,RV2/SEP101, RV110,RV105,RV205)

1. PAL PHASE Adjustment (RV113,RV2/SEP101)
 - (1) Receive the special PAL color-bar.
 - (2) Connect an oscilloscope to emitter of Q127 (R-Y OUT).
 - (3) Adjust RV113 (PAL-PHASE) so that B-Y (0/180°) anti-PAL portion (in the R-Y demodulated output) becomes "0" (flat) as following figure.

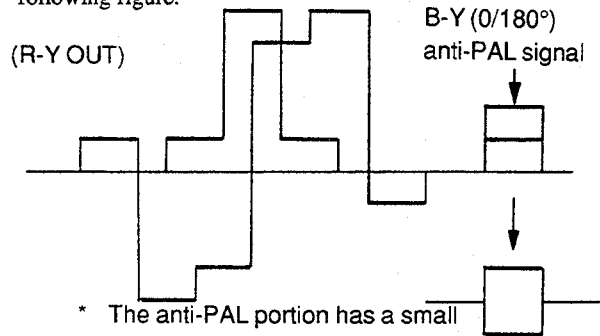

* The anti-PAL portion has a small level difference in every other horizontal period. So, adjust so that average becomes "0".

- (4) Connect an oscilloscope to emitter of Q128 (B-Y OUT).
- (5) Adjust RV2 inside SEP101 so that R-Y (90°/90°) anti-PAL portion (in B-Y demodulated output) becomes "0" (flat) as following figure.

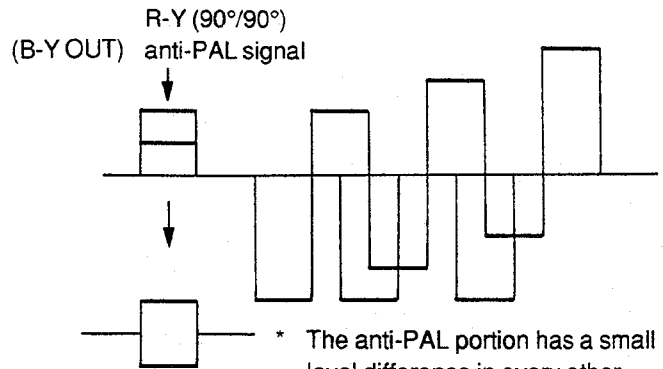

* The anti-PAL portion has a small level difference in every other horizontal period. So, adjust so that average becomes "0".

(For the adjustments of (3) and (5), it is also possible to set the color level to MAX with the chroma adjusting knob of the unit and erase the color of the anti-pal signal section.)

2. PAL COLOR ADJUSTMENT (RV110)

- (1) Receive PAL color bar signal (75% color bar).
- (2) Connect an oscilloscope to IC124 pin-30 (B-OUT).
- (3) Adjust RV110 (PAL-COL) so that waveform peaks should have the same level (most flat).

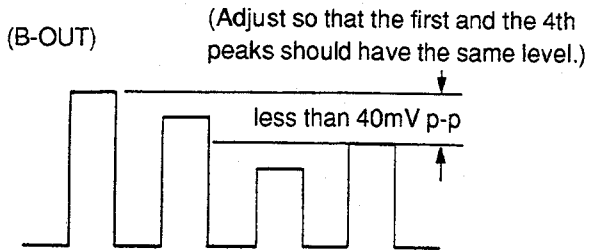

3. PAL-COLOR-(R-Y) ADJUSTMENT (RV105)

- (1) Connect an oscilloscope to IC124 pin-41 (R-OUT).
- (2) Adjust RV105 (PAL-COL-(R-Y)) so that waveform peaks should have the same level (most flat).

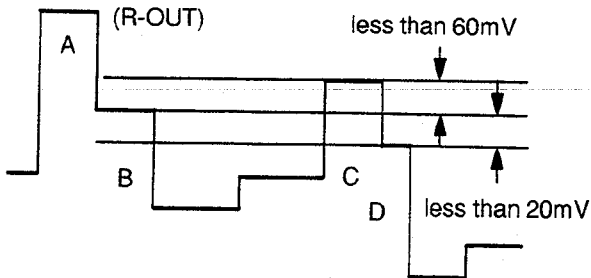

(Adjust for B=D. [less than 20mV] Also level difference between B and C should be less than 60mV.)

CHROMA H PULSE POSITION ADJUSTMENT (RV101, RV102)

- (1) Receive the SECAM color bar signal.
(The left edge of the screen should not be colored.)
- (2) Set to the under-scan mode.
- (3) Adjust RV101 (PLUSE-WIDTH) until the point immediately before the color on the left edge of the screen disappears.
- (4) Release the under-scan mode.
- (5) Set the HV DELAY mode.
- (6) Adjust RV102 (PULSE-POS) until the point immediately before the rising color of the image after back porch disappears.

Note : If image phase adjustment or HV DELAY amount adjustment during HV DELAY is performed after completing the adjustment in this section, re-adjustments will be required. Therefore, performed this adjustment after the two mentioned have been performed.

SUB-SHARP ADJUSTMENT (RV205)

- (1) Receive a sweep signal (or multi-burst).
 - * Bandwidth should be more than 10MHz (flat).
 - * Composite sync should be included.
 - * Turn burst off.
- (2) Connect an oscilloscope to IC124 pin-36 (G-OUT).
- (3) Adjust RV205 (SUB-SHARP) as shown.

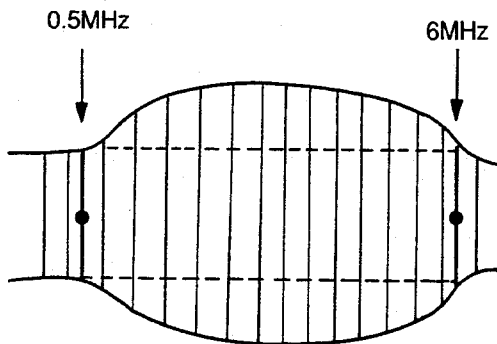

Example of sweep signal output waveform

[specification]
6MHz/0.5MHz=0±0.5dB

S BOARD ADJUSTMENTS

—S BOARD (COMPONENT SIDE)—

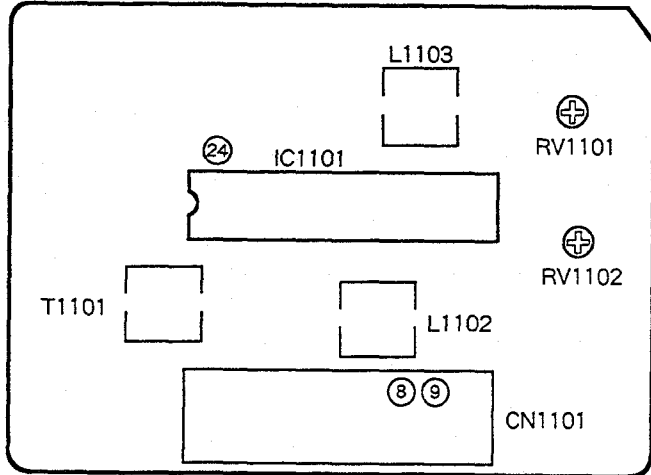

SECAM (T1101, L1102, L1103)

1. Receive SECAM color-bar.
2. Bell Filter Adjustment (T1101)
 - (1) Connect an oscilloscope to IC1101 pin-24.
 - (2) Adjust T1101 (Bell Filter) so that the chroma waveform becomes smooth. (Uneven level should be minimum.)

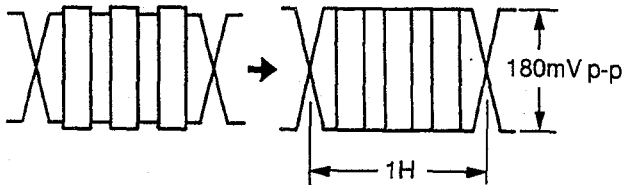

3. Color Balance Adjustment (L1102, L1103)
 - (1) Connect an oscilloscope to pin-9 (R-Y) of CN1101 connector.
 - (2) Adjust L1102 (R-Y) so that the non-colored portion level becomes flat.

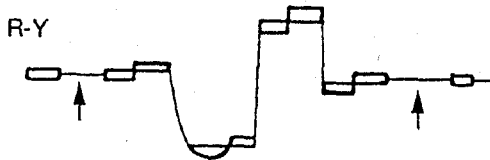

- (3) Connect an oscilloscope to pin-8 (B-Y) of CN1101 connector.
 - (4) Adjust L1103 (B-Y) so that the non-colored portion level becomes flat.



5. When adjusting the color level of the unit to MAX or MIN using the chroma adjusting knob, check that the white balance of the colorless section does not change.

DEMODULATION LEVEL ADJUSTMENT (RV1101, RV1102)

1. Receive SECAM color-bar.
2. Connect an oscilloscope to IC124 pin-30 (B-OUT).
3. Adjust S board RV1101 (SEC-COL) so that waveform peaks should have the same level (most flat).

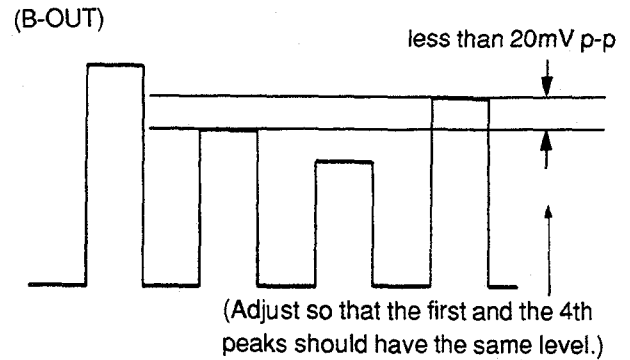

4. Connect an oscilloscope to IC124 pin-41 (R-OUT).
5. Adjust S board RV1102 (SEC-COL (R-Y)) so that the level difference should be minimum.

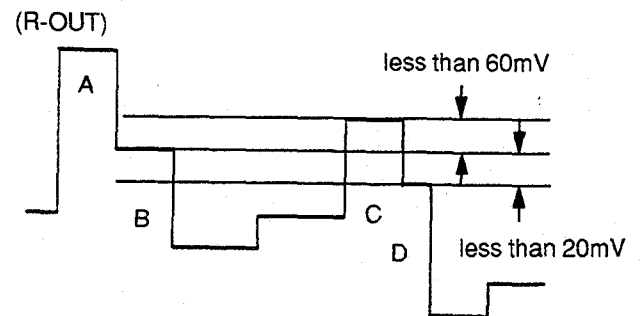

(Adjust for B=D. [less than 20mV] Also level difference between B and C should be less than 60mV.)

SECTION 6
DIAGRAMS

6-1. FRAME SCHEMATIC DIAGRAM

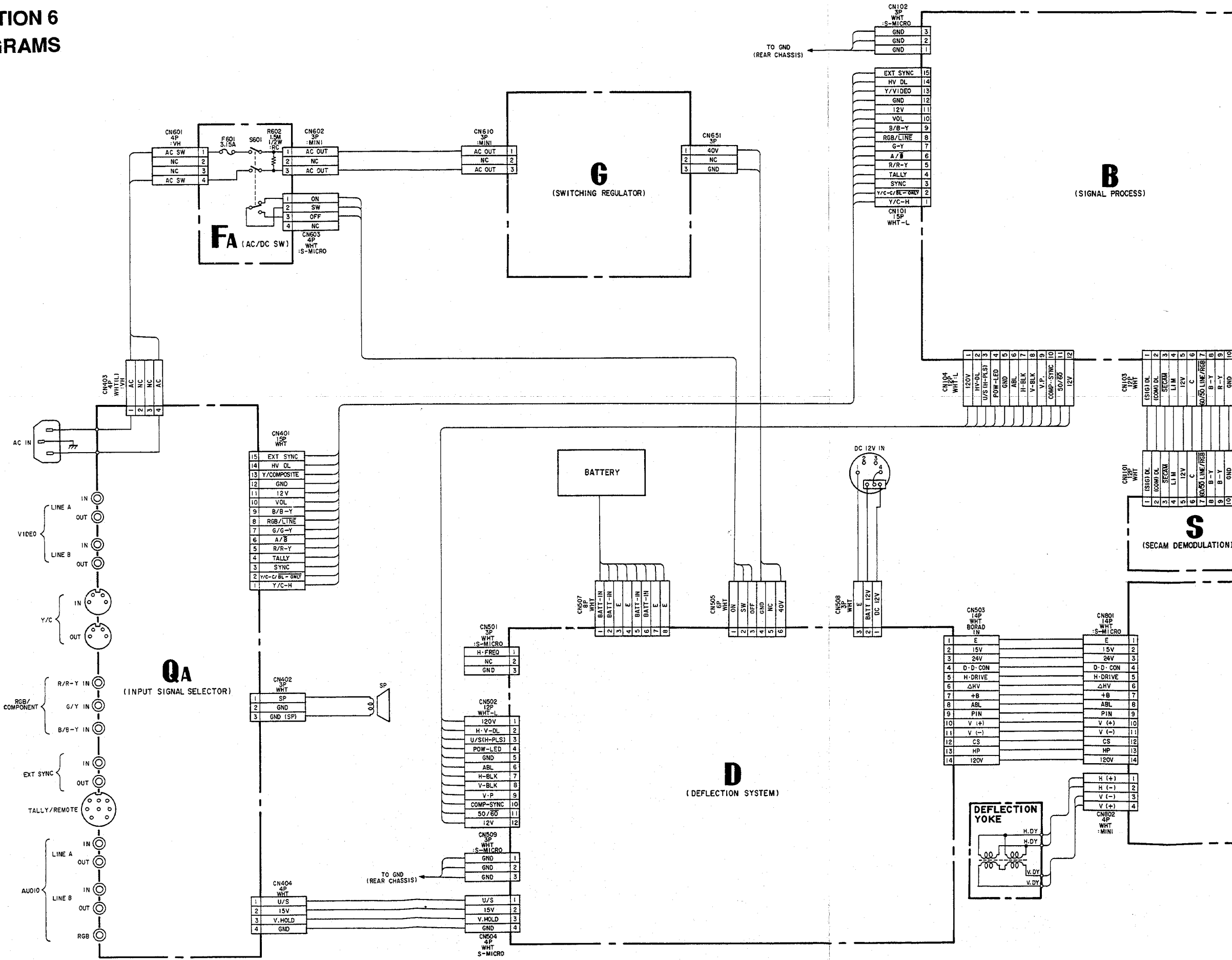

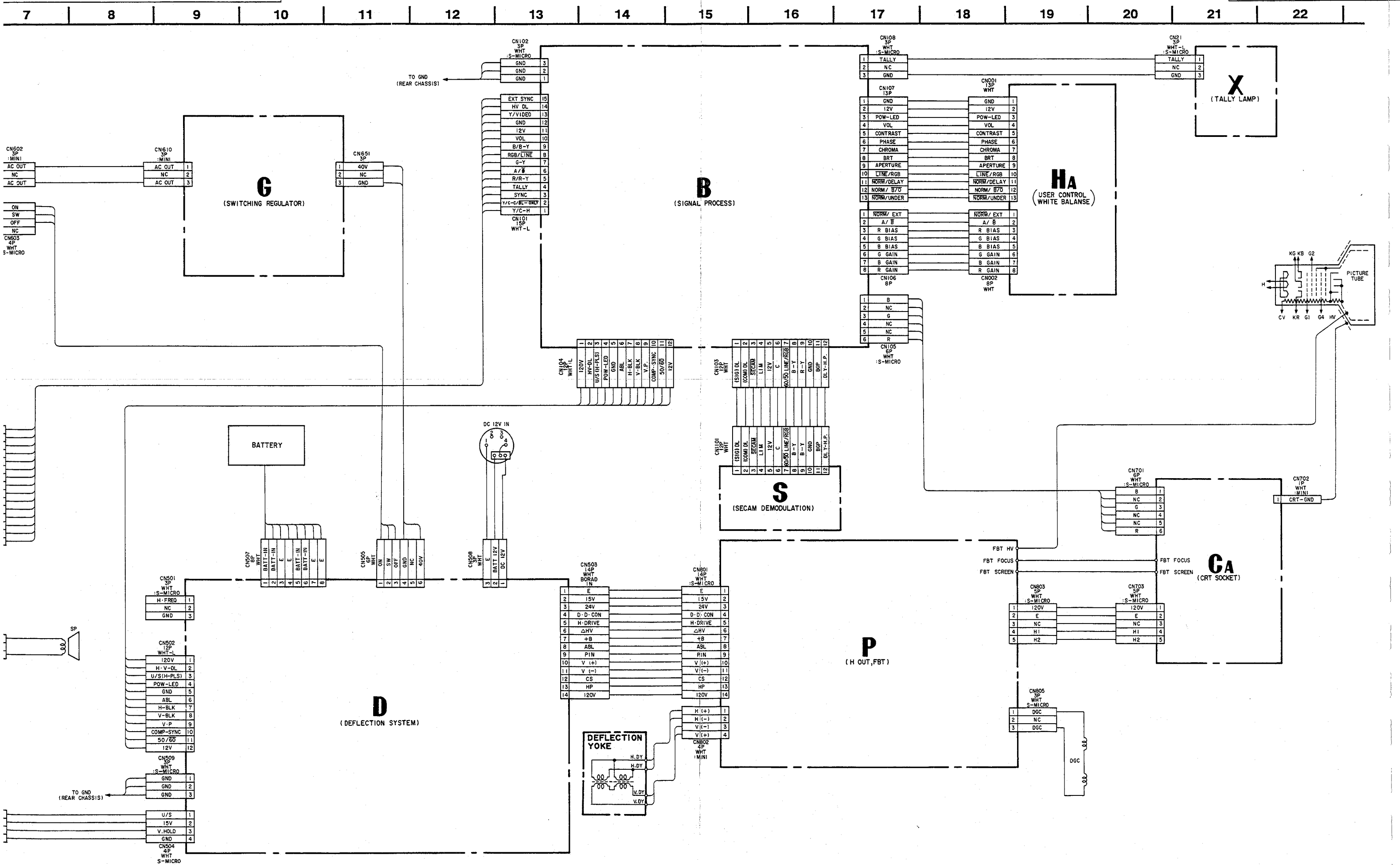

6-2. BLOCK DIAGRAM (1)

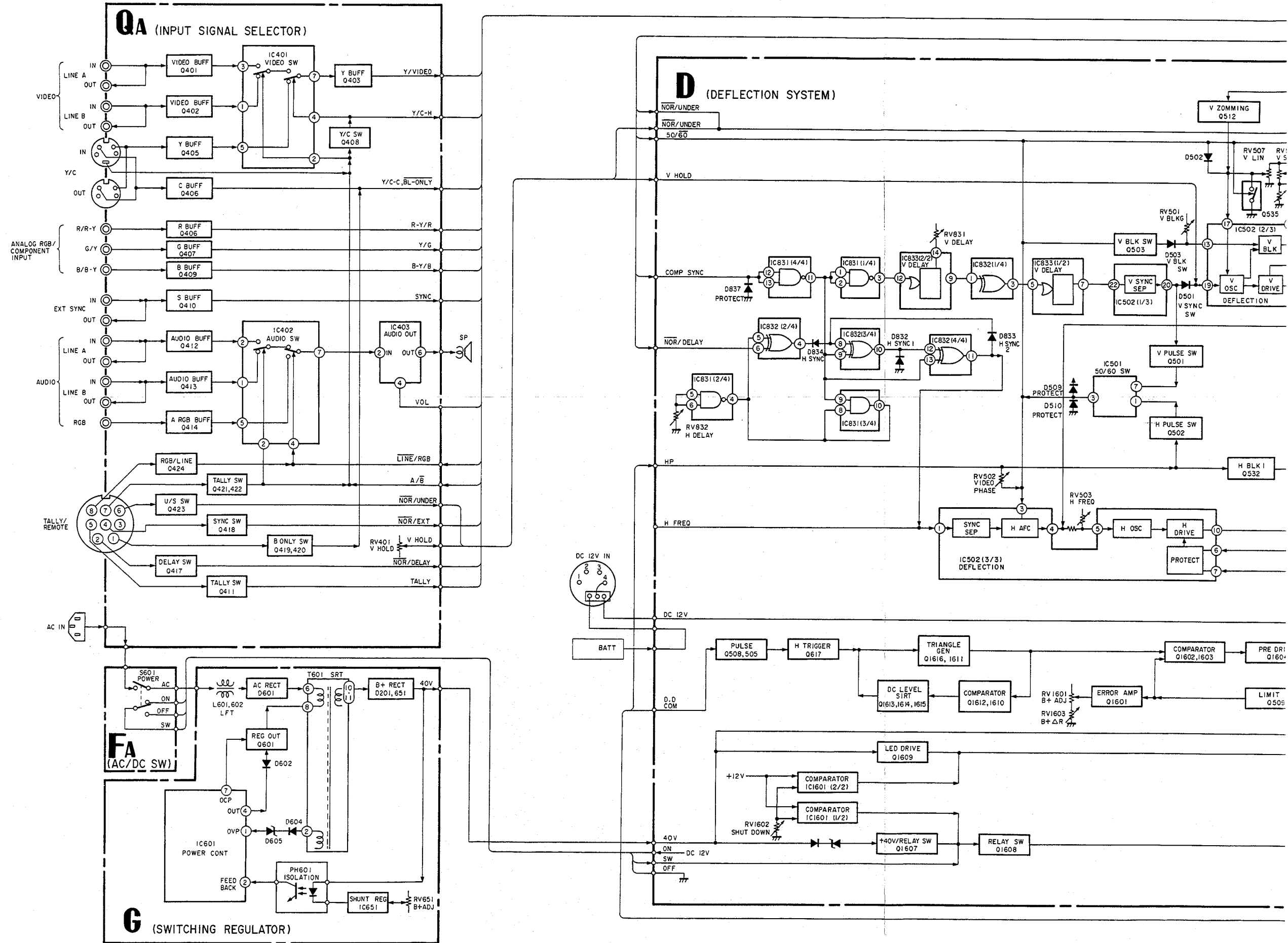

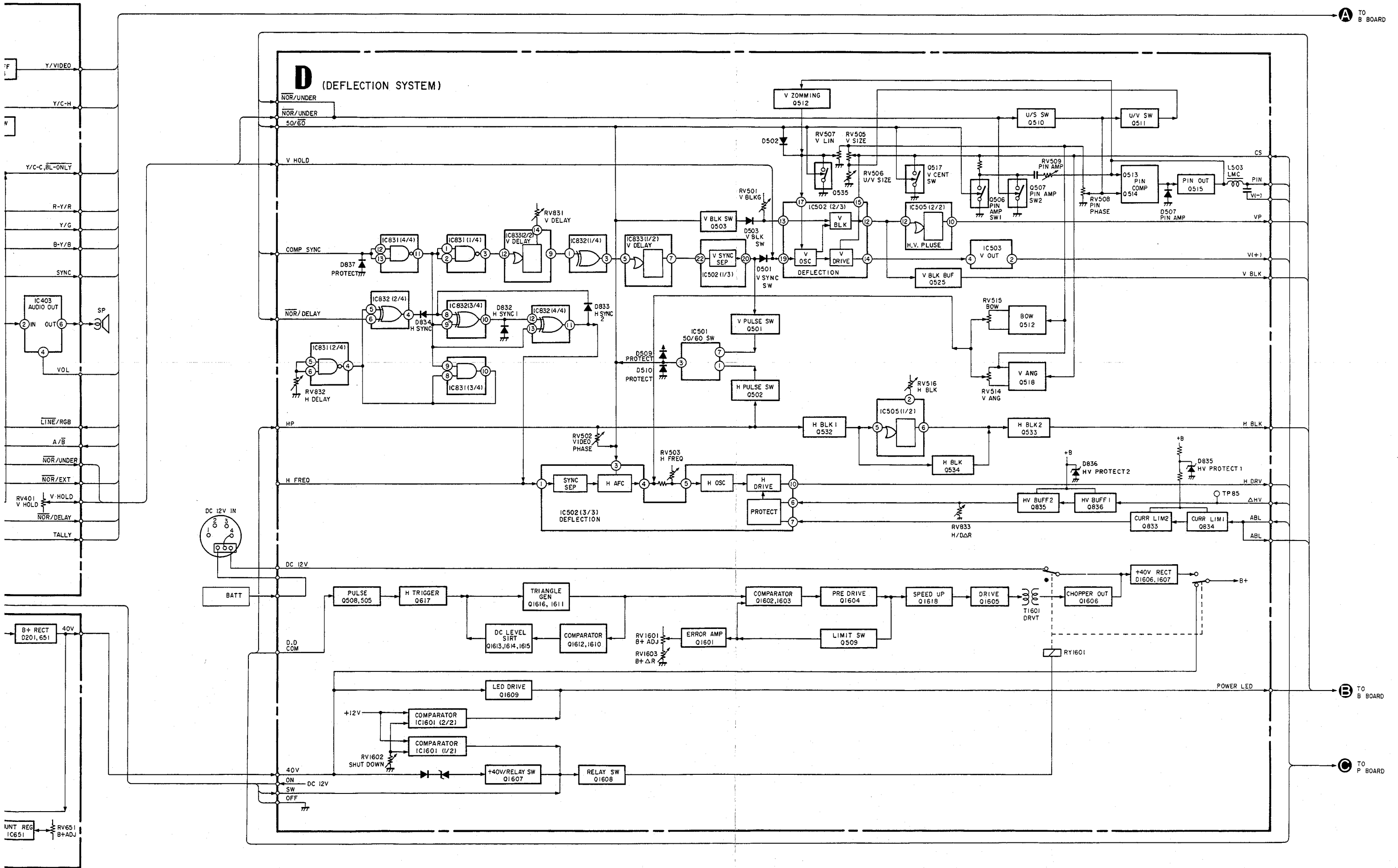

6-3. BLOCK DIAGRAM (2)

PVM-9041QM/9044QM PVM-9041QM/9044QM

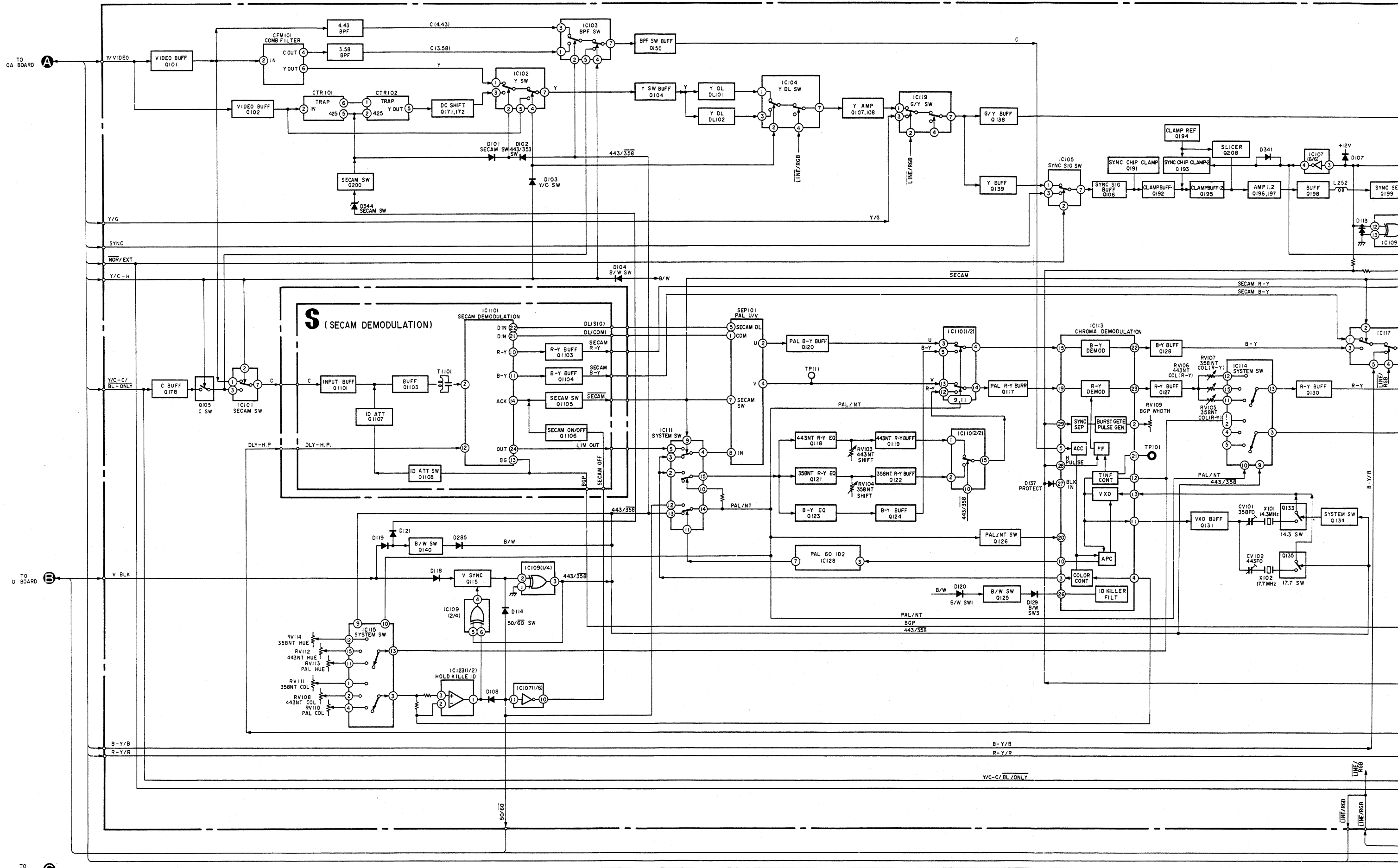

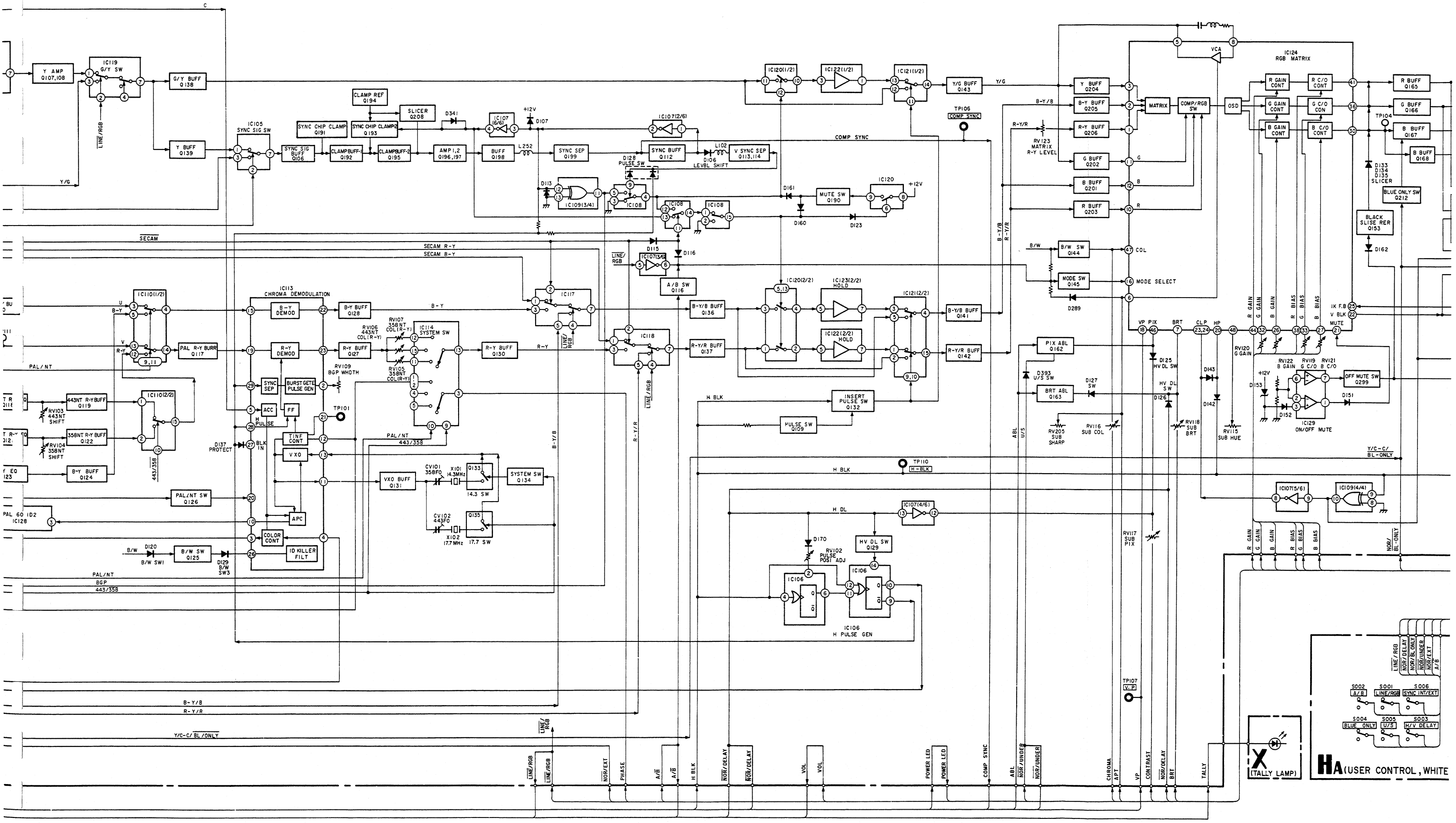

X (TALLY LAMP)

HA (USER CONTROL, WHITE)

S002 A/R
 S001 LINE/RGB
 S006 SYNC INT/EXT
 S004 BLUE ONLY
 S005 U/S
 S003 H/V DELAY
 LINE/RGB
 NOR/DELAY
 NOR/BL ONLY
 NOR/UNDER
 NOR/EXT
 NOR/BL ONLY
 A/B

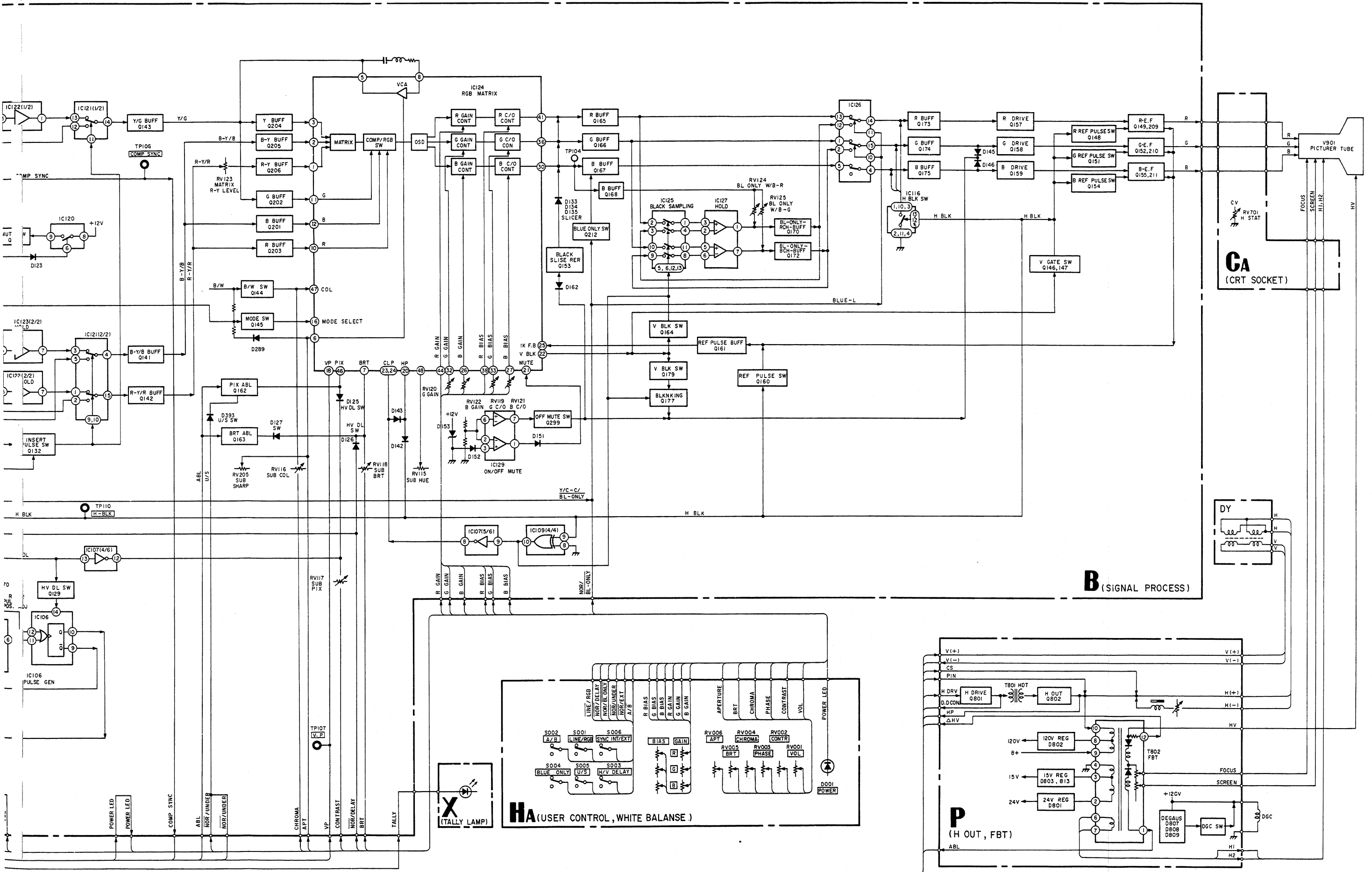

6-4. CIRCUIT BOARDS LOCATION

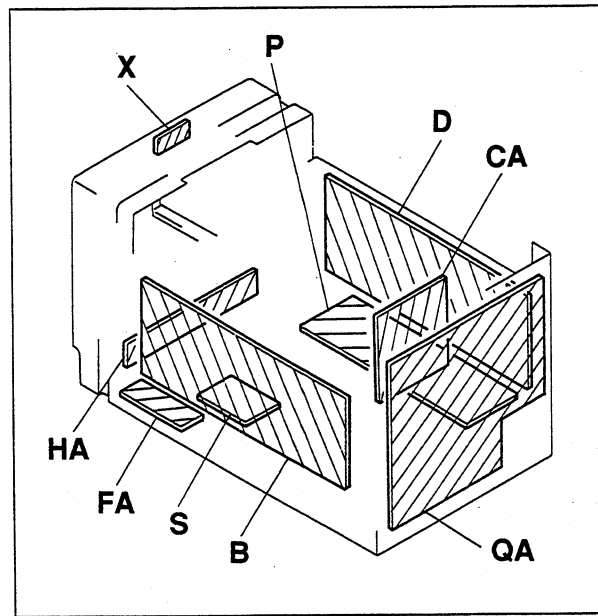

6-5. PRINTED WIRING BOARDS AND SCHEMATIC DIAGRAMS

Note:

- All capacitors are in μF unless otherwise noted. pF: μF 50WV or less are not indicated except for electrolytics.
- Indication of resistance, which does not have one for rating electrical power, is as follows.

Pitch: 5 mm
Rating electrical power 1/4W

- All resistors are in ohms.
- : nonflammable resistor.
- : fusible resistor.
- : internal component.
- : panel designation.
- All variable and adjustable resistors have characteristic curve B, unless otherwise noted.
- The components identified by in this basic schematic diagram have been carefully factory-selected for each set in order to satisfy regulations regarding X-ray radiation. Should replacement be required, replace only with the value originally used.
- When replacing components identified by , make the necessary adjustments indicated. If results do not meet the specified value, change the component identified by and repeat the adjustment until the specified value is achieved. (Refer to RV651, RV1603, and RV833 adjust on page 18 and 19.)
- When replacing the part in below table be sure to perform the related adjustment.

Part replaced (▣)	Adjustment (⊠)
IC601, IC651, PH601, C654, R653, R655, R656, R657, RV651	RV651 (B+ MAX)
Q1601, Q1602, Q1603, D1601, D1602, D1603, D1604, D1605, C1601, C1602, R1601, R1602, R1603, R1604, R1605, R1606, R1607, R1608, R1628, R1629, R1630, RV1601, RV1603	RV1603 (B+MAX IN DC POWER INPUT MODE)
IC502, Q833, Q834, Q835, Q836, D835, D836, C519, C814, C843, C844, C845, C846, C847, C848, RV833, R523, R850, R851, R852, R853, R854, R855, R856, R857, R858, R859, R861, R862, R863, NL801	RV833 (HOLD-DOWN)

- All voltages are in V.
- Voltage are dc with respect to ground unless otherwise noted.
- Readings are taken with a color-bar signal input.
- Readings are taken with a PAL color-bar signal input.
- : adjustment for repair.
- Voltage variations may be noted due to normal production tolerance.
- : B+ bus.
- : B- bus.
- : signal path.
- No mark: with PAL color-bar signal received or common voltage.
- () : with SECAM color-bar signal received.
- < > : with NTSC 3.58 color-bar signal received.
- (()) : with NTSC 4.43 color-bar signal received.
- [] : with S (Y/C) color-bar signal received.
- { } : with analog RGB color-bar signal received.
- << >> : with component color-bar signal received.
- ※ : measurement impossibility.

Reference information

RESISTOR	: RN	METAL FILM
	: RC	SOLID
	: FPRD	NONFLAMMABLE CARBON
	: FUSE	NONFLAMMABLE FUSIBLE
	: RS	NONFLAMMABLE WIREWOUND
	: RB	NONFLAMMABLE CEMENT
COIL	: LF-8L	MICRO INDUCTOR
CAPACITOR	: TA	TANTALUM
	: PS	STYROL
	: PP	POLYPROPYLENE
	: PT	MYLAR
	: MPS	METALIZED POLYESTER
	: MPP	METALIZED POLYPROPYLENE
	: ALB	BIPOLAR
	: ALT	HIGH TEMPERATURE
	: ALR	HIGH RIPPLE

P [H OUT, FBT]

G [SWITCHING REGULATOR]

— P Board —

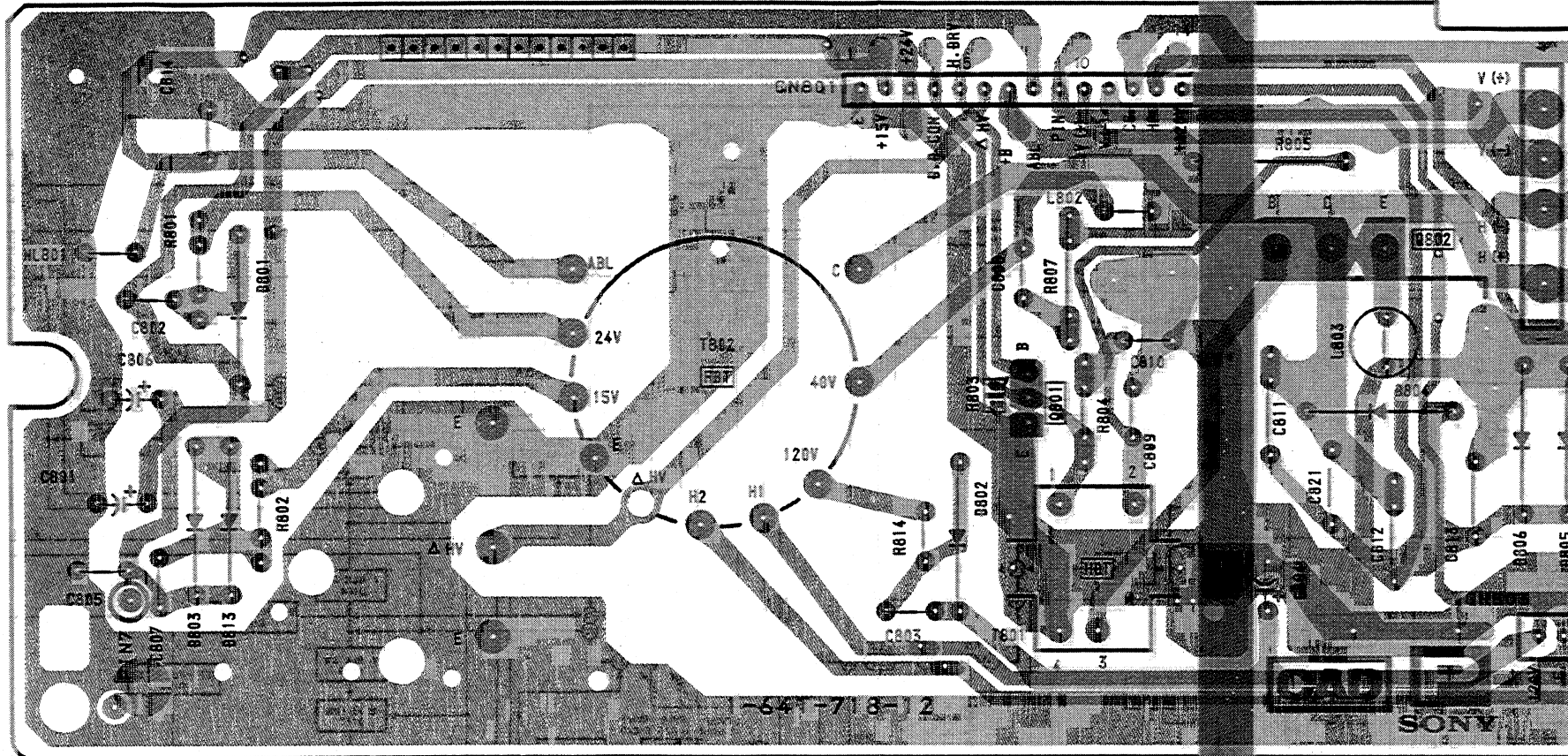

— G Board —

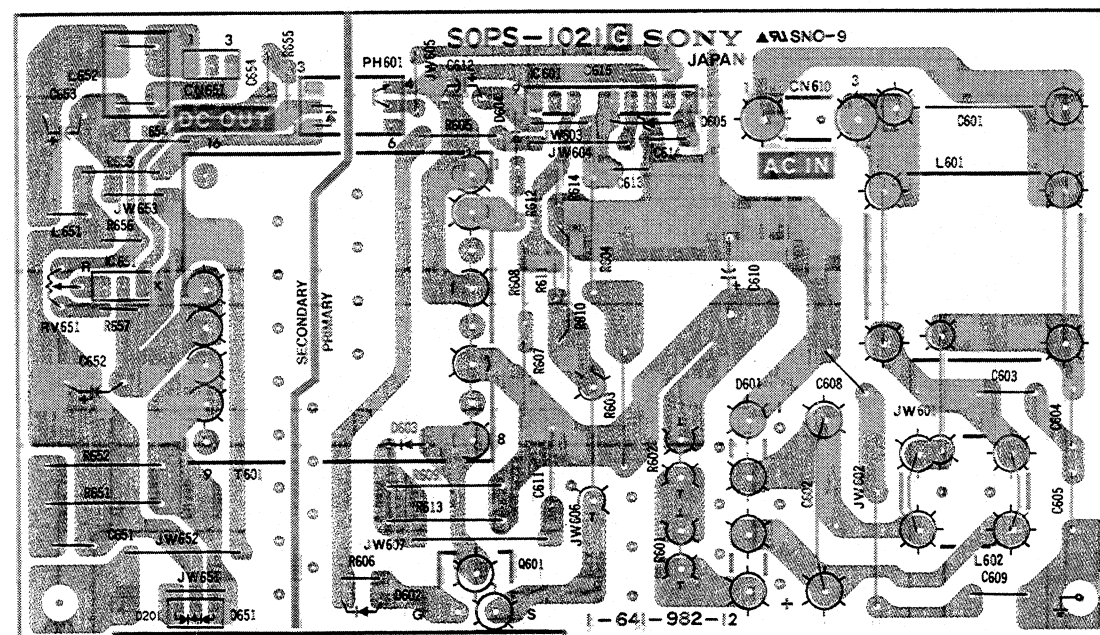

— X Board —

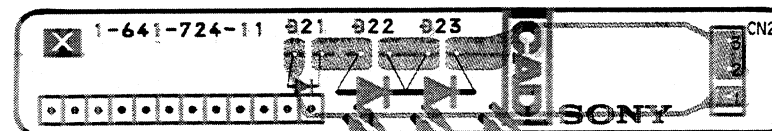

— S Board — — Component side —

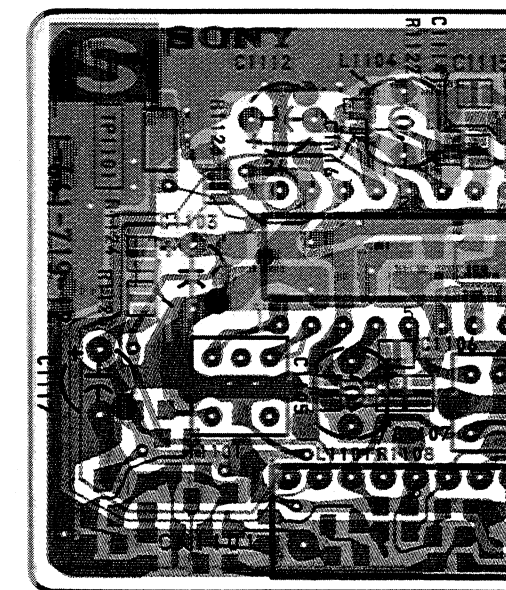

- : Pattern from the side which enables see
- : Pattern of the rear side.

X

[TALLY LAMP]

S

[SECAM DEMODULATION]

FA

[AC/DC]

QA

[INPUT SIGNAL SELECTOR]

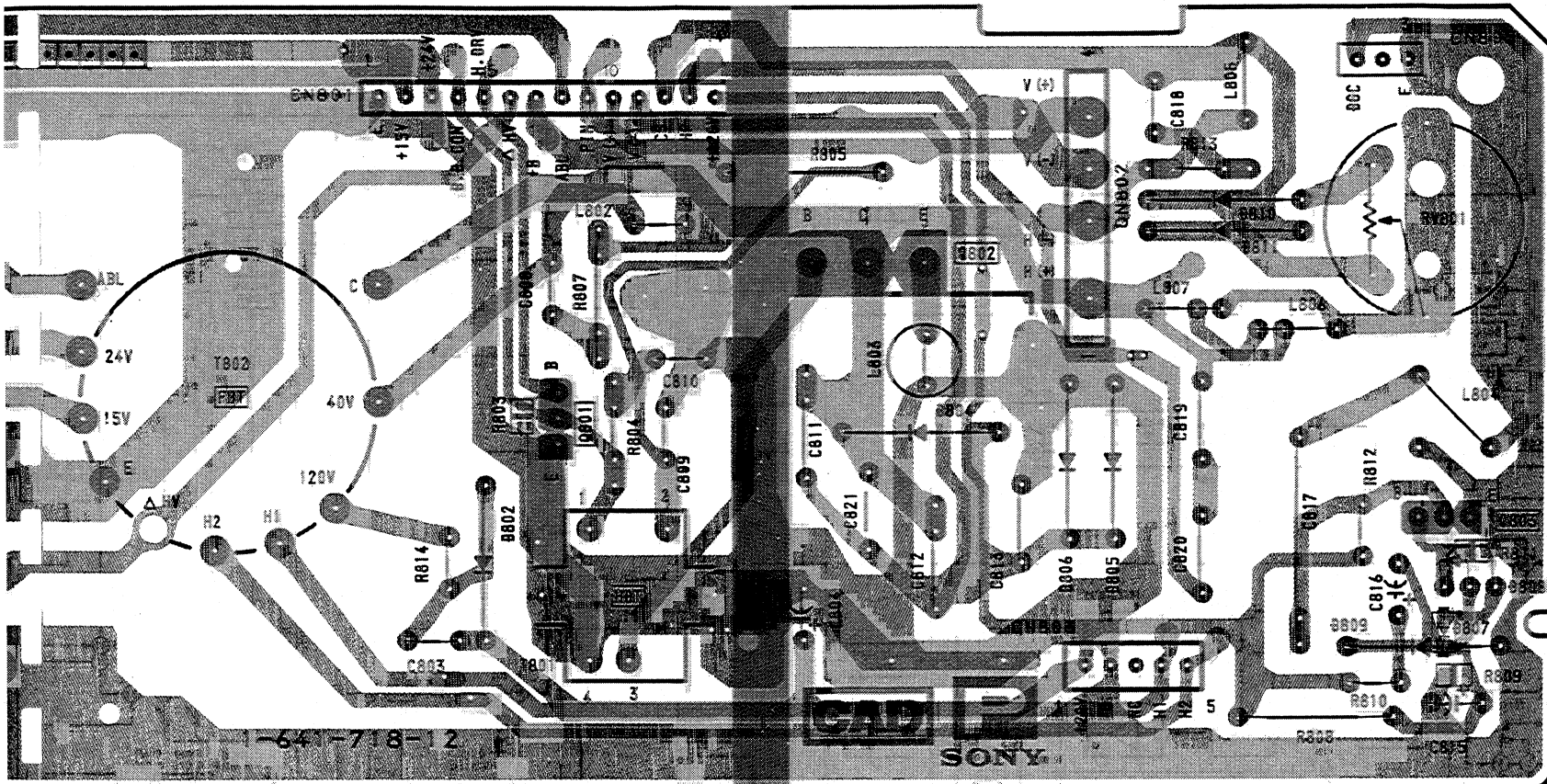

— FA Board —

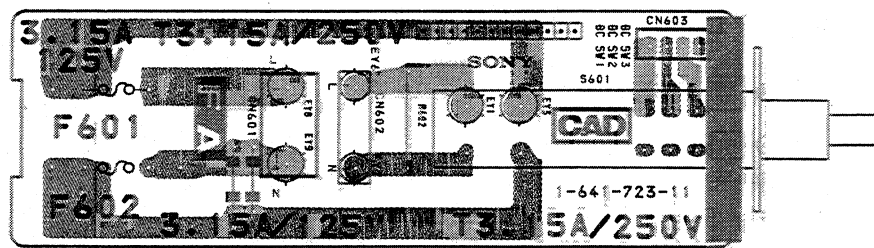

— S Board — — Conductor side —

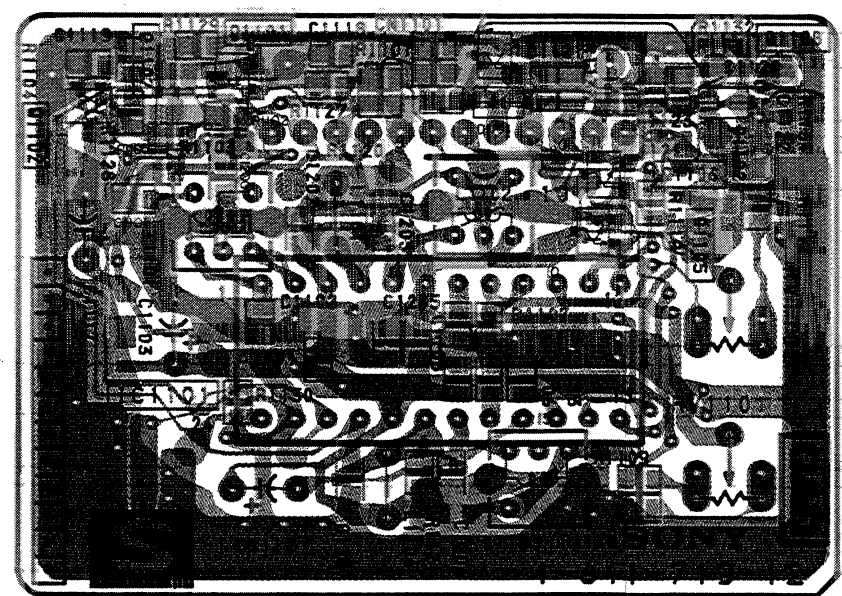

• : Pattern from the side which enables seeing.
 • : Pattern of the rear side.

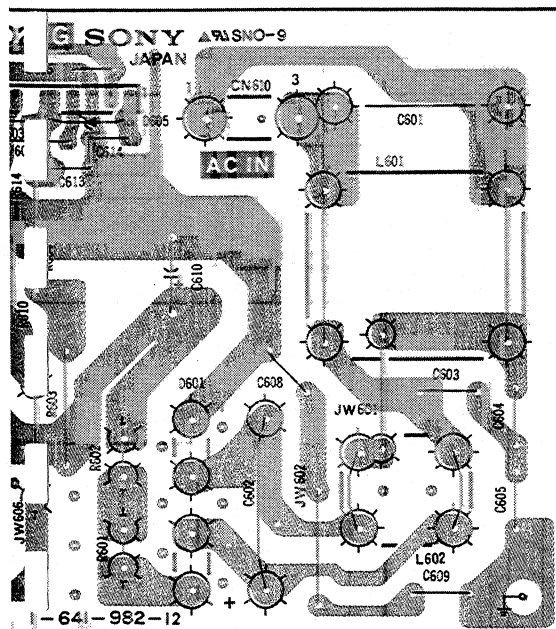

— S Board — — Component side —

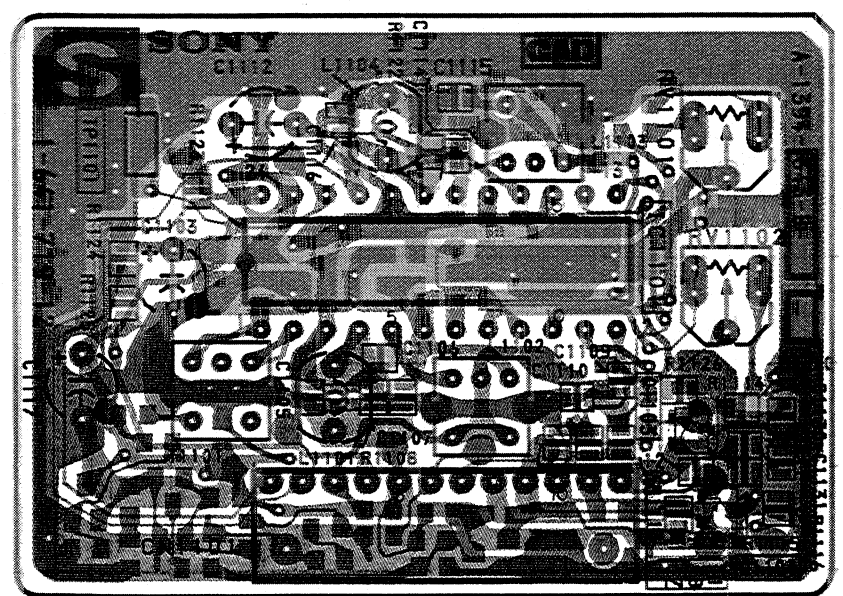

• : Pattern from the side which enables seeing.
 • : Pattern of the rear side.

QA Board

IC	D404	C-8	
	D405	C-8	
	D406	C-6	
IC401	B-4	D407	C-6
IC402	D-4	D408	C-9
IC403	H-4	D409	C-9
TRANSISTOR			
Q401	C-8	D410	D-1
Q402	C-6	D411	D-2
Q403	C-4	D412	C-1
Q404	B-9	D413	C-2
Q405	B-10	D414	C-11
Q406	E-9	D415	C-11
Q407	E-7	D416	E-9
Q408	B-10	D417	E-9
Q409	E-5	D418	E-8
Q410	E-3	D419	E-8
Q411	D-2	D420	F-5
Q412	C-7	D421	E-5
Q413	C-4	D422	E-3
Q414	E-4	D423	E-4
Q416	G-3	D424	B-2
Q417	D-1	D425	B-1
Q418	C-1	D426	B-2
Q419	B-2	D427	B-2
Q420	B-2	D428	C-1
Q421	B-2	D429	C-1
Q422	B-2	D430	B-2
Q423	C-1	D431	B-2
Q424	B-3		
DIODE			
D401	D-2		
D402	D-3		
D403	F-3		
VARIABLE RESISTOR			
RV401	F-7		

— QA Board —

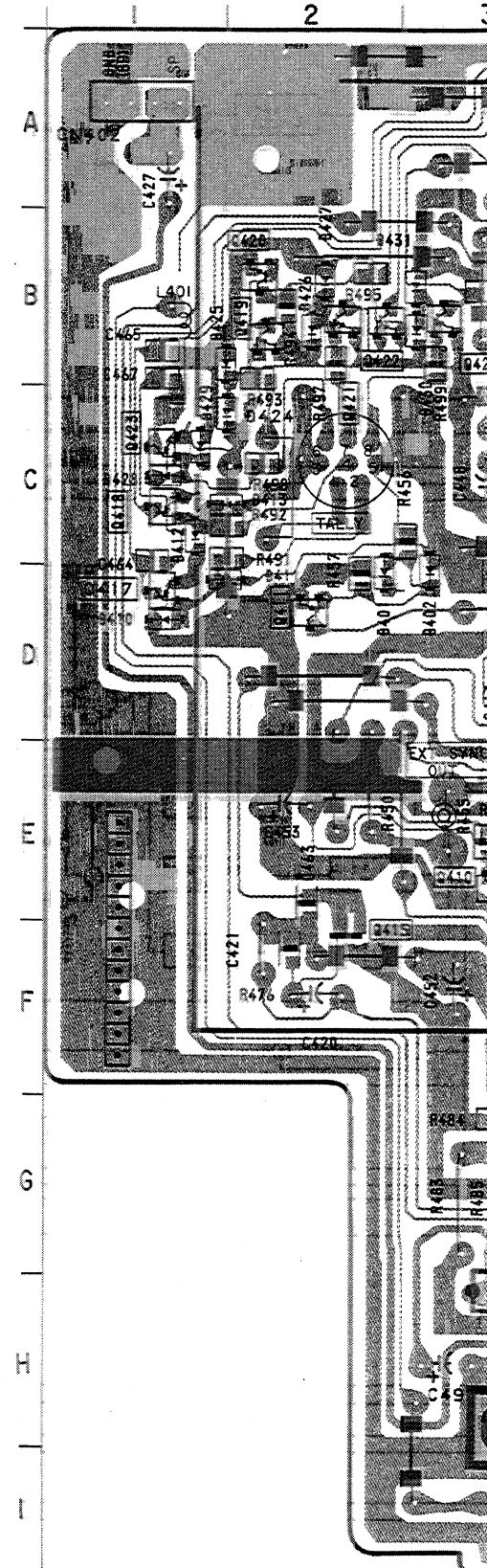



[AC/DC]

QA Board

IC	D404	C-8	
	D405	C-8	
	D406	C-6	
IC401	B-4	D407	C-6
IC402	D-4	D408	C-9
IC403	H-4	D409	C-9
	D410	D-1	
	D411	D-2	
TRANSISTOR	D412	C-1	
	D413	C-2	
Q401	C-8	D414	C-11
Q402	C-6	D415	C-11
Q403	C-4	D416	E-9
Q404	B-9	D417	E-9
Q405	B-10	D418	E-8
Q406	E-9	D419	E-8
Q407	E-7	D420	F-5
Q408	B-10	D421	E-5
Q409	E-5	D422	E-3
Q410	E-3	D423	E-4
Q411	D-2	D424	B-2
Q412	C-7	D425	B-1
Q413	C-4	D426	B-2
Q414	E-4	D427	B-2
Q416	G-3	D428	C-1
Q417	D-1	D429	C-1
Q418	C-1	D430	B-2
Q419	B-2	D431	B-2
Q420	B-2		
Q421	B-2		
Q422	B-2		
Q423	C-1		
Q424	B-3		
	VARIABLE RESISTOR		
	RV401	F-7	
DIODE			
D401	D-2		
D402	D-3		
D403	F-3		



[INPUT SIGNAL SELECTOR]

— QA Board —

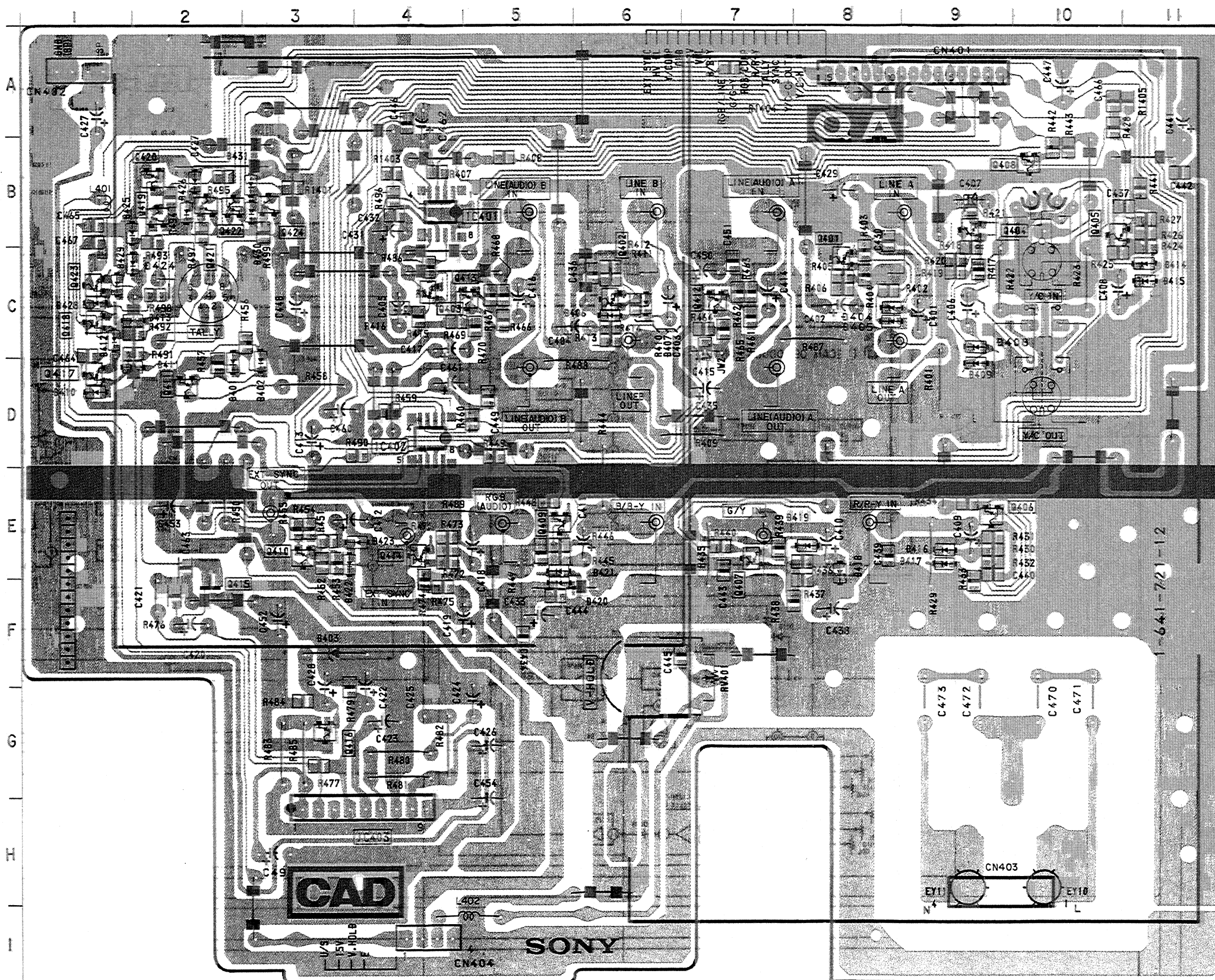

— A Board —

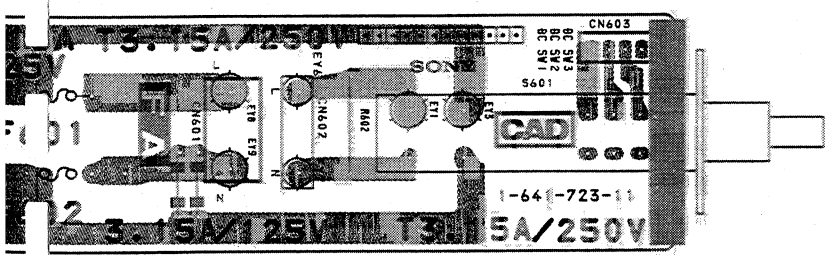

— B Board — Conductor side —

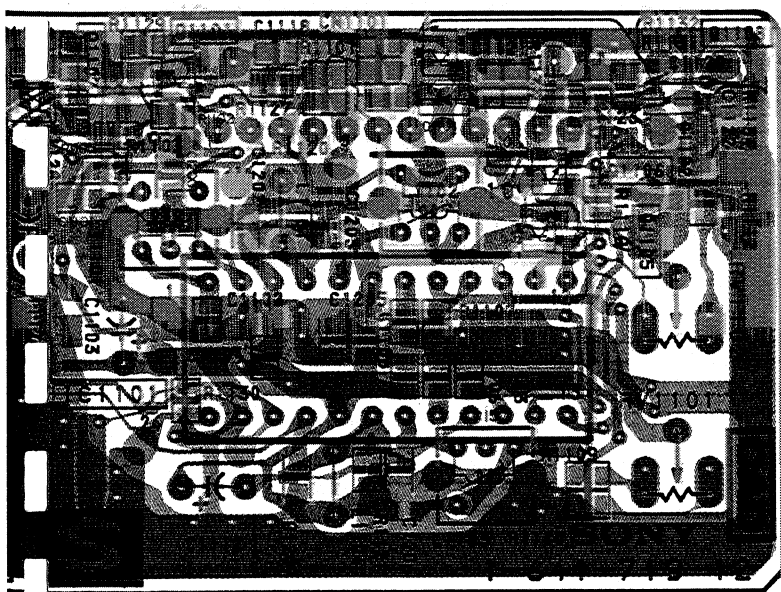

- : Pattern from the side which enables seeing.
- : Pattern of the rear side.

S BOARD IC1101 CXA1214P

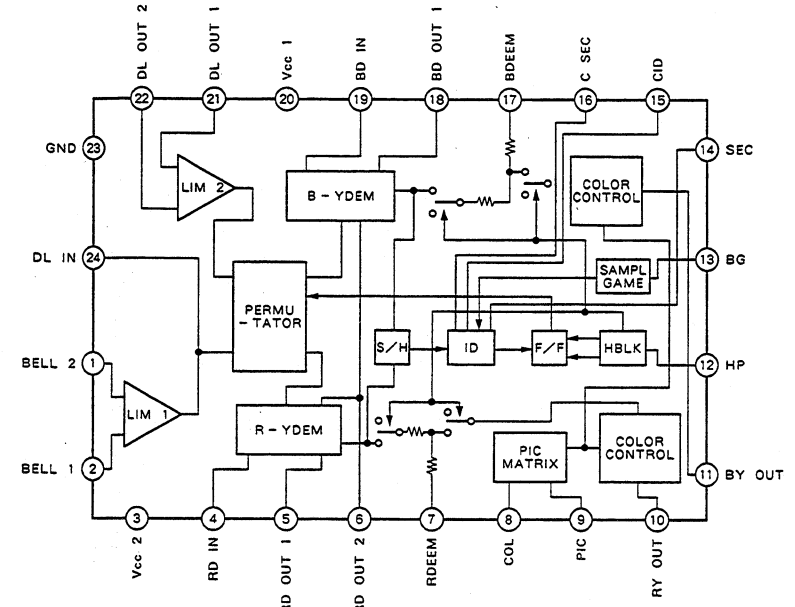

QA BOARD IC403 AN5265

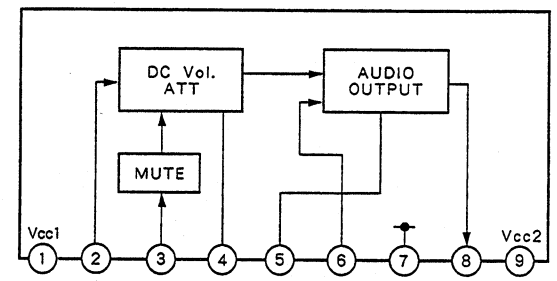

P BOARD WAVEFORMS

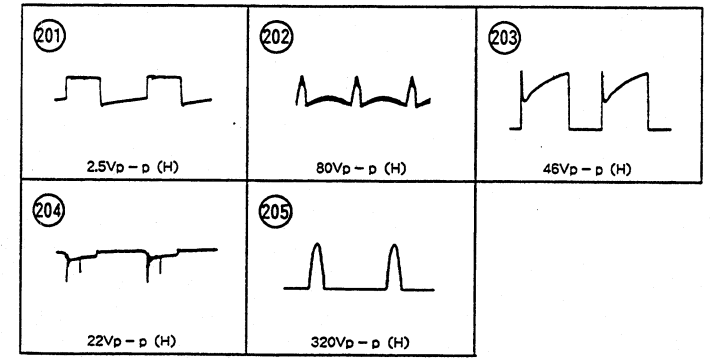

S BOARD WAVEFORMS

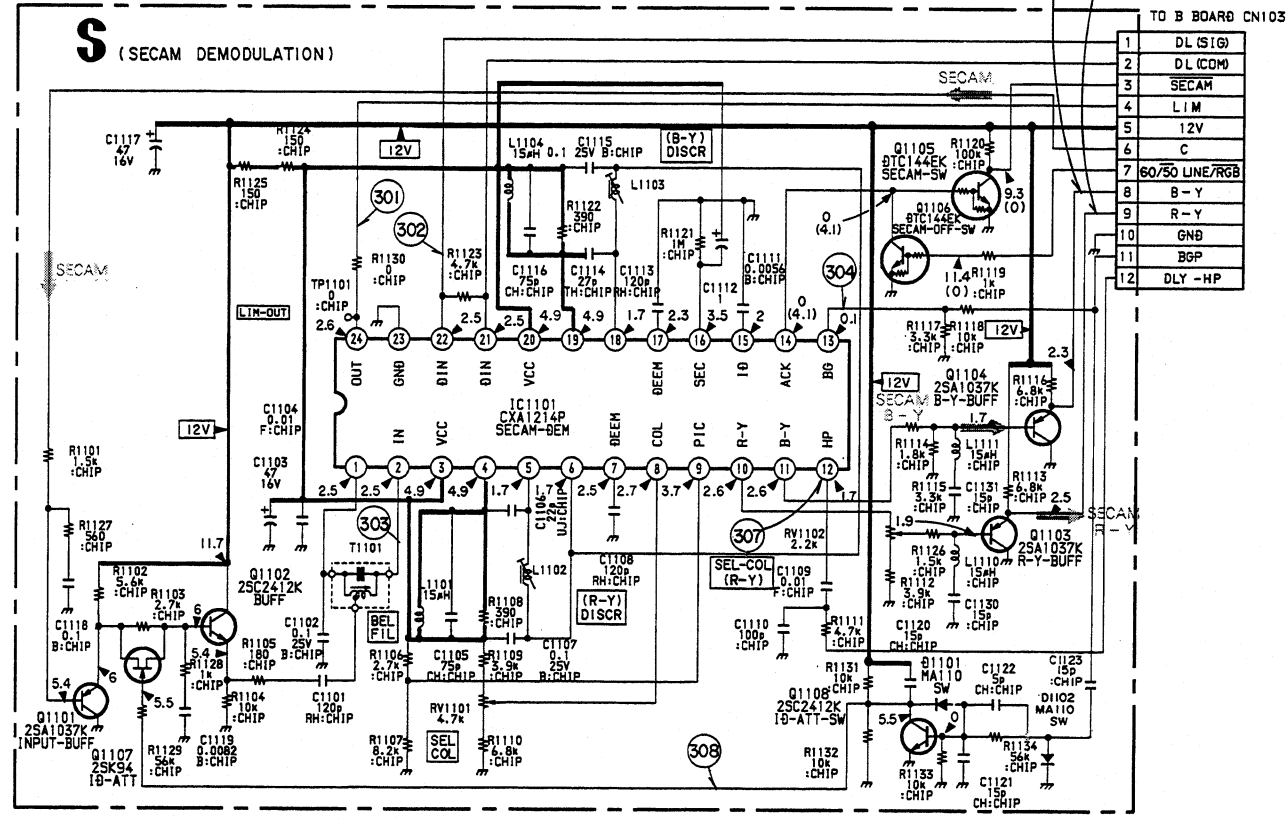
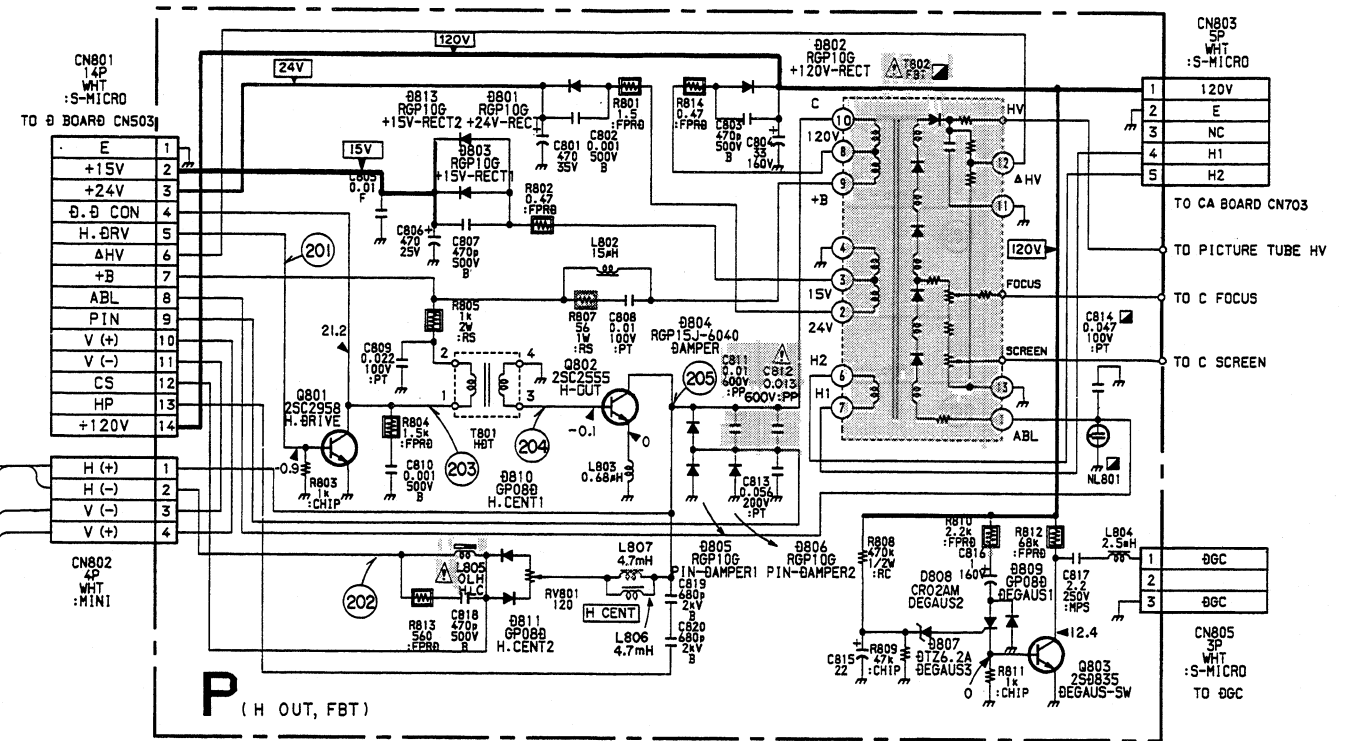
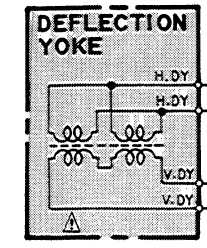
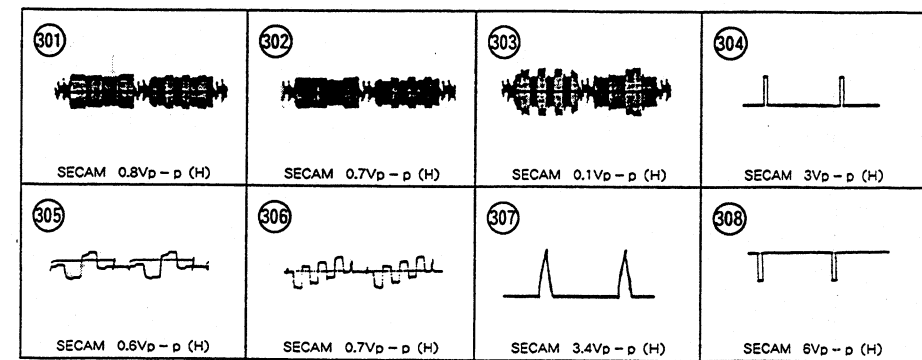

31: See Page 18, 19

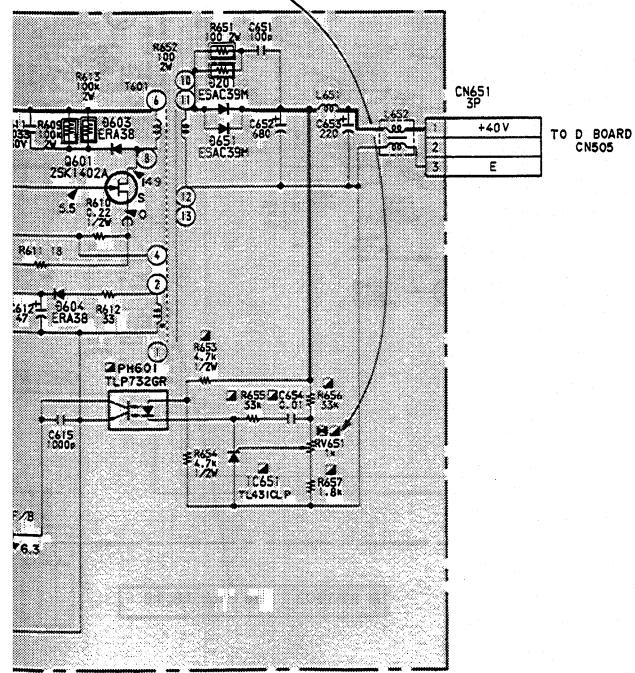

1 2 3 4 5 6 7 8 9 10 11 12 13 14 15 16

A B C D E F G H I J

D BOARD WAVEFORMS

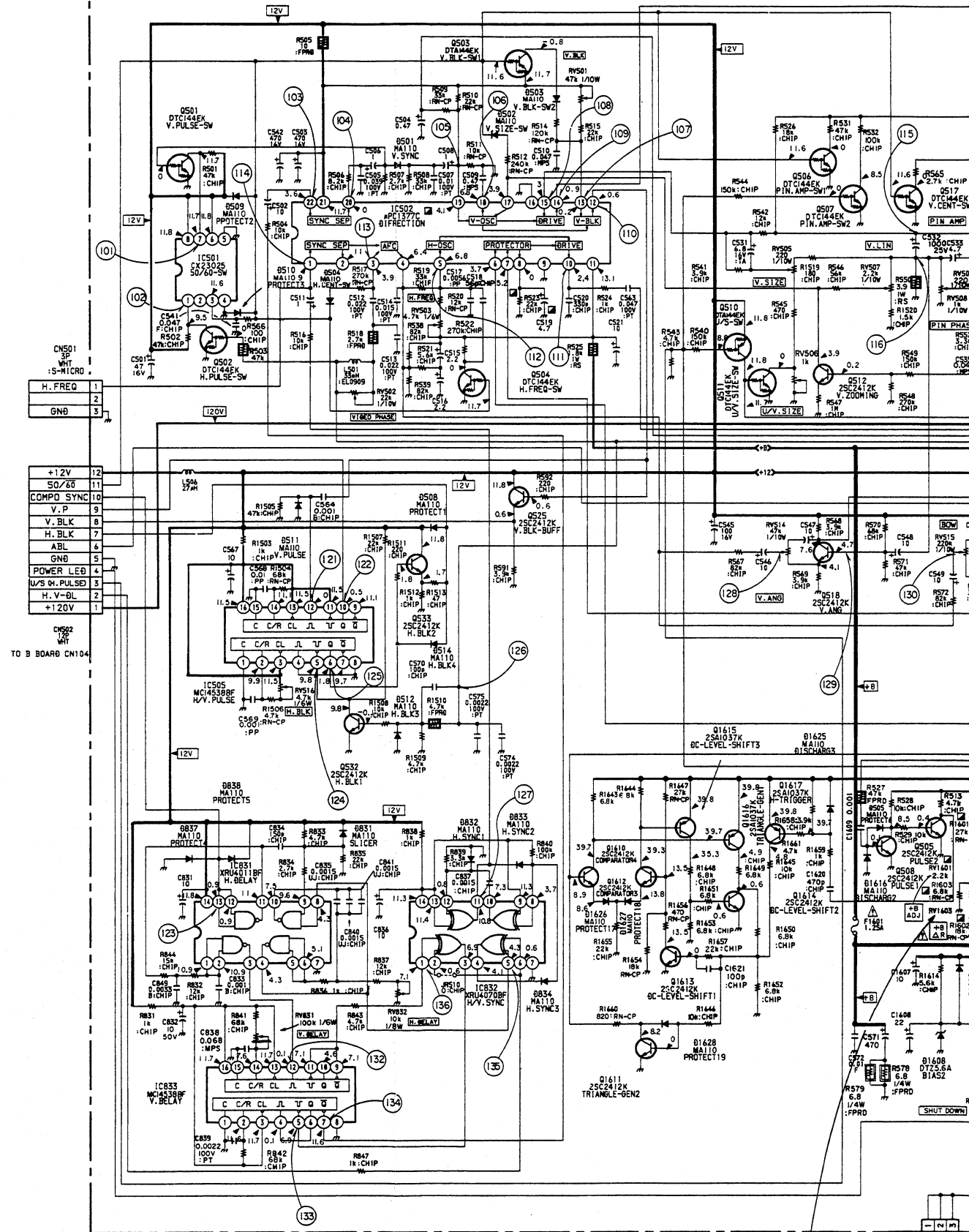
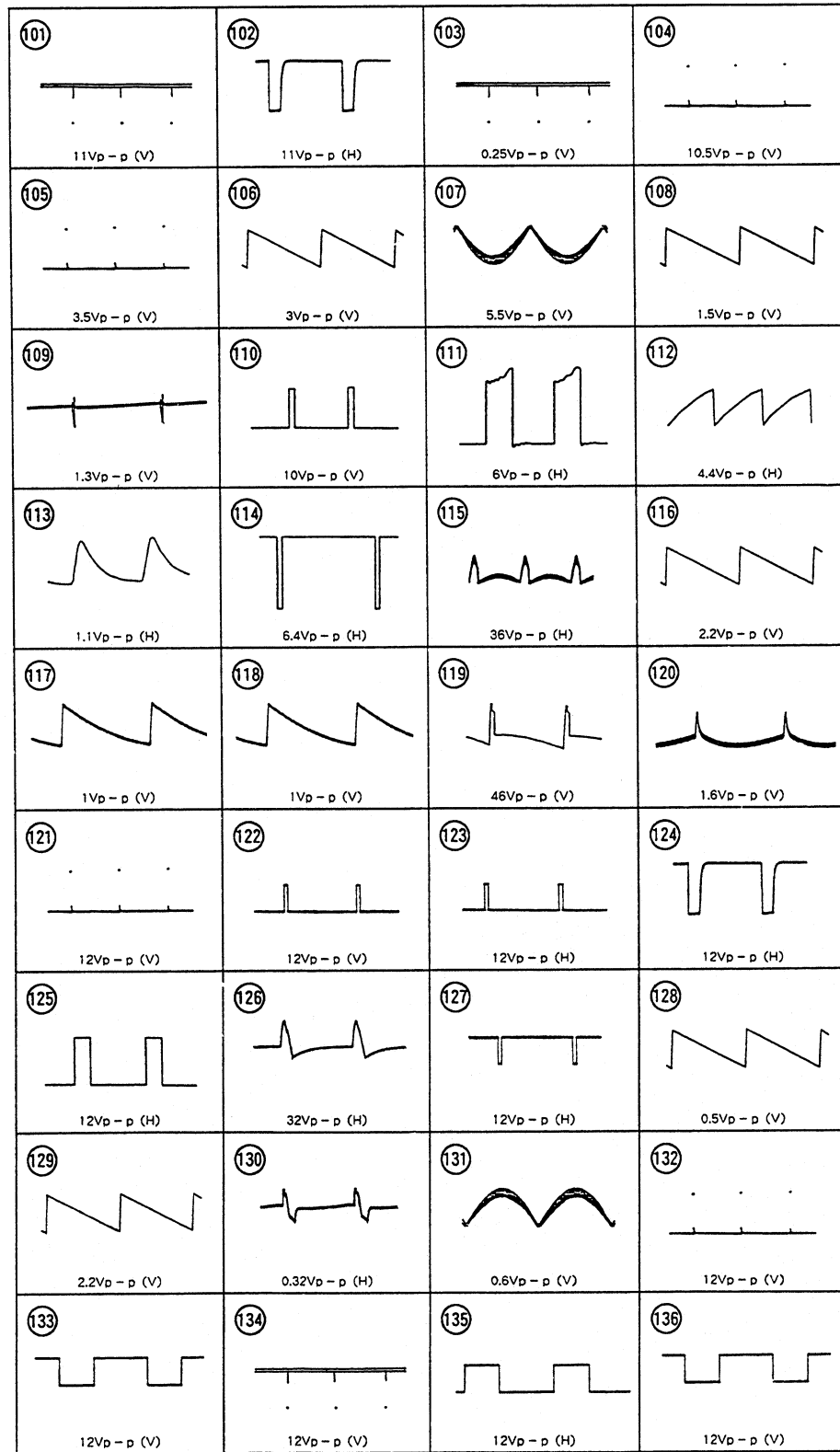

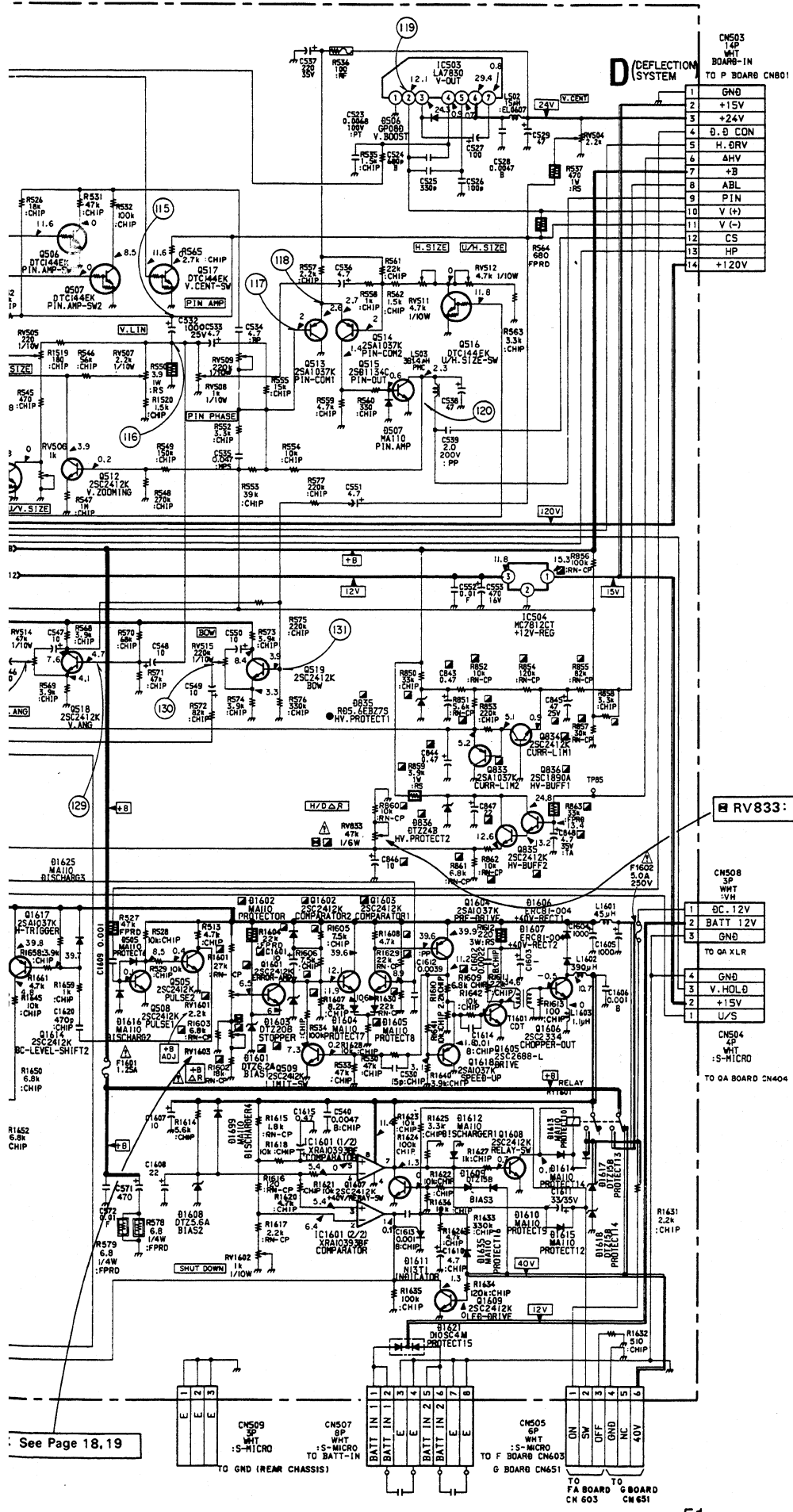

D BOARD IC501 CX23025

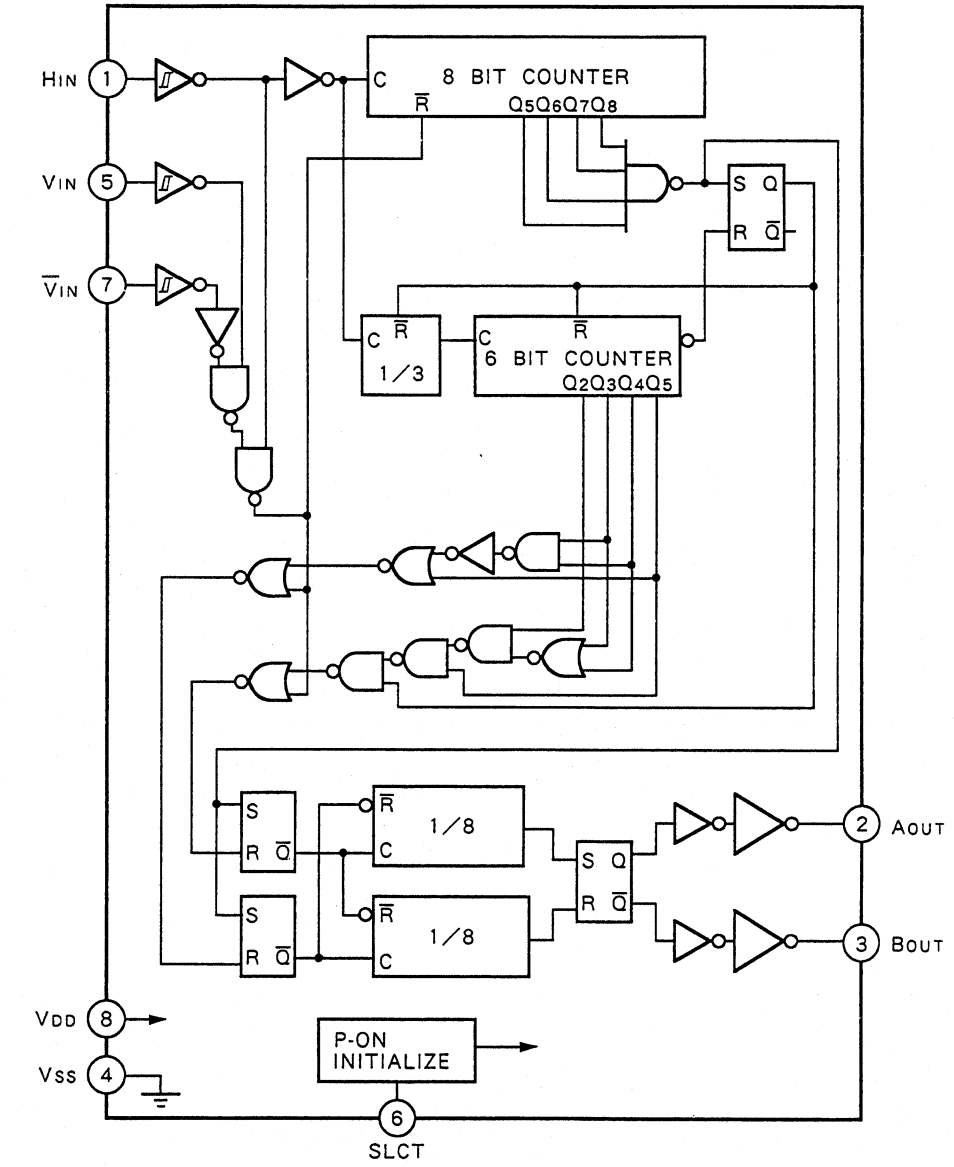

D BOARD IC503 LA7830

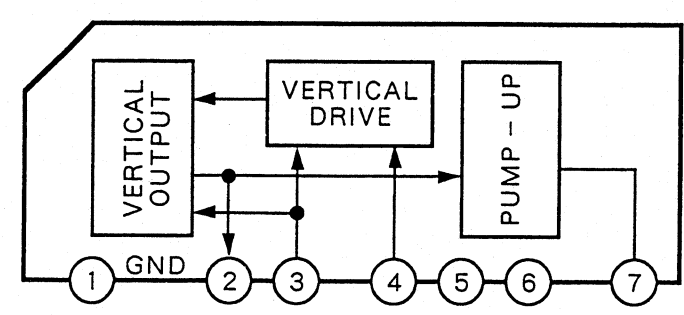

D [DEFLECTION SYSTEM]

— D Board — — Component side —

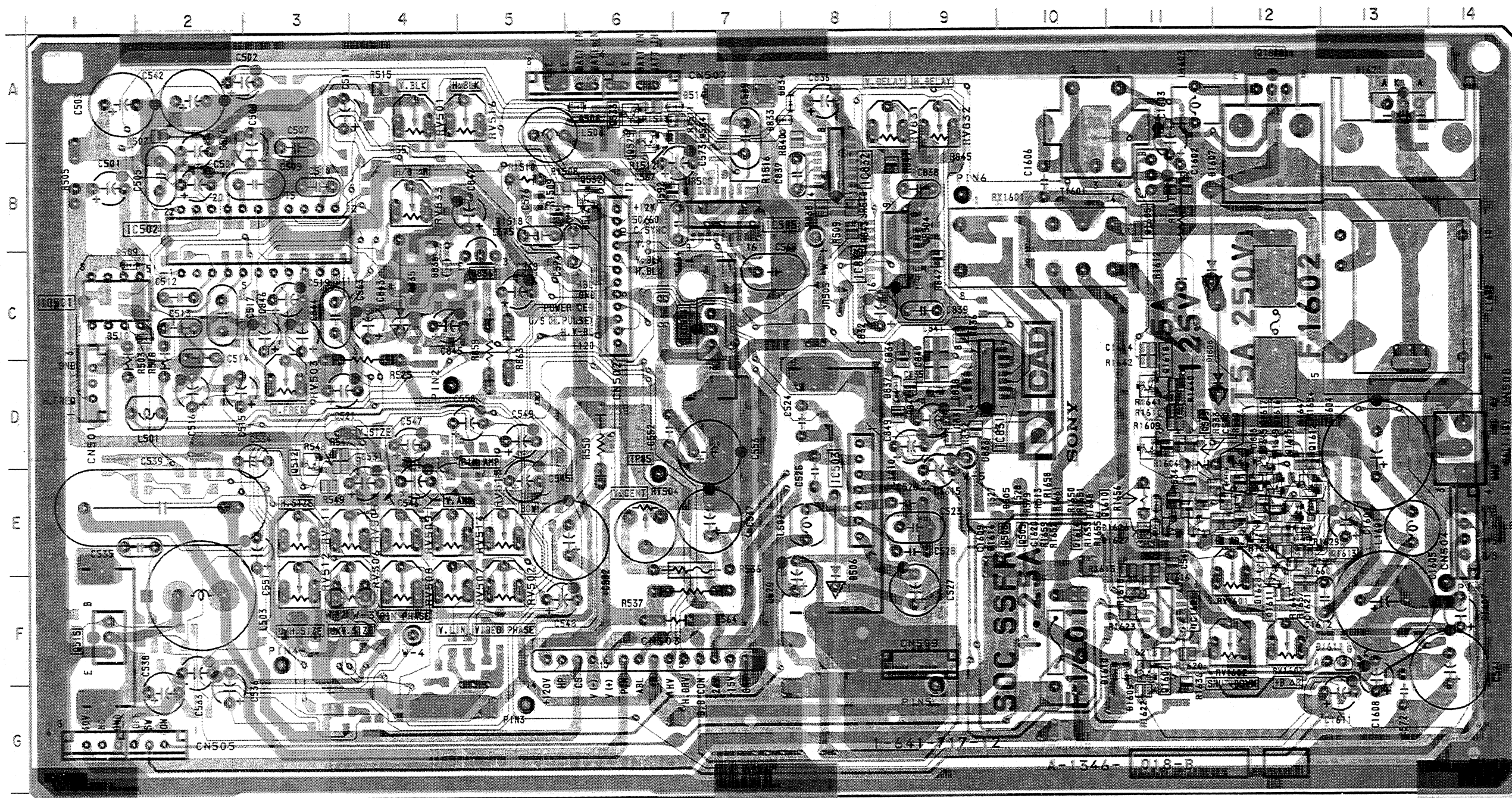

D Board (Component S

IC	DIOI
IC501	C-1
IC505	B-7
IC831	D-9
IC832	B-8
IC833	C-8
IC1601	F-11
TRANSISTOR	
Q505	E-11
Q508	E-11
Q509	D-11
Q512	D-3
Q525	A-6
Q532	B-6
Q533	A-6
Q1607	F-11
Q1610	E-12
Q1611	F-12
Q1612	D-12
Q1613	E-13
Q1614	E-12
Q1615	D-12
Q1616	D-12
Q1617	D-12
Q1618	D-11
D505	
D508	
D509	
D510	
D512	
D514	
D833	
D834	
D836	
D837	
D838	
D1609	
D1610	
D1616	
D1621	
D1625	
D1626	
D1627	
D1628	

• [Hatched Pattern] : Pattern from the side which enables seeing.
 • [Solid Pattern] : Pattern of the rear side.

D Board (Component Side)

IC		DIODE	
IC501	C-1	D505	E-11
IC505	B-7	D508	A-6
IC831	D-9	D509	C-1
IC832	B-8	D510	C-2
IC833	C-8	D512	B-6
IC1601	F-11	D514	A-7
TRANSISTOR		D833	A-7
Q505	E-11	D834	A-8
Q508	E-11	D836	C-4
Q509	D-11	D837	D-9
Q512	D-3	D1609	F-11
Q525	A-6	D1610	F-11
Q532	B-6	D1616	E-11
Q533	A-6	D1621	A-13
Q1607	F-11	D1625	D-12
Q1610	E-12	D1626	E-12
Q1611	F-12	D1627	E-12
Q1612	D-12	D1628	E-12
Q1613	E-13		
Q1614	E-12		
Q1615	D-12		
Q1616	D-12		
Q1617	D-12		
Q1618	D-11		

— D Board — — Conductor side —

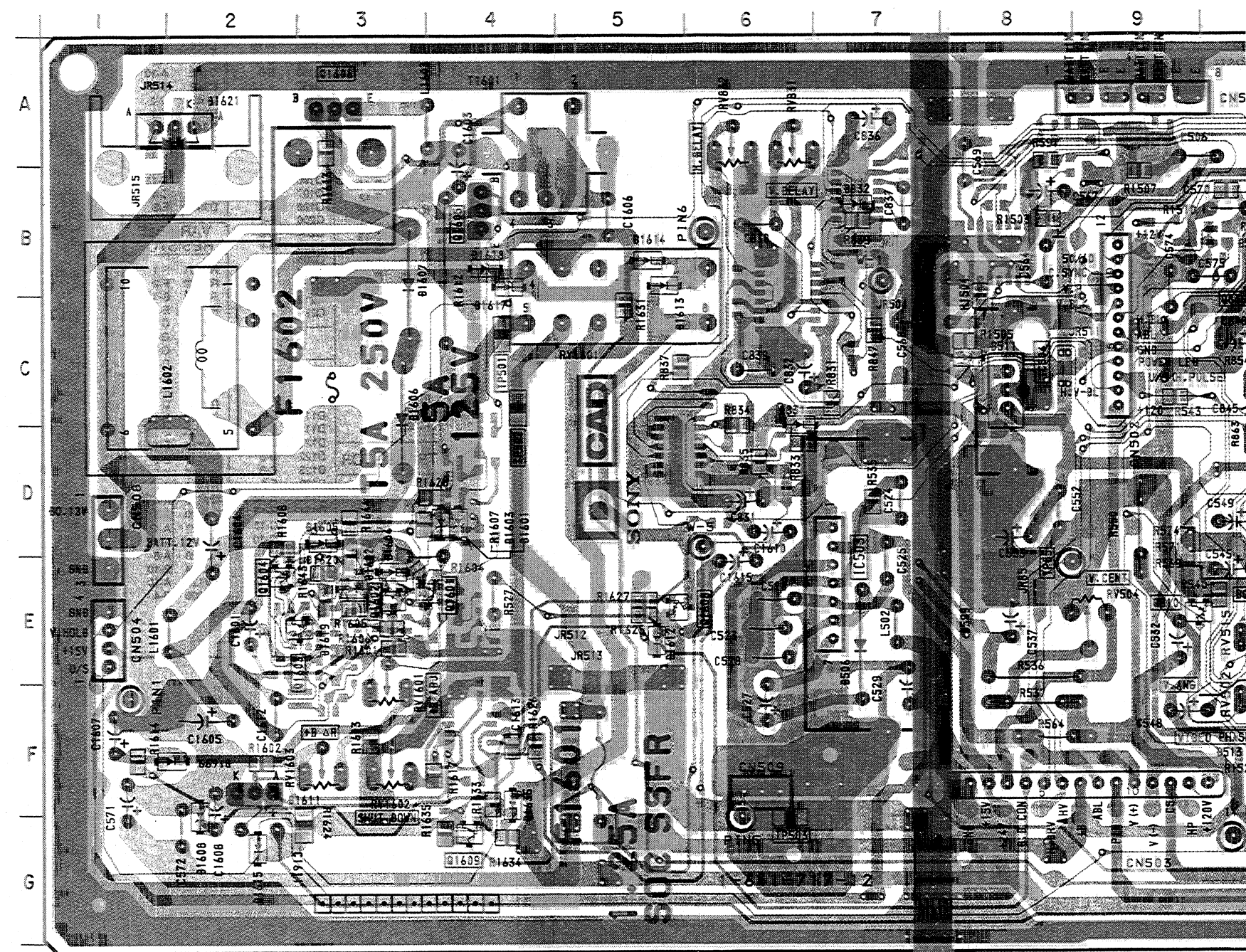

- [Pattern from the side which enables seeing.]
- [Pattern of the rear side.]

ductor side —

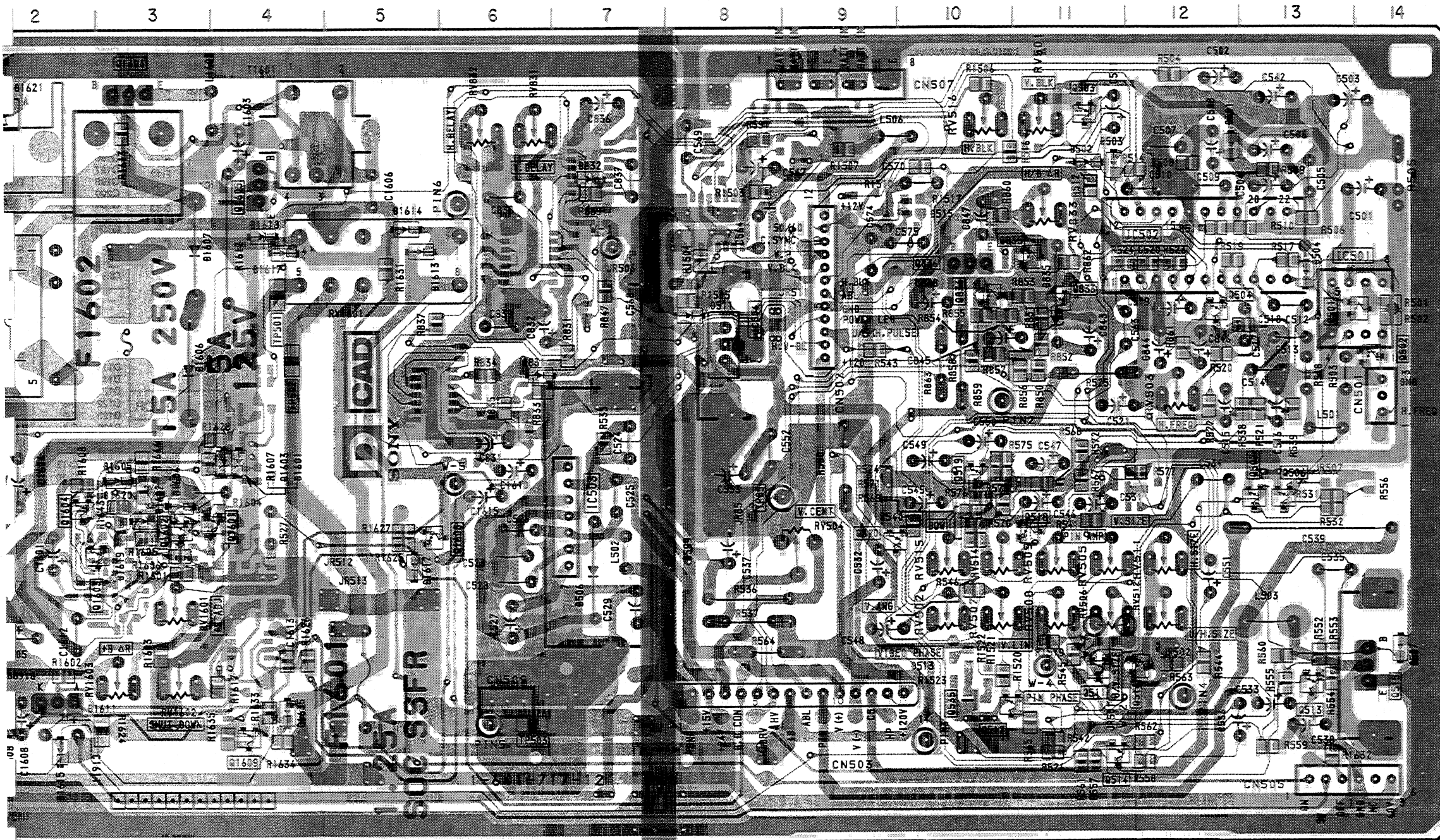

D Board (Conductor Side)

IC		DIODE		FUSE
IC502	B-12	D501	A-12	F1601 F-5
IC503	E-7	D502	B-11	VARIABLE RESISTOR
IC504	C-8	D503	B-11	
		D504	C-13	
		D506	E-7	
TRANSISTOR		D507	F-14	RV501 A-11
Q501	C-14	D511	C-8	RV502 F-10
Q502	C-14	D599	E-8	RV503 D-12
Q503	A-11	D831	C-6	RV504 E-9
Q504	C-12	D832	B-7	RV505 E-11
Q506	E-13	D835	C-11	RV506 F-11
Q507	E-13	D1601	D-4	RV507 F-10
Q510	E-9	D1602	D-3	RV508 F-11
Q511	F-11	D1603	D-4	RV509 F-11
Q513	F-13	D1604	D-3	RV511 E-12
Q514	G-11	D1605	D-3	RV512 F-11
Q515	F-14	D1606	C-3	RV514 E-10
Q516	F-12	D1607	B-3	RV515 E-10
Q517	F-10	D1608	G-2	RV516 A-10
Q518	E-11	D1611	F-2	RV831 A-6
Q519	D-10	D1612	E-5	RV832 A-6
Q833	C-11	D1613	B-5	RV833 B-11
Q834	C-10	D1614	B-5	RV1601 F-3
Q835	B-11	D1615	G-2	RV1602 F-3
Q836	C-10	D1617	B-4	RV1603 F-3
Q1601	E-3	D1618	B-4	
Q1602	E-3	D1619	D-3	
Q1603	E-2	D1621	A-2	
Q1604	E-2	D1635	F-4	
Q1605	B-4	D1699	F-2	
Q1606	A-3			
Q1608	E-5			
Q1609	G-4			

- [Pattern] : Pattern from the side which enables seeing.
- [Pattern] : Pattern of the rear side.

Conductor side —

2 3 4 5 6 7 8 9 10 11 12 13 14

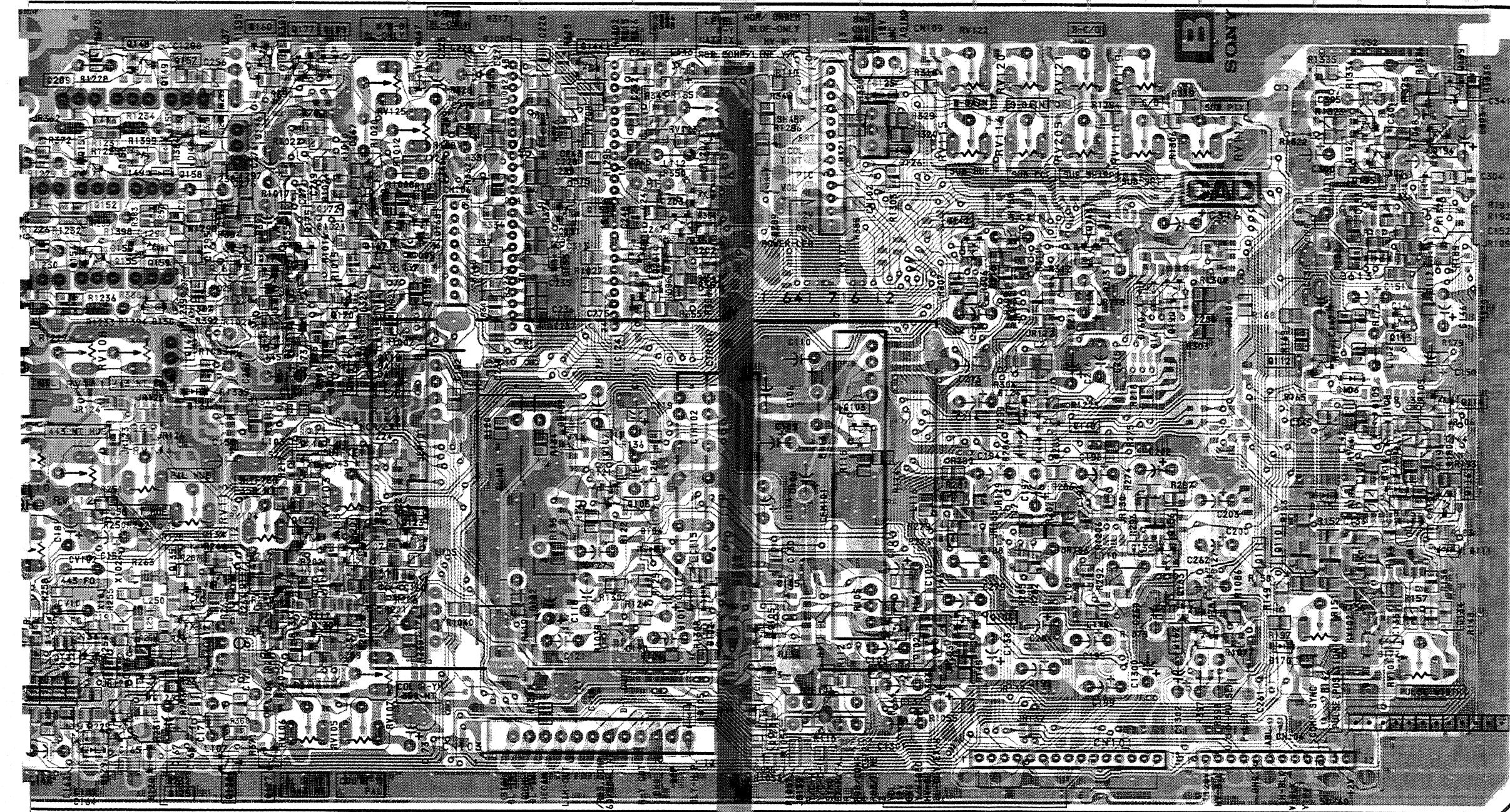

B Board (Conductor Side)

TRANSISTOR			
Q102	F-9	Q158	B-3
Q103	D-8	Q159	C-2
Q105	F-8	Q160	A-3
Q106	F-9	Q161	C-3
Q107	D-6	Q162	F-12
Q108	E-6	Q163	F-11
Q112	D-13	Q165	D-4
Q114	D-14	Q166	C-4
Q116	E-14	Q167	B-5
Q117	F-3	Q170	C-4
Q118	E-4	Q172	B-4
Q120	E-4	Q173	C-4
Q122	E-4	Q174	C-3
Q123	E-5	Q175	C-4
Q125	G-2	Q177	A-4
Q126	G-2	Q178	G-8
Q127	G-3	Q179	A-4
Q128	G-3	Q190	C-11
Q130	F-4	Q192	B-13
Q131	F-2	Q194	B-14
Q133	F-2	Q195	B-13
Q134	E-3	Q199	A-14
Q135	F-3	Q201	C-7
Q139	E-11	Q202	B-7
Q140	D-10	Q203	B-7
Q142	C-9	Q209	A-2
Q143	C-10	Q210	B-1
Q144	A-6	Q211	C-1
Q146	B-3		
Q147	D-2	DIODE	
Q148	A-2	D101	F-7
Q151	B-2	D102	F-7
Q152	B-2	D104	E-7
Q154	C-2	D105	G-7
Q155	C-2	D106	D-13
		D108	D-13
		D109	D-13
		D110	E-13
		D111	E-14
		D112	C-14
		D113	C-13
		D115	E-13
		D116	D-13
		D117	D-13
		D120	G-2
		D124	D-10
		D125	A-9
		D126	B-9
		D127	F-12
		D129	G-2
		D133	B-6
		D134	B-6
		D135	C-6
		D136	D-3
		D144	D-3
		D145	D-3
		D147	A-5
		D148	B-3
		D149	B-2
		D150	C-2
		D155	B-2
		D158	B-2
		D159	C-2
		D160	C-11
		D161	C-11
		D170	F-12
		D171	F-13
		D172	F-13
		D284	D-10
		D285	D-10
		D289	B-8
		D341	B-13

- : Pattern from the side which enables seeing.
- : Pattern of the rear side.

HA

[USER CONTROL, WHITE BALANSE]

CA

[CRT SOCKET]

— HA Board —

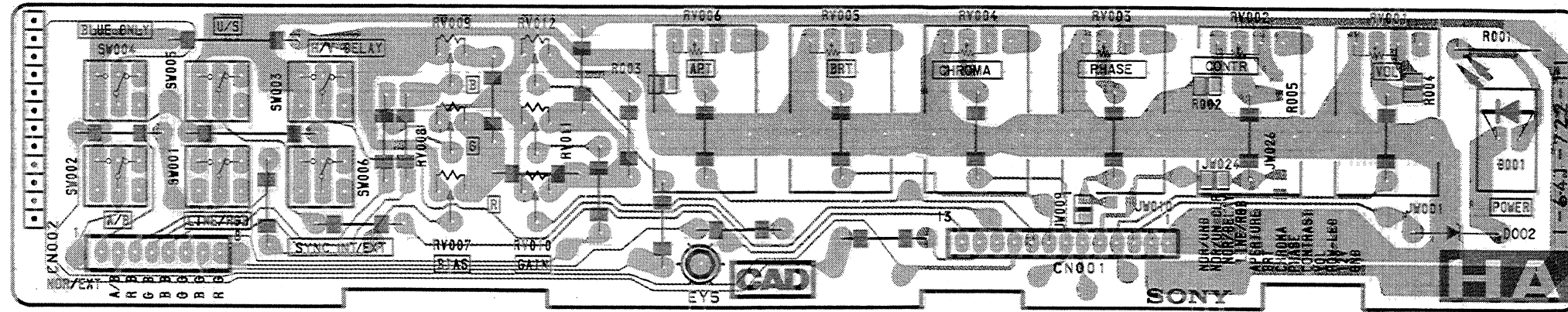

— CA Board —

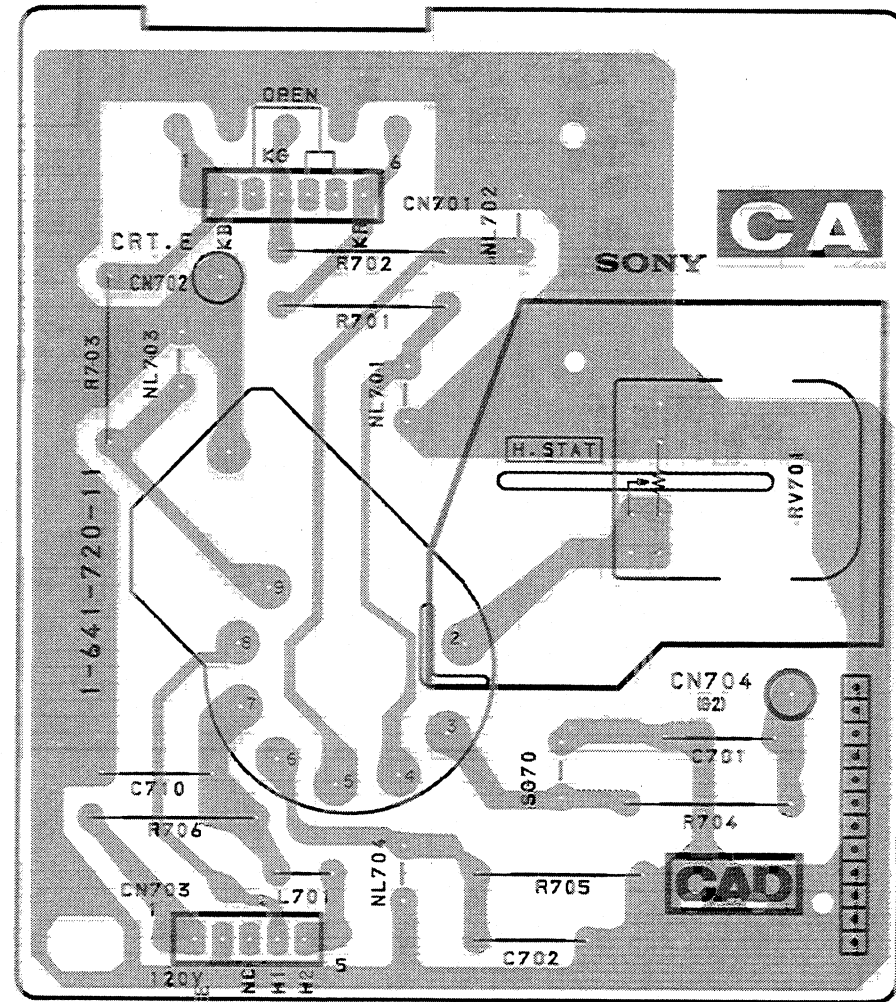

B BOARD WAVEF

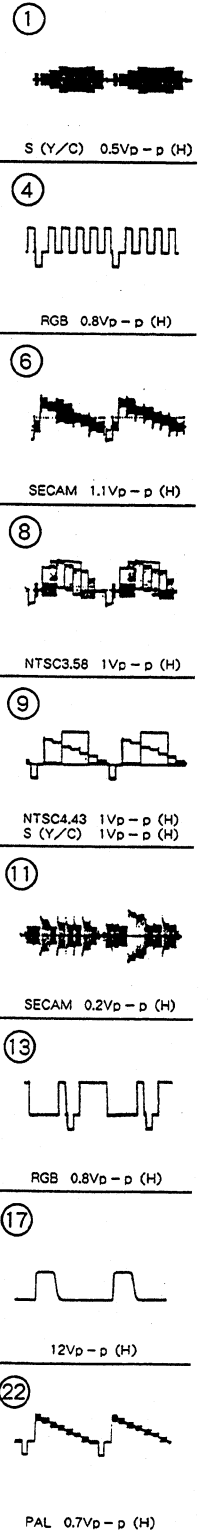

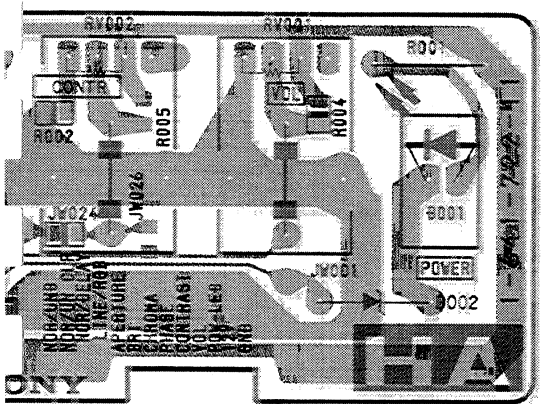

B BOARD WAVEFORMS

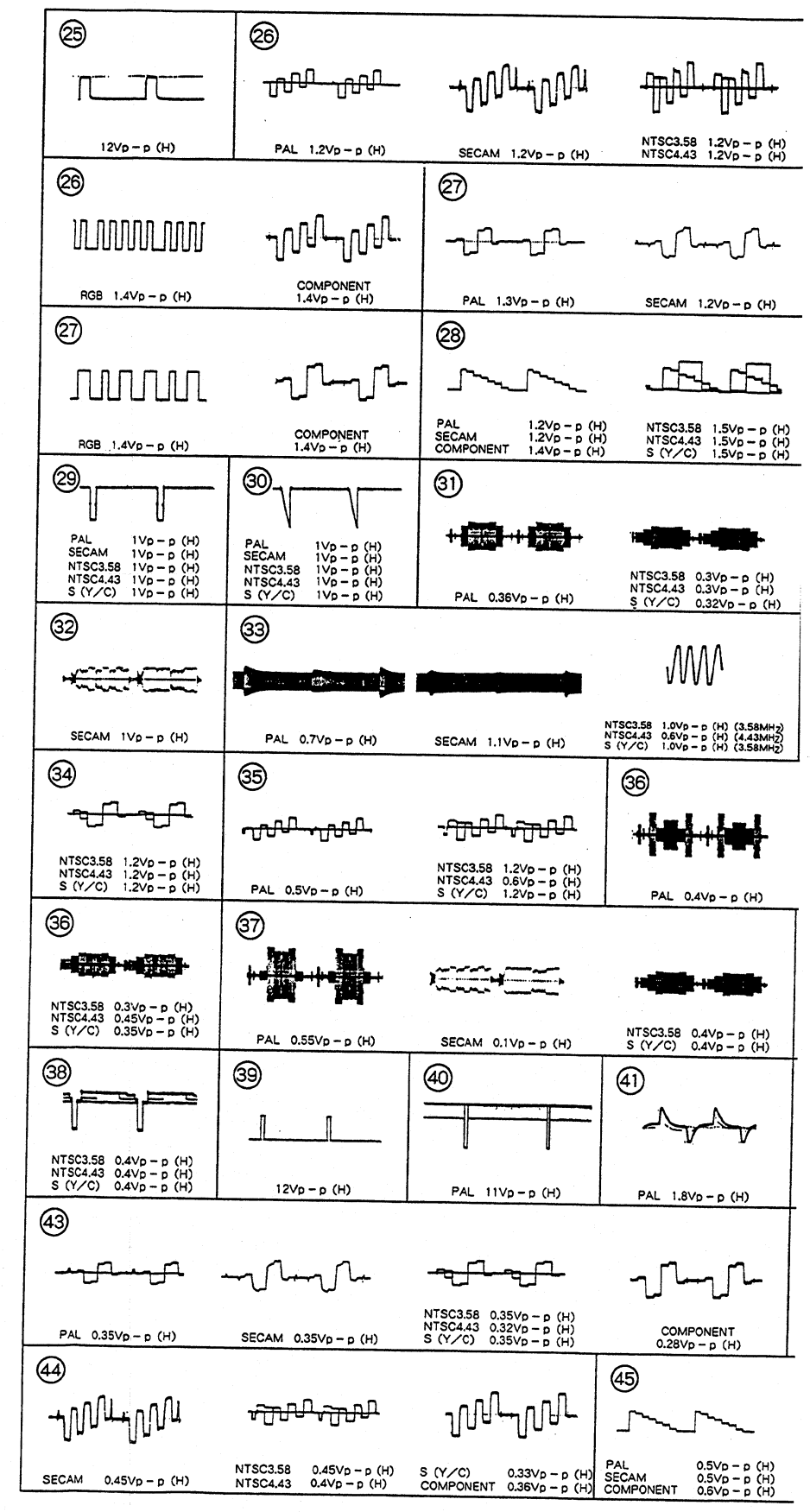
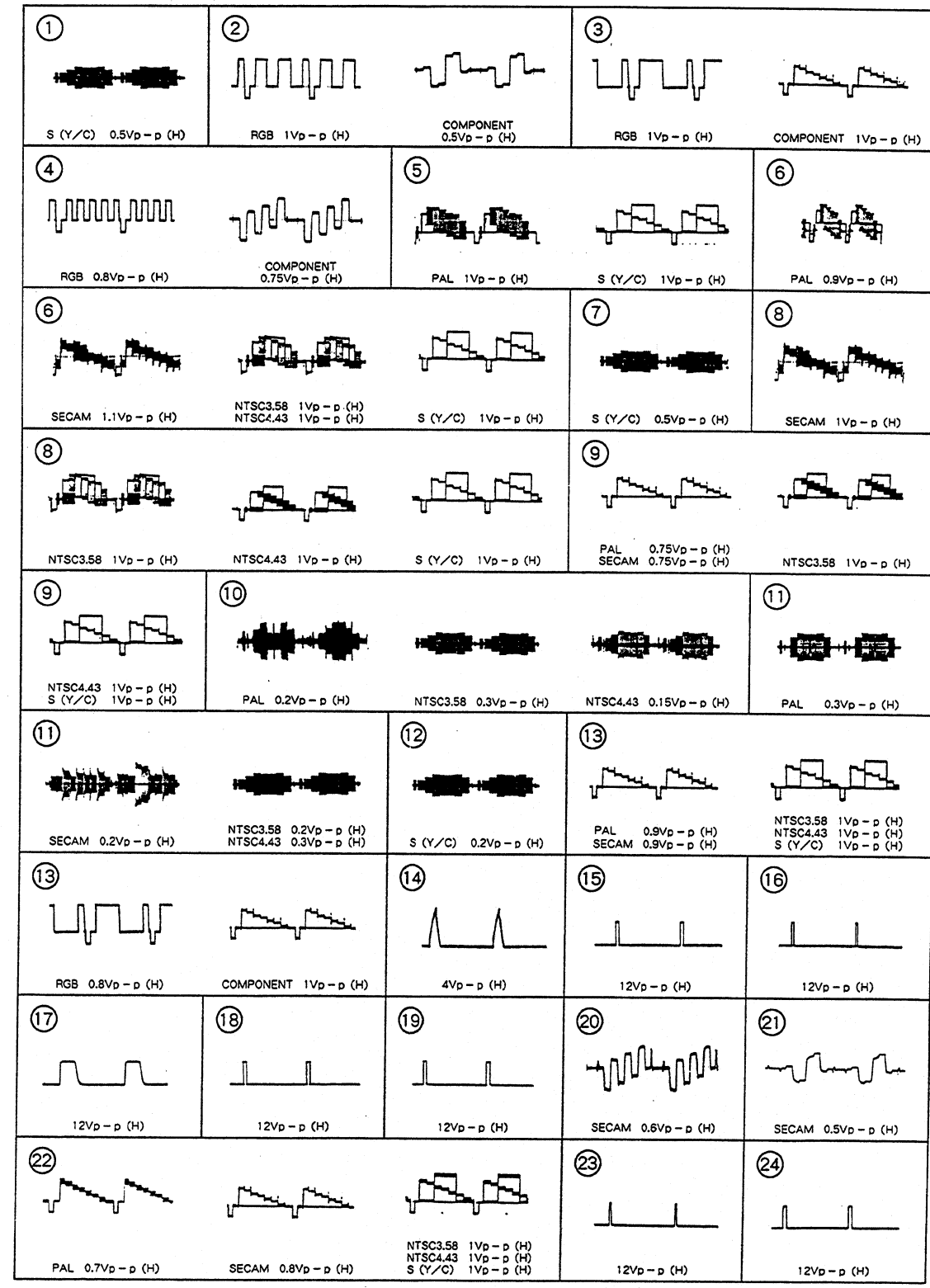

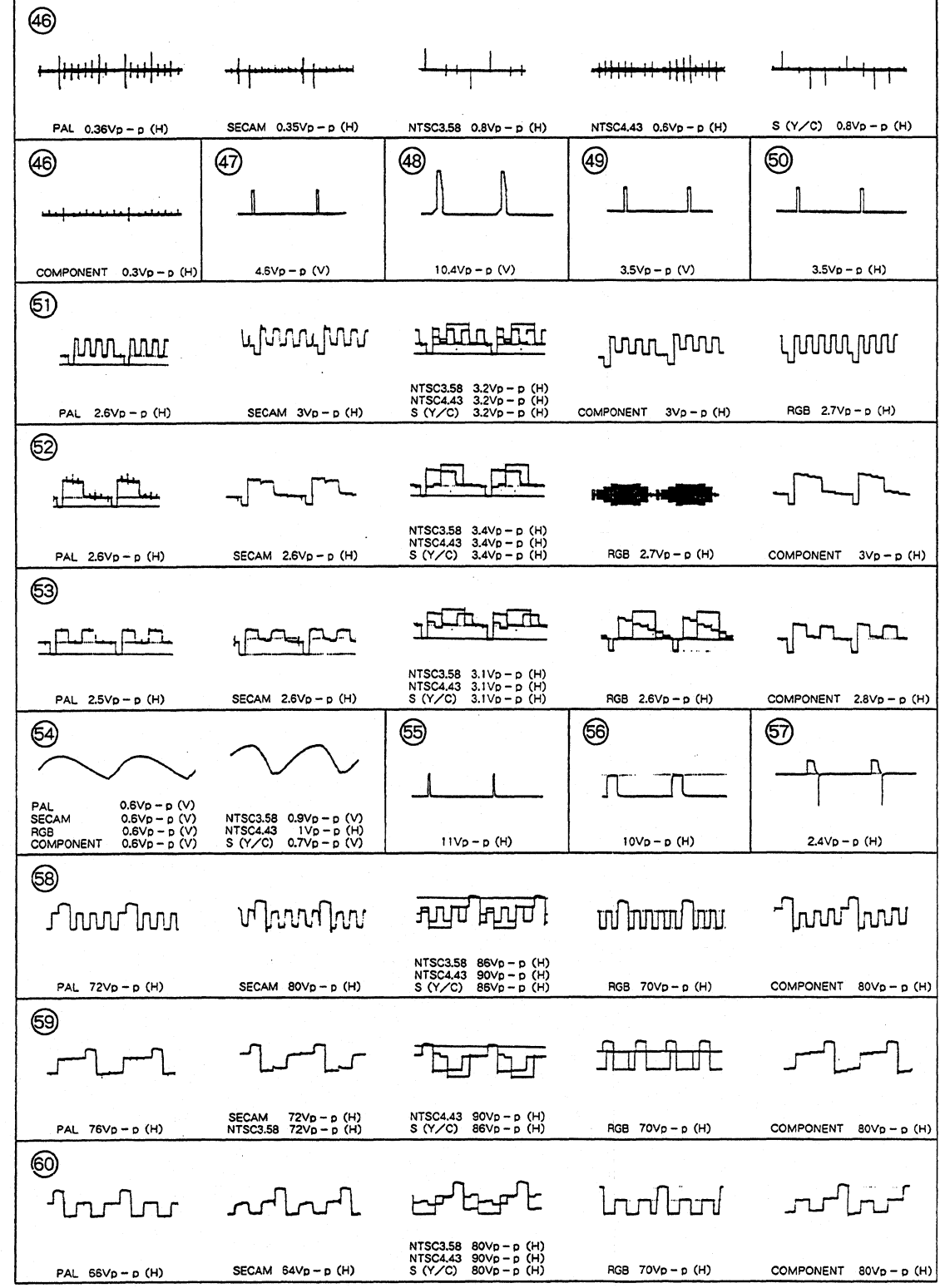
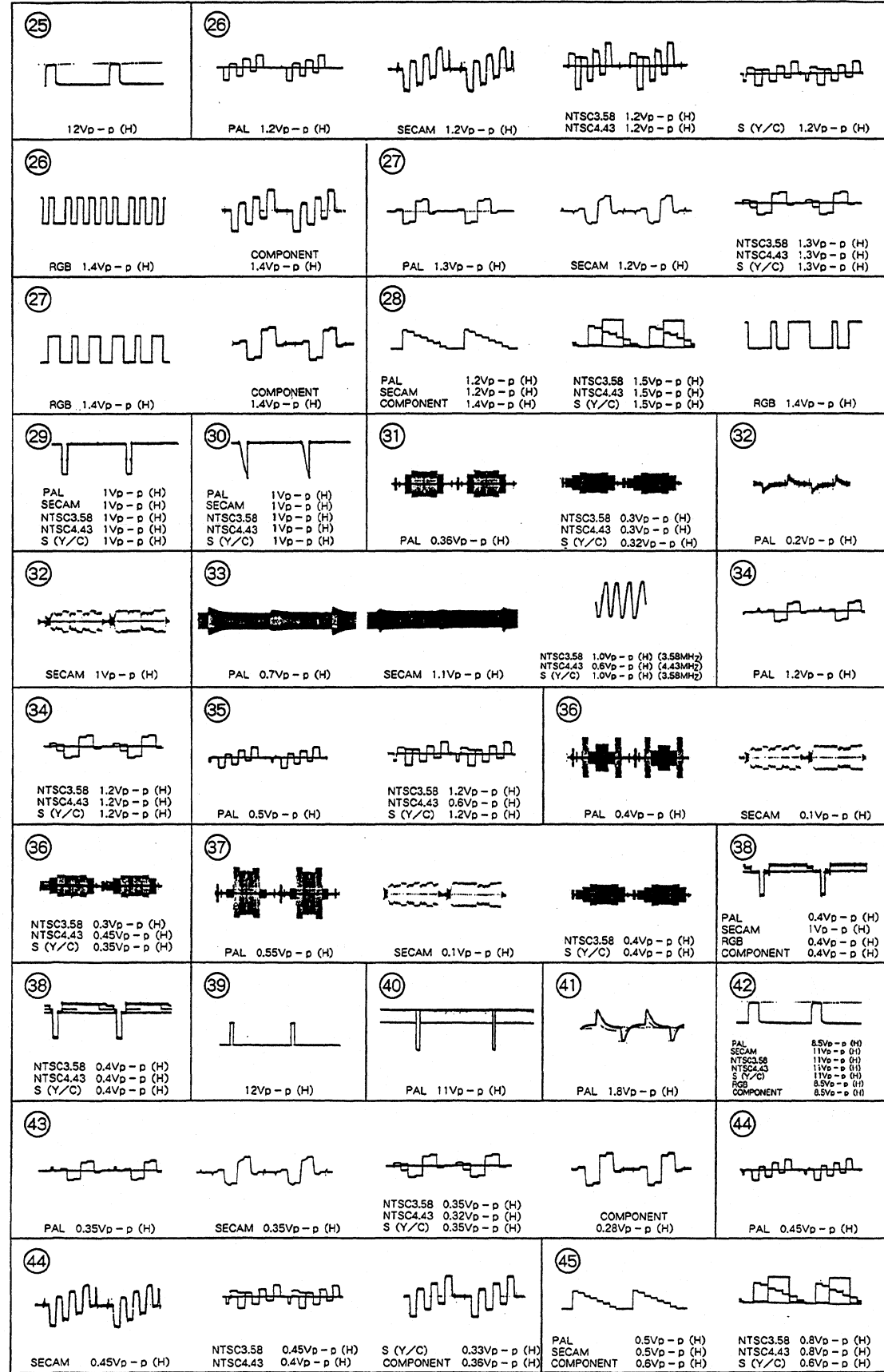
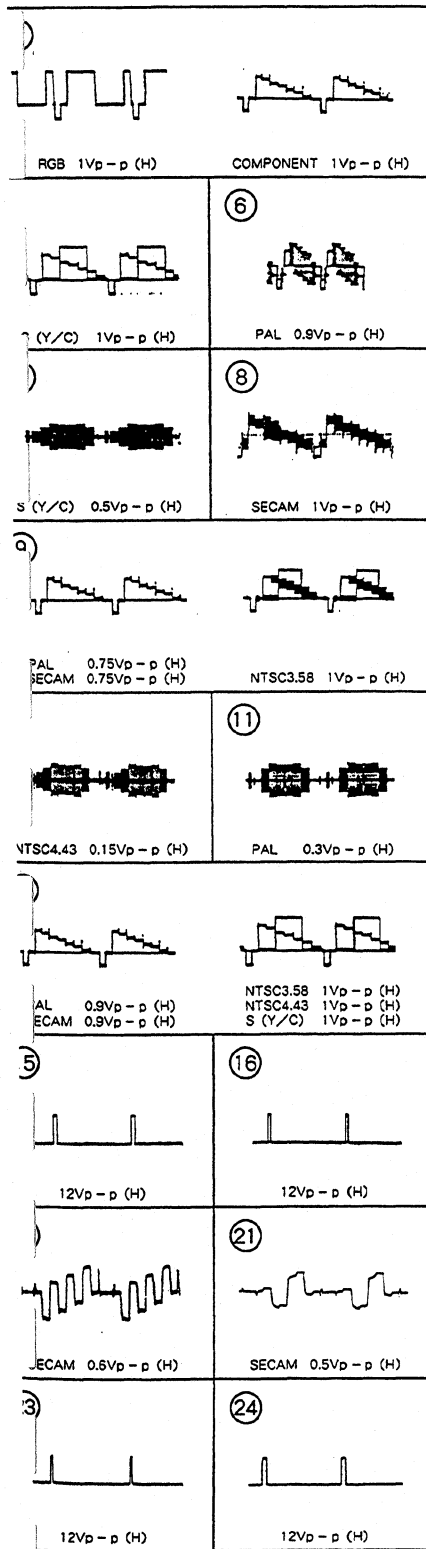

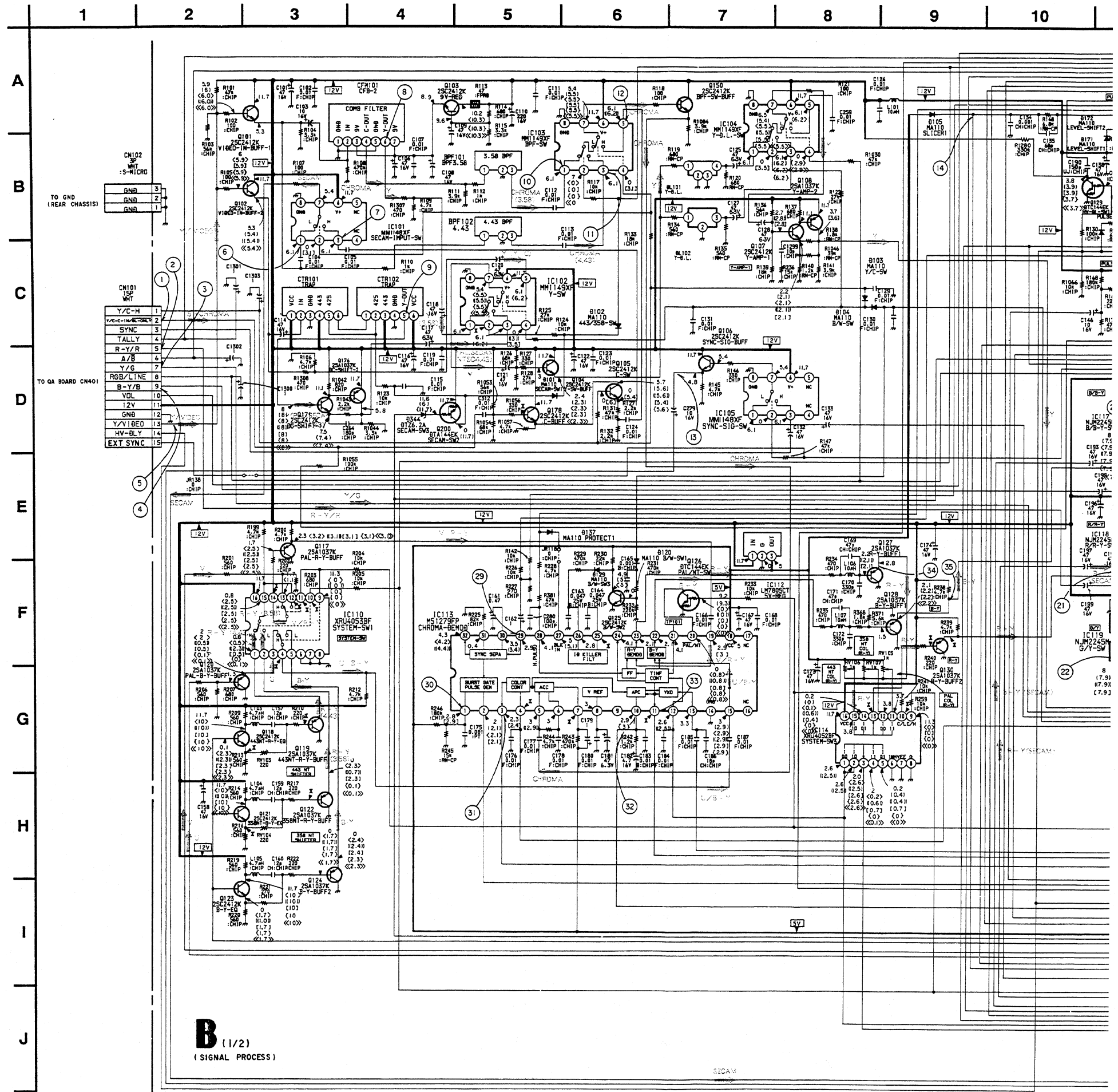

6

7

8

9

10

11

12

13

14

15

16

17

18

19

20

21

22

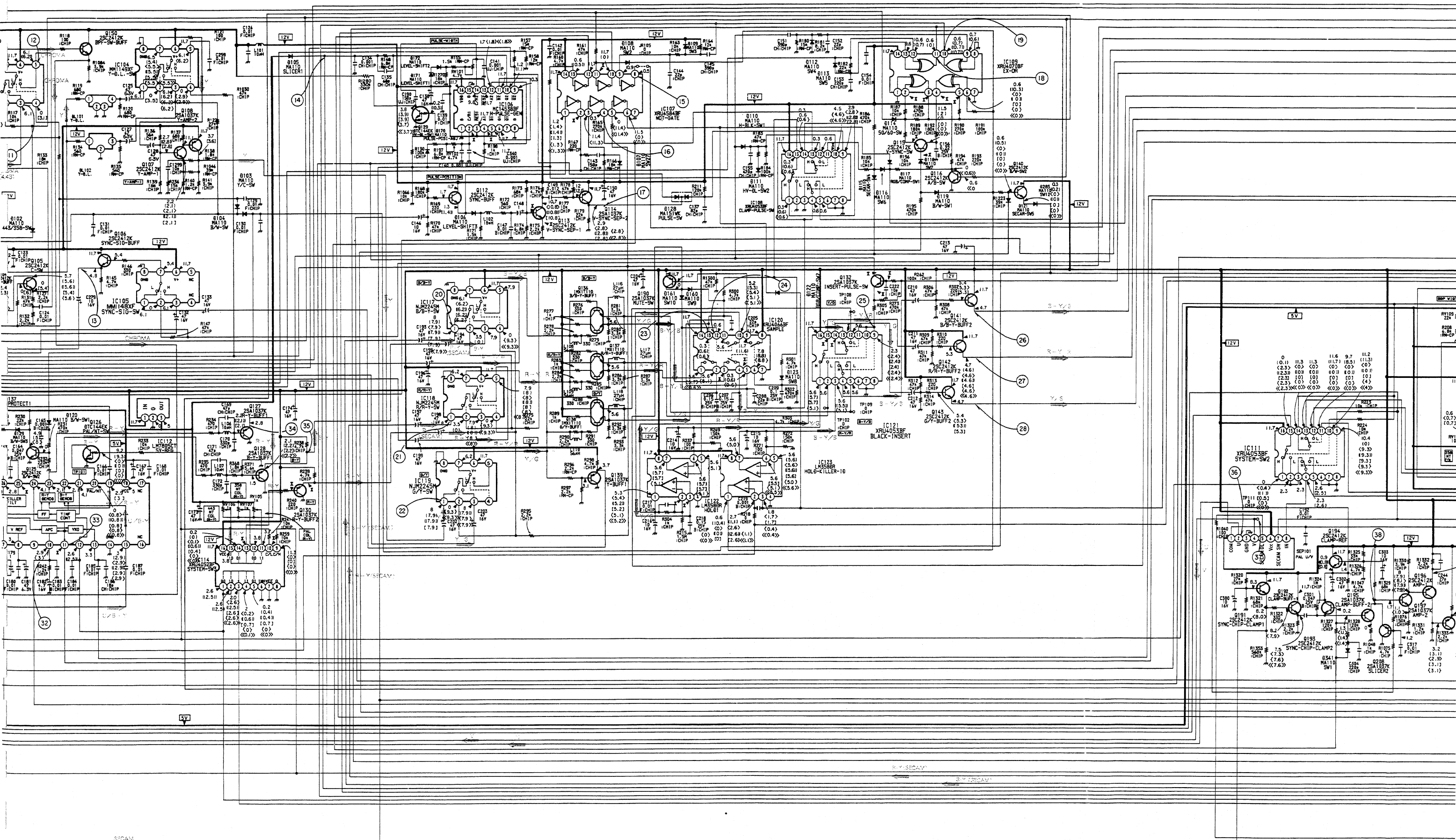

PVM-9041QM/9044QM PVM-9041QM/9044QM

14 15 16 17 18 19 20 21 22 23 24 25 26 27 28 29

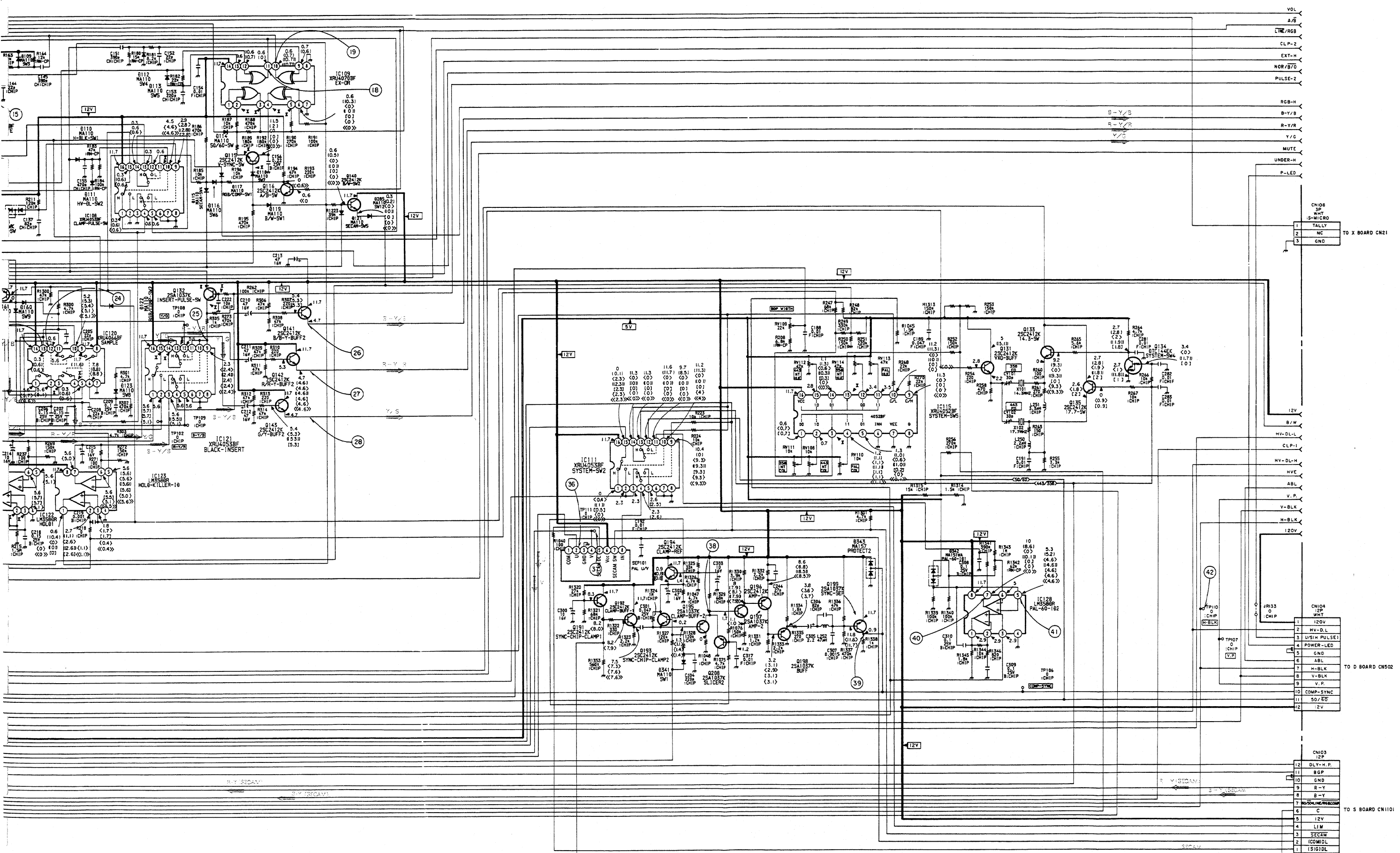

PVM-9041QM/9044QM PVM-9041QM/9044QM

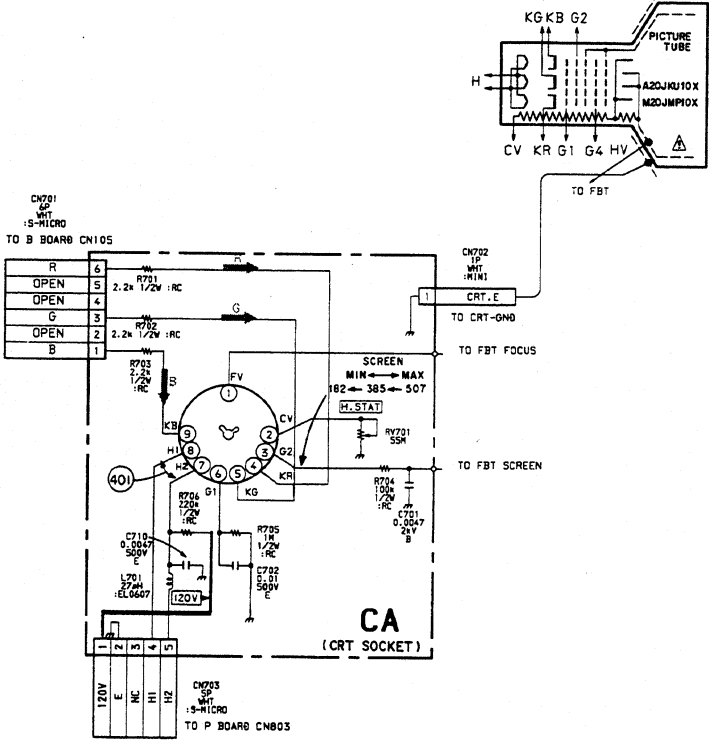
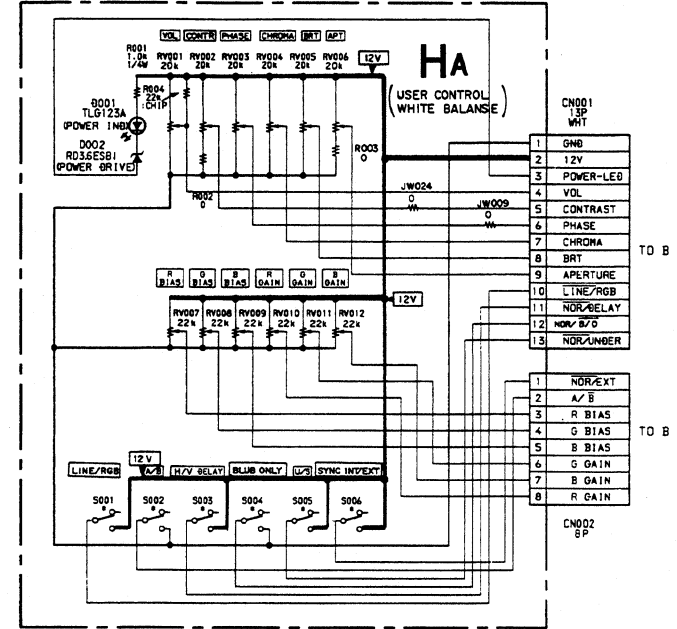
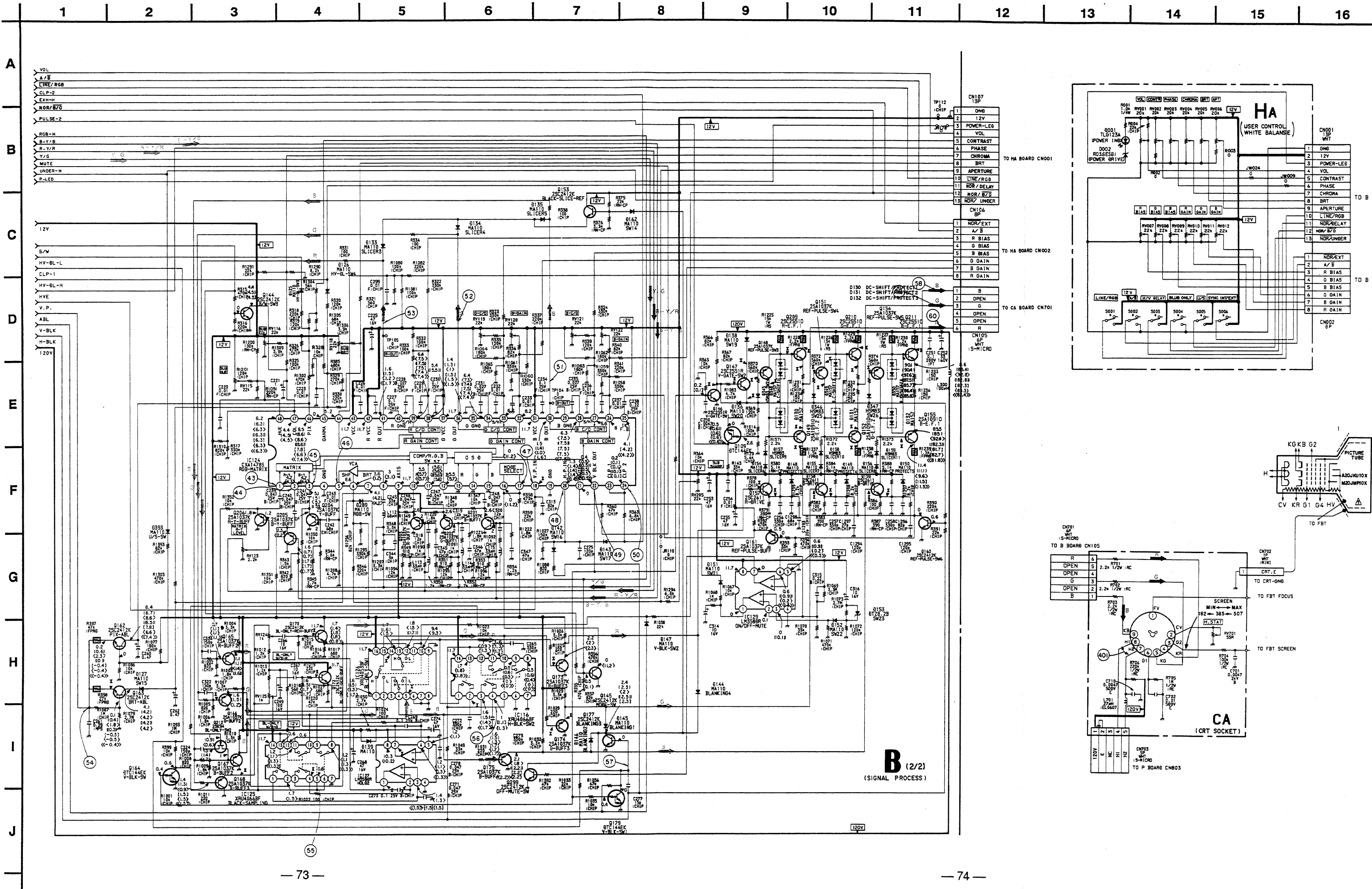

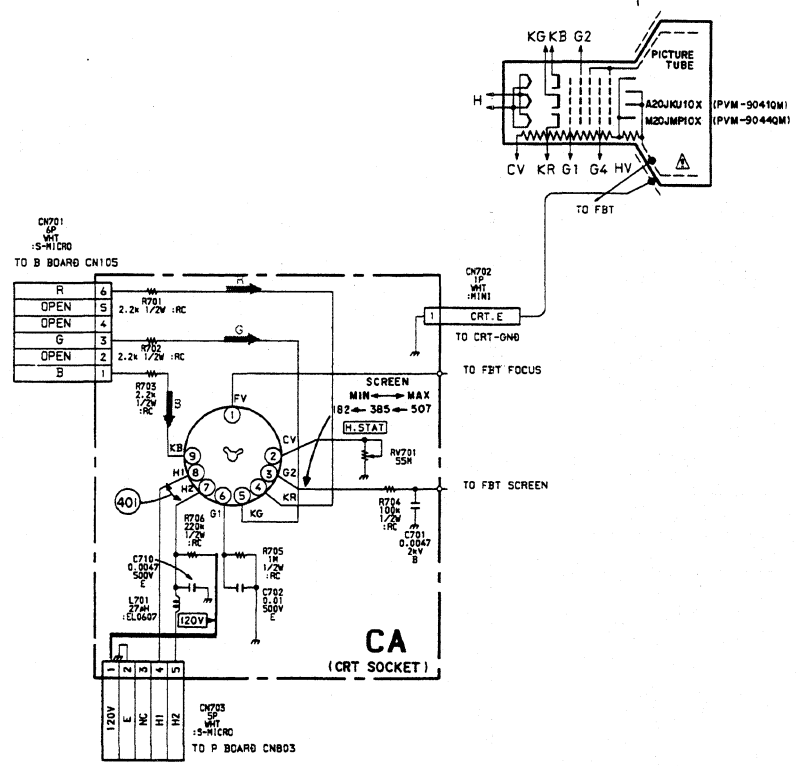
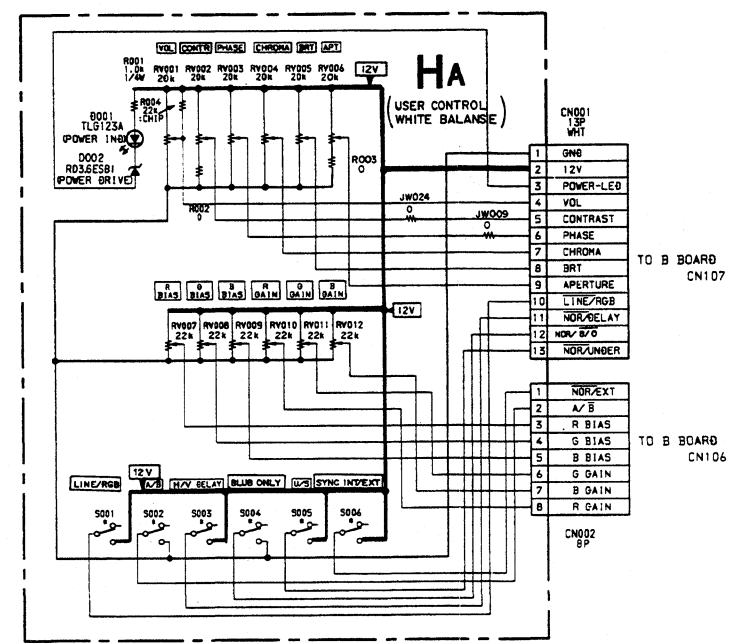
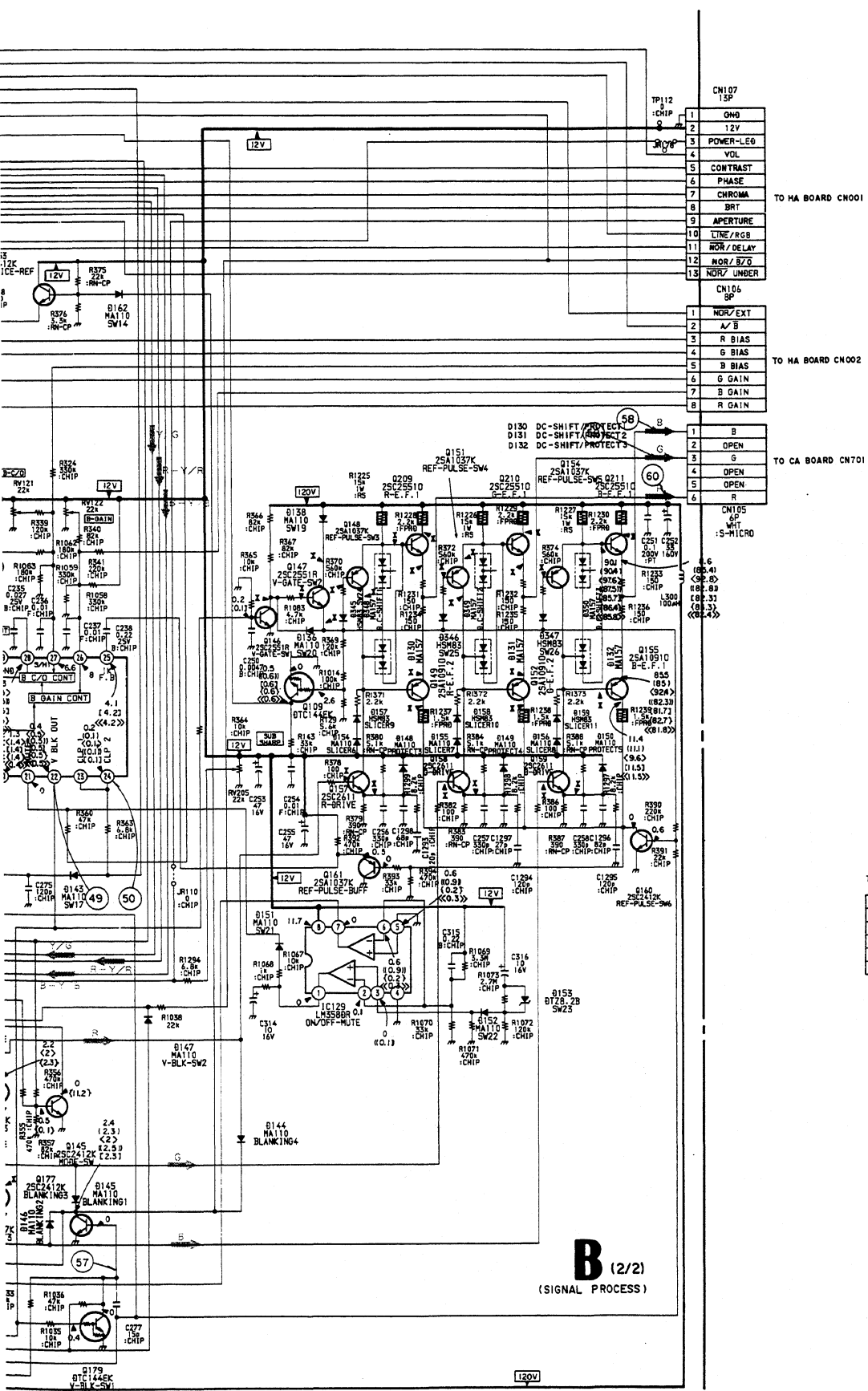

- B Board -

X < TRANSISTOR >

		PAL	SECAM	NTSC 3.58	NTSC 4.43	S (Y/C)	ANALOG RGB	COMPONENT
Q113	E	0.5	0.5	0.4	0.4	0.5	0.5	0.5
	B	1.0	1.0	0.9	0.9	0.9	0.9	1.0
Q115	E	11.2	9.3	0.0	10.8	0.0	0.0	0.0
	B	2.8	2.2	0.1	2.4	0.1	0.1	0.0
Q118	E	0.0	0.0	1.7	1.7	1.7	1.7	1.7
Q119	B	0.1	0.0	1.7	1.7	1.7	1.7	1.7
Q121	E	0.0	0.0	1.7	1.7	1.7	1.7	1.7
Q122	B	0.0	0.0	1.7	1.7	1.7	1.7	1.7
Q130	E	4.3	4.3	4.4	4.4	4.5	4.4	4.4
	B	3.7	3.7	3.8	3.8	3.9	3.8	3.8
Q132	E	2.3	2.3	2.4	2.3	2.4	2.4	2.4
	C	1.8	1.7	1.7	1.7	1.7	1.8	1.8
	B	2.7	2.8	2.8	2.7	2.8	2.7	2.8
Q146	C	116.7	114.4	110.4	113.2	113.7	114.3	114.1
Q147	E	117.9	115.6	111.6	114.5	115.0	115.5	115.4
	C	126.0	123.5	120.3	123.4	123.8	124.6	124.4
	B	119.8	119.5	110.5	118.4	118.2	114.2	114.2
Q148	C	86.1	84.9	81.2	83.4	82.6	82.5	82.2
	B	94.0	93.3	86.3	92.4	92.1	94.2	90.8
Q149	E	1.8	1.8	1.4	1.7	1.7	1.7	1.7
	C	86.1	84.9	81.2	83.4	82.7	82.5	82.5
Q151	E	90.7	91.4	88.0	87.9	87.0	86.5	86.4
	C	89.2	89.8	86.5	86.4	85.3	84.9	84.7
	B	92.1	92.7	100.2	89.5	92.4	90.5	88.9
Q152	E	86.1	86.0	82.6	82.6	82.9	82.6	82.7
	C	10.8	10.5	9.7	10.9	10.9	10.9	11.0
Q154	B	92.5	92.9	99.8	90.1	88.7	90.4	89.2
Q155	B	88.3	88.5	95.7	85.7	83.9	84.6	83.9
Q157	E	82.4	81.1	87.5	79.9	79.9	80.8	79.4
	B	86.0	84.8	91.2	84.4	82.7	82.5	82.1
Q158	E	1.8	1.5	1.3	1.8	1.8	1.7	1.7
	B	2.1	2.0	1.8	2.1	2.2	2.2	2.2
Q159	E	1.8	1.8	1.3	1.8	1.7	1.7	1.7
	B	2.2	2.1	1.5	2.1	2.2	2.2	2.2
Q183	E	0.2	0.6	2.7	0.5	-0.5	-0.7	-0.8
Q186	B	0.9	0.9	0.8	1.0	1.0	1.0	1.0
Q188	C	2.1	2.0	1.8	2.1	2.2	2.1	2.2
Q170	B	2.3	2.3	2.1	2.4	2.4	2.4	2.4
Q172	B	2.2	2.1	1.9	2.2	2.3	2.2	2.3
Q173	B	1.7	1.8	1.4	1.7	1.7	1.7	1.7
Q174	E	2.1	2.0	1.8	2.1	2.2	2.2	2.2
	B	1.8	1.5	1.3	1.8	1.8	1.7	1.7
Q178	B	6.2	6.3	6.2	6.3	6.1	6.2	6.2
Q209	E	83.4	81.5	87.9	80.3	80.4	80.4	79.8
	C	115.8	113.2	110.7	113.2	113.8	114.5	114.2
	B	87.8	86.4	92.8	85.0	84.3	84.2	83.8
Q210	E	86.5	86.3	93.1	83.0	83.3	83.0	82.8
	C	116.5	114.2	111.5	113.9	114.5	115.1	114.9
Q211	C	115.9	113.8	111.7	113.3	113.8	114.5	114.3

< IC >

		PAL	SECAM	NTSC 3.58	NTSC 4.43	S (Y/C)	ANALOG RGB	COMPONENT
IC102	Ⓜ	6.8	6.8	0.0	6.8	0.0	0.0	0.0
IC106	Ⓜ	0.2	0.1	0.1	0.1	0.1	0.1	0.2
	Ⓜ	1.8	1.7	1.7	1.7	1.7	1.8	1.8
IC107	Ⓜ	10.7	10.7	10.8	10.6	10.8	10.6	10.6
	Ⓜ	1.2	10.7	0.0	0.0	0.0	0.0	0.0
IC108	Ⓜ	9.7	0.4	9.7	9.8	9.6	1.1	9.8
IC109	Ⓜ	11.3	11.3	0.0	10.8	0.0	0.0	0.0
	Ⓜ	11.3	11.4	0.0	11.3	0.0	0.0	0.0
	Ⓜ	11.7	0.0	0.0	11.7	0.0	0.0	0.0
	Ⓜ	11.0	11.1	0.0	11.0	0.0	0.0	0.0
IC110	Ⓜ	2.1	2.2	2.5	2.5	2.5	2.5	2.5
	Ⓜ	11.3	11.3	0.0	11.3	0.0	0.0	0.0
	Ⓜ	11.3	11.3	0.0	0.0	0.0	0.0	0.0
	Ⓜ	0.8	0.8	2.5	2.5	2.5	2.5	2.5
	Ⓜ	1.7	1.7	2.5	2.6	2.5	2.5	2.5
IC113	Ⓜ	2.7	1.1	2.8	2.8	2.8	1.1	1.1
	Ⓜ	4.2	4.3	4.2	4.3	4.3	4.8	4.8
	Ⓜ	3.0	2.9	2.8	3.0	2.8	2.9	2.9
	Ⓜ	2.2	2.5	2.9	2.2	1.9	2.8	2.8
IC114	Ⓜ	11.4	11.3	0.0	0.0	0.0	0.0	0.0
	Ⓜ	3.7	3.7	3.8	3.8	3.8	3.9	3.9
IC115	Ⓜ	1.2	1.1	0.8	0.7	0.7	0.8	0.8
	Ⓜ	3.5	3.5	3.4	2.8	3.4	3.4	3.4
IC118	Ⓜ	0.0	0.0	1.0	1.1	1.1	1.3	1.1
IC120	Ⓜ	5.5	5.8	5.8	5.8	5.8	5.8	5.8
	Ⓜ	5.5	5.8	5.8	5.8	5.8	5.0	5.8
IC121	Ⓜ	5.3	5.3	5.4	5.2	5.2	5.1	5.1
	Ⓜ	5.8	5.7	5.8	5.8	5.7	5.7	5.7
	Ⓜ	5.8	5.7	5.8	5.8	5.7	5.7	5.8
IC122	Ⓜ	5.3	5.3	5.4	5.2	5.2	5.1	5.1
	Ⓜ	5.3	5.3	5.4	5.2	5.2	5.1	5.1
IC124	Ⓜ	0.1	0.1	0.2	0.2	0.2	0.2	0.2
IC125	Ⓜ	1.4	1.4	1.3	1.4	1.5	1.5	1.5
IC126	Ⓜ	1.6	1.5	1.3	1.6	1.6	1.7	1.8
	Ⓜ	1.8	1.5	1.3	1.8	1.8	1.8	1.7
	Ⓜ	1.7	1.8	1.4	1.7	1.7	1.8	1.7
IC127	Ⓜ	3.0	2.9	2.8	3.0	3.1	3.0	3.0
	Ⓜ	1.4	1.4	1.3	1.5	1.5	1.5	1.5
	Ⓜ	2.1	2.7	2.4	2.8	2.8	2.8	2.8

CA BOARD WAVEFORM

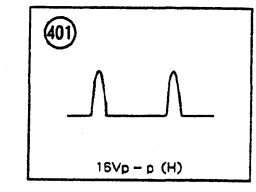

6-6. SEMICONDUCTORS

AN5265

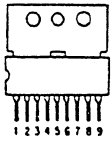

LM358D
LM358DR
MM1148XFF
MM1149XF
NJM2245M
XRA10393F

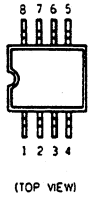

XRU4052BF
XRU4053BF
XRU4066BF



2SC2334-L
2SD1134

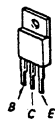

ERC81-004

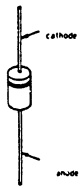

MA157
1SS226

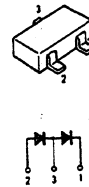

CXA1214P

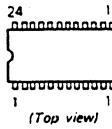

2SC2611
2SC2688



GP08DPK23
HSM83-TL
RD5.6EBZ7STN
1SS83
1SS83TD

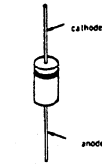

N13T1

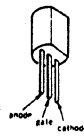

CXA1478S

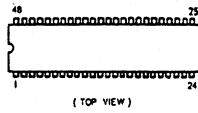

MC14538BF

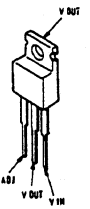

XRU4584BF



2SC3736

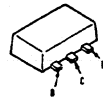

MA110

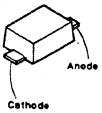

RD3.6ESB1
RD5.6ESB2
RD8.2ESB3

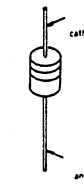

CX23025

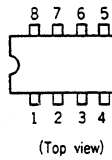

M51279FP

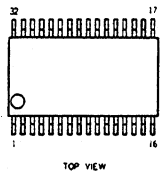

DTA144EK
DTC144EK
2SA1037K
2SA1162-G
2SC2412K



2SK94

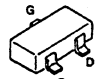

MA151WA
1S2836

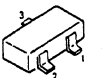

SEL3810DLC05
SLP281C-50
TLG123A



LA7830

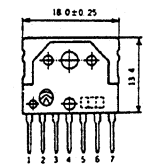

μPC1377C

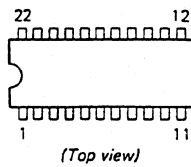

IMX1
IMX1T110

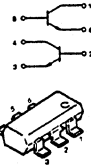

DTZ15B
DTZ20B
DTZ24B
DTZ5.6A
DTZ6.2-TT11
DTZ6.2B
DTZ8.2B
RD15SB1

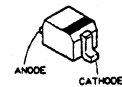

MA151WK
MA152WK

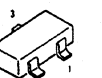

U05G

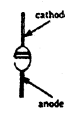

LM7805CT
LM7812CT
MC7812CT

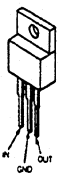

XRU4011BF
XRU4070BF

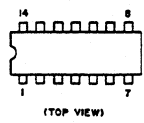

2SA1091-0
2SC1890-A
2SC2551-0
2SC2551R

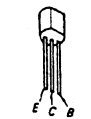

D10SC4M

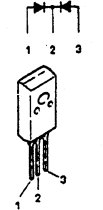

NOTE:
• Items with not stocker routine ser
• The constr indicated v column.

7-1. CH/

● : BVTP3
▲ : BVTP3



REF. NO.	PART
1	X-40
1	X-40
2	4-03
3	*4-03
4	*4-03
5	*4-03
6	*1-64
7	1-54
8	*A-11
9	*A-13
10	Δ1-41
11	A-13
12	Δ1-57
13	*A-11
14	Δ1-43

SECTION 7 EXPLODED VIEWS

MA157
1SS226



N13T1

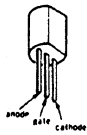

RD3.6ESB1
RD5.6ESB2
RD8.2ESB3

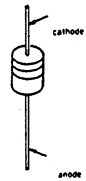

SEL3810DLC05
SLP281C-50
TLG123A

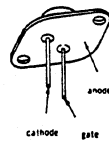

U05G

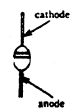

NOTE:

- Items with no part number and no description are not stocked because they are seldom required for routine service.
- The construction parts of an assembled part are indicated with a collation number in the remark column.
- Items marked "*" are not stocked since they are seldom required for routine service. Some delay should be anticipated when ordering these items.

The components identified by shading and mark **▲** are critical for safety. Replace only with part number specified.

7-1. CHASSIS

- : BVTP3x8 7-685-646-79
- ▲ : BVTP3x12 7-685-648-79

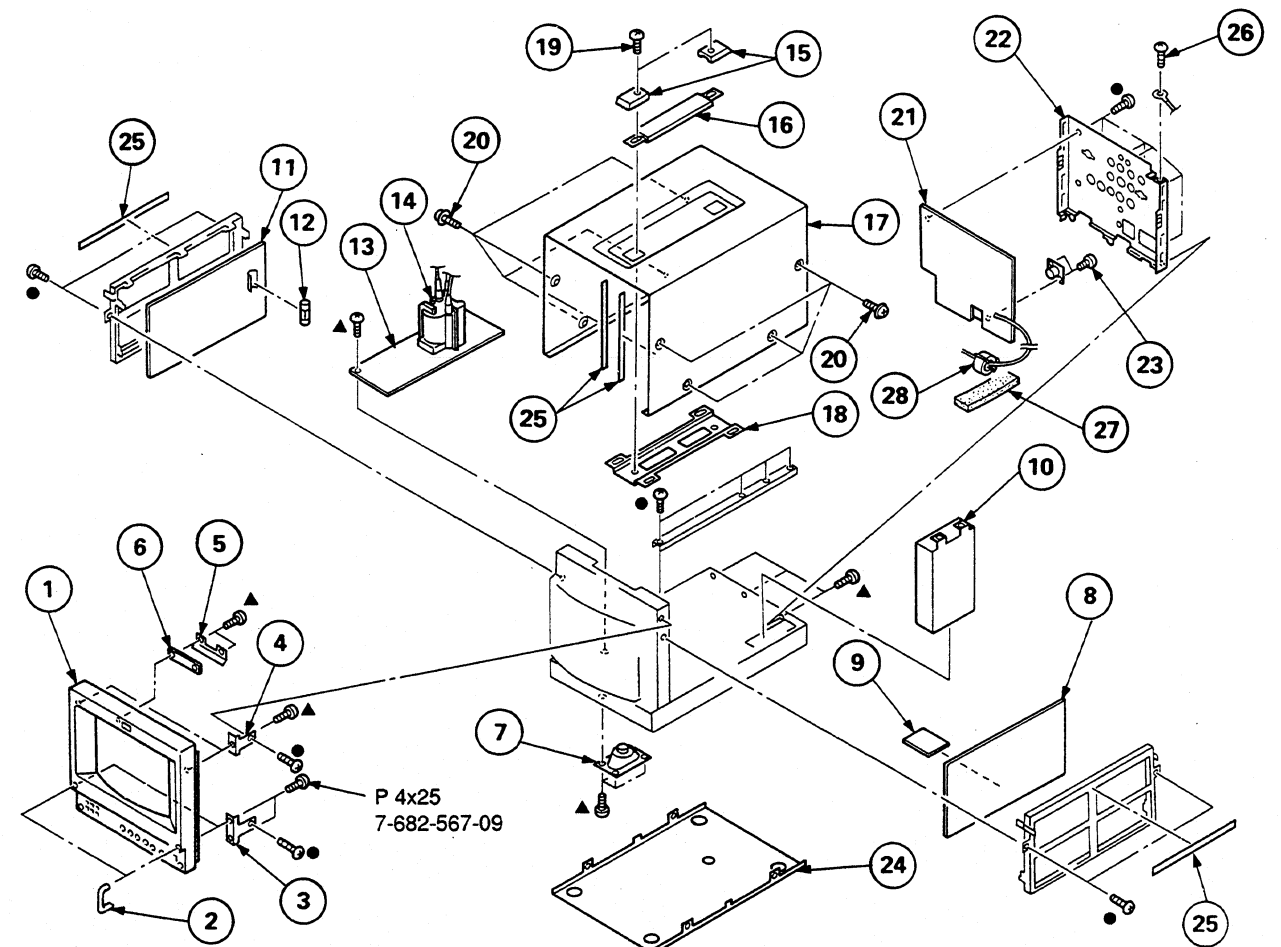

REF. NO.	PART NO.	DESCRIPTION	REMARK	REF. NO.	PART NO.	DESCRIPTION	REMARK
1	X-4030-164-6	BEZEL ASSY (PVM-9041QM only)		15	4-034-847-01	HANDLE (BASE)	
1	X-4030-278-1	BEZEL ASSY (PVM-9044QM only)		16	3-419-372-31	HANDLE	
2	4-034-844-01	HANDLE, PROTECTOR		17	*4-034-867-01	CABINET	
3	*4-034-845-01	BRACKET (L), BEZEL		18	*X-4030-273-1	REINFORCEMENT ASSY, HANDLE	
4	*4-034-846-01	BRACKET (U), BEZEL		19	4-035-452-01	SCREW (M4X10)	
5	*4-035-388-01	PLATE, LIGHT INTERCEPTION		20	4-034-834-01	SCREW (CLAW) (4X6)	
6	*1-641-724-11	PC BOARD, X		21	A-1275-099-A	QA BOARD, COMPLETE	
7	1-544-252-11	SPEAKER		22	*4-034-864-01	CHASSIS, R	
8	*A-1135-716-A	B BOARD, COMPLETE		23	4-035-802-01	SCREW (M2, 6X6)	
9	*A-1394-368-A	S BOARD, COMPLETE		24	*4-034-870-02	CABINET, BOTTOM	
10	▲1-413-720-21	SWITCHING REGULATOR		25	*4-035-691-01	CLOTH, VIBRATION PROOF	
11	A-1346-018-A	D BOARD, COMPLETE		26	4-389-025-01	SCREW (M4X8) (EXT TOOTH WASHER)	
12	▲1-576-232-11	FUSE (H. B. C.) (5A 250V)		27	*4-036-058-01	SPONGE	
13	*A-1195-048-A	P BOARD, COMPLETE		28	1-543-925-11	CORE, FERRITE	
14	▲1-439-526-11	TRANSFORMER ASSY, FLYBACK					

7-2. PICTURE TUBE

▲ : BVTP3x12 7-685-648-79

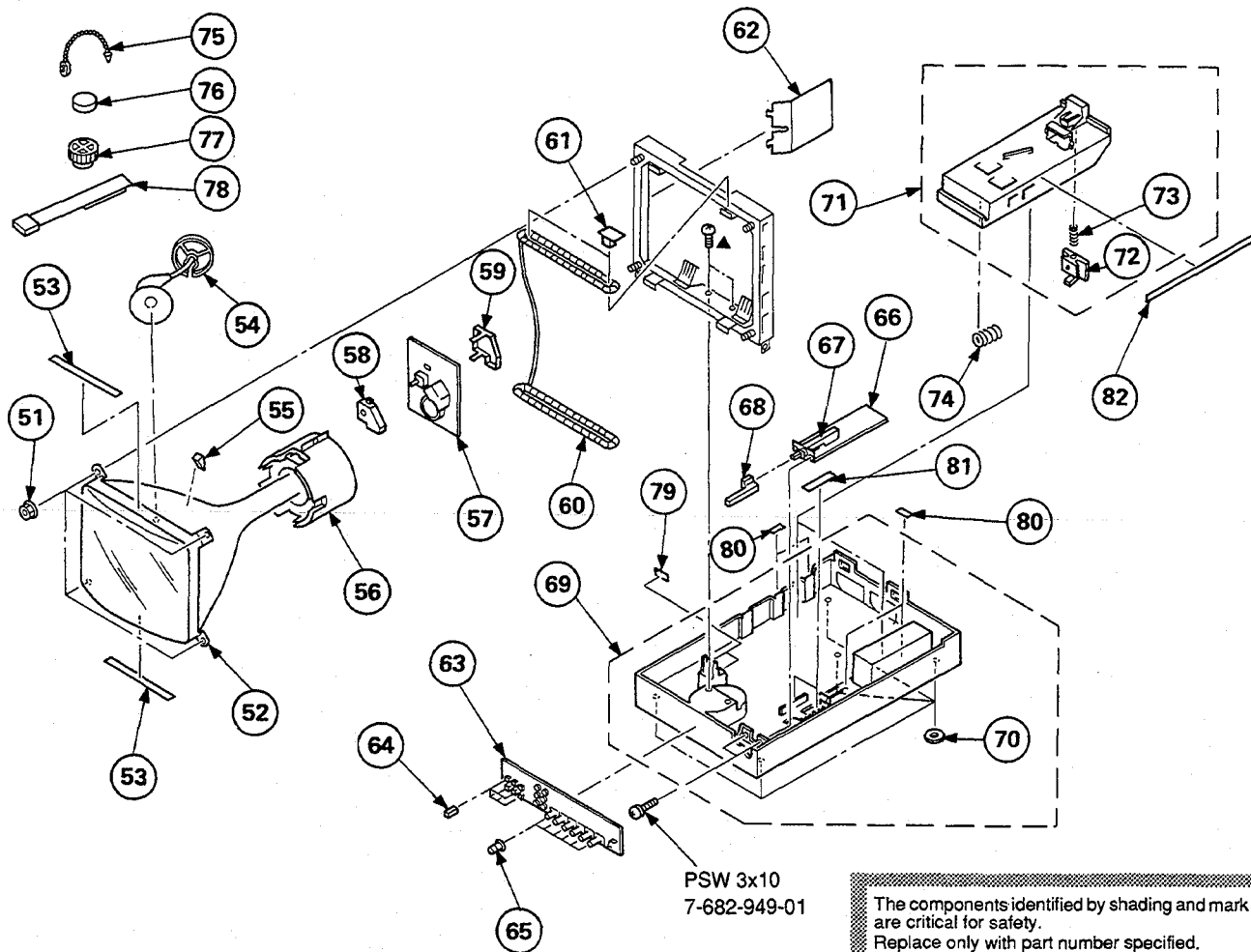

The components identified by shading and mark ▲ are critical for safety. Replace only with part number specified.

REF. NO.	PART NO.	DESCRIPTION	REMARK	REF. NO.	PART NO.	DESCRIPTION	REMARK
51	4-304-511-00	FLANGE NUT, 5MM		67	▲1-692-050-11	SWITCH, PUSH (AC POWER) (1 KEY)	
52	▲ 8-737-151-05	CRT A20JKU10X (PVM-9041QM only)		68	4-034-841-01	SWITCH, POWER	
52	▲ 8-737-651-05	CRT A20JMP10X (PVM-9044QM only)		69	*X-4030-166-1	CHASSIS ASSY, BOTTOM	
53	4-035-332-01	CLOTH, PROTECTION		70	4-034-840-01	RUBBER, FOOT	
54	*4-034-856-01	HOLDER, HV CABLE		71	*X-4030-163-1	GUIDE ASSY, BATTERY	
55	4-309-369-00	SPACER, DEFLECTION YOKE		72	4-034-861-01	KNOB, BATTERY	
56	▲ 1-451-319-22	DEFLECTION YOKE (Y9FXC)		73	4-876-347-01	SPRING, COMPRESSION	
57	*1-641-720-11	CA BOARD		74	3-669-594-00	SPRING, COMPRESSION	
58	*4-376-133-11	COVER (MAIN), CV VOL		75	4-308-870-00	CLIP, LEAD WIRE	
59	*4-376-132-11	COVER (REAR LID), CV VOL		76	1-452-126-11	MAGNET	
60	▲ 1-426-043-00	COIL, DEGAUSSING		77	1-452-094-00	MAGNET, ROTATABLE DISK; 15 MM φ	
61	4-380-534-01	CAP, DGC		78	X-4308-815-0	PERMALLOY ASSY, CONVERGENCE	
62	*4-034-850-01	INSULATOR		79	*4-036-047-02	RUBBER, VIBRATION PROOF	
63	*A-1371-782-A	HA BOARD, MOUNTED		80	3-839-640-00	CUSHION	
64	4-034-849-01	SWITCH (SMALL), PUSH		81	3-831-441-11	CUSHION (F)	
65	X-4030-162-1	KNOB ASSY, CONTROL		82	*4-035-691-01	CLOTH, VIBRATION PROOF	
66	*1-641-723-11	FA BOARD					

B

SECTION 8 ELECTRICAL PARTS LIST

NOTE:

The components identified by shading and mark **▲** are critical for safety.
Replace only with part number specified.

- Items marked "*" are not stocked since they are seldom required for routine service. Some delay should be anticipated when ordering these items.

When indicating parts by reference number, please include the board name.

- All variable and adjustable resistors have characteristic curve B, unless otherwise noted.

CAPACITORS **COILS**

- MF: μ F, PF: μ MF
- MMH: mH, UH: μ H
- The components identified by **▲** in this manual have been carefully factory-selected for each set in order to satisfy regulations regarding X-ray radiation.
- Should replacement be required, replace only with the value originally used.

RESISTORS

- All resistors are in ohms
- F: nonflammable

REF. NO.	PART NO.	DESCRIPTION	REMARK	REF. NO.	PART NO.	DESCRIPTION	REMARK
*A-1135-716-A	B BOARD, COMPLETE	*****		C142	1-163-031-11	CERAMIC CHIP 0.01MF	50V
3-710-578-01	COVER, VOLUME, 6 MOLD			C143	1-163-121-00	CERAMIC CHIP 150PF	5% 50V
	<FILTER>			C144	1-163-101-00	CERAMIC CHIP 22PF	5% 50V
BPF101	1-236-363-11	FILTER, BAND PASS		C145	1-163-131-00	CERAMIC CHIP 390PF	5% 50V
BPF102	1-236-364-11	FILTER, BAND PASS		C146	1-126-157-11	ELECT 10MF	20% 16V
	<CAPACITOR>			C147	1-164-232-11	CERAMIC CHIP 0.01MF	10% 50V
C101	1-124-589-11	ELECT 47MF	20% 16V	C148	1-126-160-11	ELECT 1MF	20% 50V
C102	1-163-031-11	CERAMIC CHIP 0.01MF	50V	C149	1-163-022-00	CERAMIC CHIP 0.012MF	10% 50V
C103	1-126-157-11	ELECT 10MF	20% 16V	C150	1-124-589-11	ELECT 47MF	20% 16V
C104	1-163-031-11	CERAMIC CHIP 0.01MF	50V	C151	1-163-131-00	CERAMIC CHIP 390PF	5% 50V
C105	1-163-031-11	CERAMIC CHIP 0.01MF	50V	C152	1-163-101-00	CERAMIC CHIP 22PF	5% 50V
C106	1-124-477-11	ELECT 47MF	20% 16V	C153	1-163-125-00	CERAMIC CHIP 220PF	5% 50V
C107	1-163-031-11	CERAMIC CHIP 0.01MF	50V	C154	1-163-031-11	CERAMIC CHIP 0.01MF	50V
C108	1-124-477-11	ELECT 47MF	20% 16V	C155	1-163-133-00	CERAMIC CHIP 470PF	5% 50V
C109	1-124-477-11	ELECT 47MF	20% 16V	C156	1-164-299-11	CERAMIC CHIP 0.22MF	10% 25V
C110	1-124-120-11	ELECT 220MF	20% 16V	C157	1-163-229-11	CERAMIC CHIP 12PF	5% 50V
C111	1-163-031-11	CERAMIC CHIP 0.01MF	50V	C158	1-124-477-11	ELECT 47MF	20% 16V
C112	1-163-031-11	CERAMIC CHIP 0.01MF	50V	C159	1-163-229-11	CERAMIC CHIP 12PF	5% 50V
C113	1-163-031-11	CERAMIC CHIP 0.01MF	50V	C160	1-163-229-11	CERAMIC CHIP 12PF	5% 50V
C114	1-124-477-11	ELECT 47MF	20% 16V	C161	1-124-902-00	ELECT 0.47MF	20% 50V
C115	1-163-031-11	CERAMIC CHIP 0.01MF	50V	C162	1-124-903-11	ELECT 1MF	20% 50V
C116	1-124-589-11	ELECT 47MF	20% 16V	C163	1-163-809-11	CERAMIC CHIP 0.047MF	10% 25V
C117	1-126-154-11	ELECT 47MF	20% 6.3V	C164	1-163-809-11	CERAMIC CHIP 0.047MF	10% 25V
C118	1-126-154-11	ELECT 47MF	20% 6.3V	C165	1-163-009-11	CERAMIC CHIP 0.001MF	10% 50V
C119	1-163-031-11	CERAMIC CHIP 0.01MF	50V	C166	1-163-031-11	CERAMIC CHIP 0.01MF	50V
C120	1-126-154-11	ELECT 47MF	20% 6.3V	C167	1-124-477-11	ELECT 47MF	20% 16V
C121	1-124-477-11	ELECT 47MF	20% 16V	C168	1-163-031-11	CERAMIC CHIP 0.01MF	50V
C122	1-124-477-11	ELECT 47MF	20% 16V	C169	1-163-243-11	CERAMIC CHIP 47PF	5% 50V
C123	1-163-031-11	CERAMIC CHIP 0.01MF	50V	C170	1-163-129-00	CERAMIC CHIP 330PF	5% 50V
C124	1-163-031-11	CERAMIC CHIP 0.01MF	50V	C171	1-163-243-11	CERAMIC CHIP 47PF	5% 50V
C125	1-126-154-11	ELECT 47MF	20% 6.3V	C172	1-163-129-00	CERAMIC CHIP 330PF	5% 50V
C126	1-163-031-11	CERAMIC CHIP 0.01MF	50V	C173	1-124-589-11	ELECT 47MF	20% 16V
C127	1-126-154-11	ELECT 47MF	20% 6.3V	C174	1-124-477-11	ELECT 47MF	20% 16V
C128	1-126-154-11	ELECT 47MF	20% 6.3V	C175	1-108-792-11	MYLAR 0.001MF	5% 50V
C129	1-163-031-11	CERAMIC CHIP 0.01MF	50V	C176	1-163-031-11	CERAMIC CHIP 0.01MF	50V
C130	1-163-031-11	CERAMIC CHIP 0.01MF	50V	C177	1-163-031-11	CERAMIC CHIP 0.01MF	50V
C131	1-163-031-11	CERAMIC CHIP 0.01MF	50V	C178	1-163-031-11	CERAMIC CHIP 0.01MF	50V
C132	1-124-589-11	ELECT 47MF	20% 16V	C179	1-126-160-11	ELECT 1MF	20% 50V
C133	1-124-589-11	ELECT 47MF	20% 16V	C180	1-163-031-11	CERAMIC CHIP 0.01MF	50V
C134	1-163-275-11	CERAMIC CHIP 0.001MF	5% 50V	C181	1-126-154-11	ELECT 47MF	20% 6.3V
C135	1-163-113-00	CERAMIC CHIP 68PF	5% 50V	C182	1-126-163-11	ELECT 4.7MF	20% 16V
C137	1-163-115-00	CERAMIC CHIP 82PF	5% 50V	C183	1-164-232-11	CERAMIC CHIP 0.01MF	10% 50V
C138	1-124-589-11	ELECT 47MF	20% 16V	C184	1-163-031-11	CERAMIC CHIP 0.01MF	50V
C139	1-163-031-11	CERAMIC CHIP 0.01MF	50V	C185	1-163-031-11	CERAMIC CHIP 0.01MF	50V
C140	1-163-205-00	CERAMIC CHIP 0.001MF	5% 50V	C186	1-163-099-00	CERAMIC CHIP 18PF	5% 50V
C141	1-163-141-00	CERAMIC CHIP 0.001MF	5% 50V	C187	1-163-031-11	CERAMIC CHIP 0.01MF	50V
				C188	1-163-031-11	CERAMIC CHIP 0.01MF	50V
				C189	1-163-035-00	CERAMIC CHIP 0.047MF	50V
				C190	1-163-121-00	CERAMIC CHIP 150PF	5% 50V
				C191	1-163-031-11	CERAMIC CHIP 0.01MF	50V

B

REF. NO.	PART NO.	DESCRIPTION	REMARK	REF. NO.	PART NO.	DESCRIPTION	REMARK
C192	1-163-031-11	CERAMIC CHIP 0.01MF	50V	C259	1-163-031-11	CERAMIC CHIP 0.01MF	50V
C193	1-124-589-11	ELECT 47MF	20% 16V	C260	1-124-465-00	ELECT 0.47MF	20% 50V
C194	1-124-589-11	ELECT 47MF	20% 16V	C261	1-137-193-11	FILM 0.39MF	5% 50V
C195	1-124-589-11	ELECT 47MF	20% 16V	C262	1-124-465-00	ELECT 0.47MF	20% 50V
C196	1-124-589-11	ELECT 47MF	20% 16V	C264	1-163-123-00	CERAMIC CHIP 180PF	5% 50V
C197	1-124-589-11	ELECT 47MF	20% 16V	C265	1-163-129-00	CERAMIC CHIP 330PF	5% 50V
C198	1-124-589-11	ELECT 47MF	20% 16V	C266	1-126-320-11	ELECT 10MF	20% 16V
C199	1-124-589-11	ELECT 47MF	20% 16V	C267	1-126-320-11	ELECT 10MF	20% 16V
C200	1-124-589-11	ELECT 47MF	20% 16V	C268	1-124-477-11	ELECT 47MF	20% 16V
C203	1-124-589-11	ELECT 47MF	20% 16V	C269	1-164-004-11	CERAMIC CHIP 0.1MF	10% 25V
C204	1-124-589-11	ELECT 47MF	20% 16V	C270	1-164-004-11	CERAMIC CHIP 0.1MF	10% 25V
C205	1-163-101-00	CERAMIC CHIP 22PF	5% 50V	C271	1-163-809-11	CERAMIC CHIP 0.047MF	10% 25V
C206	1-164-298-11	CERAMIC CHIP 0.15MF	10% 25V	C272	1-163-129-00	CERAMIC CHIP 330PF	5% 50V
C207	1-164-298-11	CERAMIC CHIP 0.15MF	10% 25V	C273	1-163-129-00	CERAMIC CHIP 330PF	5% 50V
C208	1-163-101-00	CERAMIC CHIP 22PF	5% 50V	C274	1-124-477-11	ELECT 47MF	20% 16V
C209	1-164-004-11	CERAMIC CHIP 0.1MF	10% 25V	C275	1-163-119-00	CERAMIC CHIP 120PF	5% 50V
C210	1-124-589-11	ELECT 47MF	20% 16V	C277	1-163-097-00	CERAMIC CHIP 15PF	5% 50V
C211	1-124-589-11	ELECT 47MF	20% 16V	C278	1-163-809-11	CERAMIC CHIP 0.047MF	10% 25V
C212	1-124-589-11	ELECT 47MF	20% 16V	C279	1-126-157-11	ELECT 10MF	20% 16V
C213	1-124-589-11	ELECT 47MF	20% 16V	C280	1-163-117-00	CERAMIC CHIP 100PF	5% 50V
C214	1-126-157-11	ELECT 10MF	20% 16V	C281	1-163-031-11	CERAMIC CHIP 0.01MF	50V
C215	1-126-157-11	ELECT 10MF	20% 16V	C282	1-163-031-11	CERAMIC CHIP 0.01MF	50V
C216	1-126-157-11	ELECT 10MF	20% 16V	C283	1-163-031-11	CERAMIC CHIP 0.01MF	50V
C217	1-163-031-11	CERAMIC CHIP 0.01MF	50V	C299	1-163-031-11	CERAMIC CHIP 0.01MF	50V
C218	1-164-298-11	CERAMIC CHIP 0.15MF	10% 25V	C300	1-126-157-11	ELECT 10MF	20% 16V
C219	1-163-009-11	CERAMIC CHIP 0.001MF	10% 50V	C301	1-163-809-11	CERAMIC CHIP 0.047MF	10% 25V
C220	1-163-031-11	CERAMIC CHIP 0.01MF	50V	C302	1-124-589-11	ELECT 47MF	20% 16V
C221	1-124-903-11	ELECT 1MF	20% 50V	C303	1-126-157-11	ELECT 10MF	20% 16V
C222	1-163-093-00	CERAMIC CHIP 10PF	5% 50V	C304	1-163-125-00	CERAMIC CHIP 220PF	5% 50V
C223	1-163-031-11	CERAMIC CHIP 0.01MF	50V	C305	1-124-257-00	ELECT 2.2MF	20% 50V
C225	1-124-477-11	ELECT 47MF	20% 16V	C306	1-163-115-00	CERAMIC CHIP 82PF	5% 50V
C226	1-163-031-11	CERAMIC CHIP 0.01MF	50V	C307	1-163-145-00	CERAMIC CHIP 0.0015MF	5% 50V
C227	1-163-038-00	CERAMIC CHIP 0.1MF	25V	C308	1-164-004-11	CERAMIC CHIP 0.1MF	10% 25V
C228	1-163-986-00	CERAMIC CHIP 0.027MF	10% 25V	C309	1-164-004-11	CERAMIC CHIP 0.1MF	10% 25V
C229	1-163-031-11	CERAMIC CHIP 0.01MF	50V	C310	1-164-004-11	CERAMIC CHIP 0.1MF	10% 25V
C230	1-163-038-00	CERAMIC CHIP 0.1MF	25V	C312	1-163-031-11	CERAMIC CHIP 0.01MF	50V
C231	1-163-986-00	CERAMIC CHIP 0.027MF	10% 25V	C313	1-163-115-00	CERAMIC CHIP 82PF	5% 50V
C232	1-163-031-11	CERAMIC CHIP 0.01MF	50V	C314	1-126-157-11	ELECT 10MF	20% 16V
C233	1-163-031-11	CERAMIC CHIP 0.01MF	50V	C315	1-164-299-11	CERAMIC CHIP 0.22MF	10% 25V
C234	1-163-038-00	CERAMIC CHIP 0.1MF	25V	C316	1-126-157-11	ELECT 10MF	20% 16V
C235	1-163-986-00	CERAMIC CHIP 0.027MF	10% 25V	C317	1-163-031-11	CERAMIC CHIP 0.01MF	50V
C236	1-163-031-11	CERAMIC CHIP 0.01MF	50V	C318	1-163-095-00	CERAMIC CHIP 12PF	5% 50V
C237	1-163-031-11	CERAMIC CHIP 0.01MF	50V	C319	1-163-095-00	CERAMIC CHIP 12PF	5% 50V
C238	1-164-299-11	CERAMIC CHIP 0.22MF	10% 25V	C320	1-163-095-00	CERAMIC CHIP 12PF	5% 50V
C239	1-163-809-11	CERAMIC CHIP 0.047MF	10% 25V	C321	1-163-121-00	CERAMIC CHIP 150PF	5% 50V
C240	1-163-809-11	CERAMIC CHIP 0.047MF	10% 25V	C322	1-163-121-00	CERAMIC CHIP 150PF	5% 50V
C241	1-163-809-11	CERAMIC CHIP 0.047MF	10% 25V	C324	1-163-121-00	CERAMIC CHIP 150PF	5% 50V
C242	1-163-113-00	CERAMIC CHIP 68PF	5% 50V	C340	1-163-205-00	CERAMIC CHIP 0.001MF	5% 50V
C243	1-163-031-11	CERAMIC CHIP 0.01MF	50V	C344	1-163-092-00	CERAMIC CHIP 9PF	0.25PF 50V
C244	1-163-103-00	CERAMIC CHIP 27PF	5% 50V	C345	1-163-109-00	CERAMIC CHIP 47PF	5% 50V
C245	1-163-105-00	CERAMIC CHIP 33PF	5% 50V	C346	1-163-109-00	CERAMIC CHIP 47PF	5% 50V
C246	1-163-809-11	CERAMIC CHIP 0.047MF	10% 25V	C347	1-163-109-00	CERAMIC CHIP 47PF	5% 50V
C247	1-163-809-11	CERAMIC CHIP 0.047MF	10% 25V	C1293	1-163-119-00	CERAMIC CHIP 120PF	5% 50V
C248	1-163-809-11	CERAMIC CHIP 0.047MF	10% 25V	C1294	1-163-119-00	CERAMIC CHIP 120PF	5% 50V
C249	1-126-101-11	ELECT 100MF	20% 16V	C1295	1-163-119-00	CERAMIC CHIP 120PF	5% 50V
C250	1-163-017-00	CERAMIC CHIP 0.0047MF	10% 50V	C1296	1-163-115-00	CERAMIC CHIP 82PF	5% 50V
C251	1-110-364-11	MYLAR 0.1MF	10% 200V	C1297	1-163-103-00	CERAMIC CHIP 27PF	5% 50V
C252	1-123-935-00	ELECT 33MF	20% 160V	C1298	1-163-113-00	CERAMIC CHIP 68PF	5% 50V
C253	1-124-477-11	ELECT 47MF	20% 16V	C1299	1-163-093-00	CERAMIC CHIP 10PF	5% 50V
C254	1-163-031-11	CERAMIC CHIP 0.01MF	50V	C1300	1-126-160-11	ELECT 1MF	20% 50V
C255	1-124-477-11	ELECT 47MF	20% 16V	C1301	1-126-160-11	ELECT 1MF	20% 50V
C256	1-163-129-00	CERAMIC CHIP 330PF	5% 50V	C1302	1-126-160-11	ELECT 1MF	20% 50V
C257	1-163-129-00	CERAMIC CHIP 330PF	5% 50V				
C258	1-163-129-00	CERAMIC CHIP 330PF	5% 50V				

B

REF.NO.	PART NO.	DESCRIPTION	REMARK	REF.NO.	PART NO.	DESCRIPTION	REMARK
C1303	1-126-160-11	ELECT 1MF 20% 50V		D135	8-719-404-46	DIODE MA110	
		<FILTER BLOCK>		D136	8-719-404-46	DIODE MA110	
CFM101	1-464-880-11	FILTER BLOCK, COM (CFB-2)		D137	8-719-404-46	DIODE MA110	
		<CONNECTOR>		D138	8-719-404-46	DIODE MA110	
CN101	1-506-480-11	PIN, CONNECTOR 15P		D139	8-719-404-46	DIODE MA110	
CN102	*1-564-506-11	PLUG, CONNECTOR 3P		D142	8-719-404-46	DIODE MA110	
CN103	*1-565-503-11	CONNECTOR, BOARD TO BOARD 12P		D143	8-719-404-46	DIODE MA110	
CN104	1-506-477-11	PIN, CONNECTOR 12P		D144	8-719-404-46	DIODE MA110	
CN105	*1-564-509-11	PLUG, CONNECTOR 6P		D145	8-719-404-46	DIODE MA110	
CN106	1-506-473-11	PIN, CONNECTOR 8P		D146	8-719-404-46	DIODE MA110	
CN107	1-506-478-11	PIN, CONNECTOR 13P		D147	8-719-404-46	DIODE MA110	
CN108	*1-564-506-11	PLUG, CONNECTOR 3P		D148	8-719-404-46	DIODE MA110	
		<TRAP MODULE>		D149	8-719-404-46	DIODE MA110	
CTR101	1-236-366-11	MODULE, TRAP		D150	8-719-404-46	DIODE MA110	
CTR102	1-236-365-11	MODULE, TRAP		D151	8-719-404-46	DIODE MA110	
		<TRIMMER>		D152	8-719-404-46	DIODE MA110	
CV101	1-141-245-00	CAP, TRIMMER		D153	8-719-977-20	DIODE DT28.2B	
CV102	1-141-245-00	CAP, TRIMMER		D154	8-719-404-46	DIODE MA110	
		<DIODE>		D155	8-719-404-46	DIODE MA110	
D101	8-719-404-46	DIODE MA110		D156	8-719-404-46	DIODE MA110	
D102	8-719-404-46	DIODE MA110		D157	8-719-901-83	DIODE 1SS83	
D103	8-719-404-46	DIODE MA110		D158	8-719-901-83	DIODE 1SS83	
D104	8-719-404-46	DIODE MA110		D159	8-719-901-83	DIODE 1SS83	
D105	8-719-404-46	DIODE MA110		D160	8-719-404-46	DIODE MA110	
D106	8-719-404-46	DIODE MA110		D161	8-719-404-46	DIODE MA110	
D107	8-719-404-46	DIODE MA110		D162	8-719-404-46	DIODE MA110	
D108	8-719-404-46	DIODE MA110		D170	8-719-404-46	DIODE MA110	
D109	8-719-404-46	DIODE MA110		D171	8-719-404-46	DIODE MA110	
D110	8-719-404-46	DIODE MA110		D172	8-719-404-46	DIODE MA110	
D111	8-719-404-46	DIODE MA110		D285	8-719-404-46	DIODE MA110	
D112	8-719-404-46	DIODE MA110		D289	8-719-404-46	DIODE MA110	
D113	8-719-404-46	DIODE MA110		D341	8-719-404-46	DIODE MA110	
D114	8-719-404-46	DIODE MA110		D342	8-719-104-34	DIODE 1S2836	
D115	8-719-404-46	DIODE MA110		D343	8-719-800-76	DIODE 1SS226	
D116	8-719-404-46	DIODE MA110		D344	8-719-105-XX	DIODE RD6.2M-B1	
D117	8-719-404-46	DIODE MA110		D345	8-719-901-83	DIODE 1SS83	
D118	8-719-404-46	DIODE MA110		D346	8-719-901-83	DIODE 1SS83	
D119	8-719-404-46	DIODE MA110		D347	8-719-901-83	DIODE 1SS83	
D120	8-719-404-46	DIODE MA110		D348	8-719-800-76	DIODE 1SS226	
D121	8-719-404-46	DIODE MA110		D349	8-719-800-76	DIODE 1SS226	
D122	8-719-404-46	DIODE MA110		D350	8-719-800-76	DIODE 1SS226	
D123	8-719-404-46	DIODE MA110		D393	8-719-404-46	DIODE MA110	
D125	8-719-404-46	DIODE MA110				<DELAY LINE>	
D126	8-719-404-46	DIODE MA110		DL101	1-415-632-11	DELAY LINE, Y	
D127	8-719-404-46	DIODE MA110		DL102	1-415-633-11	DELAY LINE, Y	
D128	8-719-400-18	DIODE MA152WK				<IC>	
D129	8-719-404-46	DIODE MA110		IC101	8-759-048-09	IC MM1148XF	
D130	8-719-800-76	DIODE 1SS226		IC102	8-759-501-21	IC MM1149XF	
D131	8-719-800-76	DIODE 1SS226		IC103	8-759-501-21	IC MM1149XF	
D132	8-719-800-76	DIODE 1SS226		IC104	8-759-501-21	IC MM1149XF	
D133	8-719-404-46	DIODE MA110		IC105	8-759-048-09	IC MM1148XF	
D134	8-719-404-46	DIODE MA110		IC106	8-759-009-51	IC NC14538BF	
				IC107	8-759-509-57	IC XRU4584BF	
				IC108	8-759-509-17	IC XRU4053BF	
				IC109	8-759-509-37	IC XRU4070BF	
				IC110	8-759-509-17	IC XRU4053BF	
				IC111	8-759-509-17	IC XRU4053BF	
				IC112	8-759-924-12	IC LM7805CT	

B

REF.NO.	PART NO.	DESCRIPTION	REMARK	REF.NO.	PART NO.	DESCRIPTION	REMARK
IC113	8-759-631-08	IC M51279FP		Q123	8-729-920-74	TRANSISTOR 2SC2412K-QR	
IC114	8-759-509-13	IC XRU4052BF		Q124	8-729-216-22	TRANSISTOR 2SA1162-G	
IC115	8-759-509-13	IC XRU4052BF		Q125	8-729-920-74	TRANSISTOR 2SC2412K-QR	
IC116	8-759-509-05	IC XRU4066BF		Q126	8-729-901-01	TRANSISTOR DTC144EK	
IC117	8-759-711-32	IC NJM2245M		Q127	8-729-216-22	TRANSISTOR 2SA1162-G	
IC118	8-759-711-32	IC NJM2245M		Q128	8-729-216-22	TRANSISTOR 2SA1162-G	
IC119	8-759-711-32	IC NJM2245M		Q129	8-729-901-01	TRANSISTOR DTC144EK	
IC120	8-759-509-05	IC XRU4066BF		Q130	8-729-216-22	TRANSISTOR 2SA1162-G	
IC121	8-759-509-17	IC XRU4053BF		Q131	8-729-920-74	TRANSISTOR 2SC2412K-QR	
IC122	8-759-998-98	IC LM358D		Q132	8-729-216-22	TRANSISTOR 2SA1162-G	
IC123	8-759-998-98	IC LM358D		Q133	8-729-920-74	TRANSISTOR 2SC2412K-QR	
IC124	8-752-052-62	IC CXA1478S		Q134	8-729-901-01	TRANSISTOR DTC144EK	
IC125	8-759-509-05	IC XRU4066BF		Q135	8-729-920-74	TRANSISTOR 2SC2412K-QR	
IC126	8-759-509-17	IC XRU4053BF		Q136	8-729-907-26	TRANSISTOR 1MX1	
IC127	8-759-998-98	IC LM358D		Q137	8-729-907-26	TRANSISTOR 1MX1	
IC128	8-759-998-98	IC LM358D		Q138	8-729-907-26	TRANSISTOR 1MX1	
IC129	8-759-998-98	IC LM358D		Q139	8-729-216-22	TRANSISTOR 2SA1162-G	
<COIL>				Q140	8-729-920-74	TRANSISTOR 2SC2412K-QR	
L101	1-410-470-11	INDUCTOR 10UH		Q141	8-729-920-74	TRANSISTOR 2SC2412K-QR	
L102	1-410-090-41	INDUCTOR 18MMH		Q142	8-729-920-74	TRANSISTOR 2SC2412K-QR	
L103	1-412-002-31	INDUCTOR CHIP 4.7UH		Q143	8-729-920-74	TRANSISTOR 2SC2412K-QR	
L104	1-412-002-31	INDUCTOR CHIP 4.7UH		Q144	8-729-920-74	TRANSISTOR 2SC2412K-QR	
L105	1-412-002-31	INDUCTOR CHIP 4.7UH		Q145	8-729-920-74	TRANSISTOR 2SC2412K-QR	
L106	1-410-470-11	INDUCTOR 10UH		Q146	8-729-255-12	TRANSISTOR 2SC2551-0	
L107	1-410-470-11	INDUCTOR 10UH		Q147	8-729-255-12	TRANSISTOR 2SC2551-0	
L108	1-408-418-00	INDUCTOR 56UH		Q148	8-729-216-22	TRANSISTOR 2SA1162-G	
L109	1-408-418-00	INDUCTOR 56UH		Q149	8-729-200-17	TRANSISTOR 2SA1091-02	
L110	1-408-418-00	INDUCTOR 56UH		Q150	8-729-920-74	TRANSISTOR 2SC2412K-QR	
L112	1-408-419-00	INDUCTOR 68UH		Q151	8-729-216-22	TRANSISTOR 2SA1162-G	
L113	1-410-947-31	INDUCTOR CHIP 33UH		Q152	8-729-200-17	TRANSISTOR 2SA1091-02	
L114	1-410-947-31	INDUCTOR CHIP 33UH		Q153	8-729-920-74	TRANSISTOR 2SC2412K-QR	
L115	1-410-947-31	INDUCTOR CHIP 33UH		Q154	8-729-216-22	TRANSISTOR 2SA1162-G	
L116	1-412-011-31	INDUCTOR CHIP 27UH		Q155	8-729-200-17	TRANSISTOR 2SA1091-02	
L117	1-412-011-31	INDUCTOR CHIP 27UH		Q157	8-729-326-11	TRANSISTOR 2SC2611	
L118	1-412-011-31	INDUCTOR CHIP 27UH		Q158	8-729-326-11	TRANSISTOR 2SC2611	
L250	1-410-997-31	INDUCTOR CHIP 2.2UH		Q159	8-729-326-11	TRANSISTOR 2SC2611	
L251	1-410-999-11	INDUCTOR CHIP 3.3UH		Q160	8-729-920-74	TRANSISTOR 2SC2412K-QR	
L252	1-410-478-11	INDUCTOR 47UH		Q161	8-729-216-22	TRANSISTOR 2SA1162-G	
L300	1-410-482-31	INDUCTOR 100UH		Q162	8-729-920-74	TRANSISTOR 2SC2412K-QR	
<TRANSISTOR>				Q163	8-729-920-74	TRANSISTOR 2SC2412K-QR	
Q101	8-729-920-74	TRANSISTOR 2SC2412K-QR		Q164	8-729-901-01	TRANSISTOR DTC144EK	
Q102	8-729-920-74	TRANSISTOR 2SC2412K-QR		Q165	8-729-216-22	TRANSISTOR 2SA1162-G	
Q103	8-729-920-74	TRANSISTOR 2SC2412K-QR		Q166	8-729-216-22	TRANSISTOR 2SA1162-G	
Q104	8-729-920-74	TRANSISTOR 2SC2412K-QR		Q167	8-729-216-22	TRANSISTOR 2SA1162-G	
Q105	8-729-920-74	TRANSISTOR 2SC2412K-QR		Q168	8-729-216-22	TRANSISTOR 2SA1162-G	
Q106	8-729-920-74	TRANSISTOR 2SC2412K-QR		Q170	8-729-920-74	TRANSISTOR 2SC2412K-QR	
Q107	8-729-920-74	TRANSISTOR 2SC2412K-QR		Q171	8-729-920-74	TRANSISTOR 2SC2412K-QR	
Q108	8-729-216-22	TRANSISTOR 2SA1162-G		Q172	8-729-920-74	TRANSISTOR 2SC2412K-QR	
Q109	8-729-901-01	TRANSISTOR DTC144EK		Q173	8-729-216-22	TRANSISTOR 2SA1162-G	
Q112	8-729-920-74	TRANSISTOR 2SC2412K-QR		Q174	8-729-216-22	TRANSISTOR 2SA1162-G	
Q113	8-729-920-74	TRANSISTOR 2SC2412K-QR		Q175	8-729-216-22	TRANSISTOR 2SA1162-G	
Q114	8-729-216-22	TRANSISTOR 2SA1162-G		Q176	8-729-216-22	TRANSISTOR 2SA1162-G	
Q115	8-729-920-74	TRANSISTOR 2SC2412K-QR		Q177	8-729-920-74	TRANSISTOR 2SC2412K-QR	
Q116	8-729-920-74	TRANSISTOR 2SC2412K-QR		Q178	8-729-920-74	TRANSISTOR 2SC2412K-QR	
Q117	8-729-216-22	TRANSISTOR 2SA1162-G		Q179	8-729-901-01	TRANSISTOR DTC144EK	
Q118	8-729-920-74	TRANSISTOR 2SC2412K-QR		Q190	8-729-216-22	TRANSISTOR 2SA1162-G	
Q119	8-729-216-22	TRANSISTOR 2SA1162-G		Q191	8-729-920-74	TRANSISTOR 2SC2412K-QR	
Q120	8-729-216-22	TRANSISTOR 2SA1162-G		Q192	8-729-920-74	TRANSISTOR 2SC2412K-QR	
Q121	8-729-920-74	TRANSISTOR 2SC2412K-QR		Q193	8-729-920-74	TRANSISTOR 2SC2412K-QR	
Q122	8-729-216-22	TRANSISTOR 2SA1162-G		Q194	8-729-920-74	TRANSISTOR 2SC2412K-QR	
				Q195	8-729-216-22	TRANSISTOR 2SA1162-G	
				Q196	8-729-920-74	TRANSISTOR 2SC2412K-QR	
				Q197	8-729-216-22	TRANSISTOR 2SA1162-G	

B

REF. NO.	PART NO.	DESCRIPTION	REMARK	REF. NO.	PART NO.	DESCRIPTION	REMARK
Q198	8-729-216-22	TRANSISTOR 2SA1162-G		R141	1-216-063-00	METAL GLAZE 3.9K 5%	1/10W
Q199	8-729-216-22	TRANSISTOR 2SA1162-G		R142	1-216-073-00	METAL GLAZE 10K 5%	1/10W
Q200	8-729-901-06	TRANSISTOR DTA144EK		R143	1-216-085-00	METAL GLAZE 33K 5%	1/10W
Q201	8-729-216-22	TRANSISTOR 2SA1162-G		R145	1-216-065-00	METAL GLAZE 4.7K 5%	1/10W
Q202	8-729-216-22	TRANSISTOR 2SA1162-G		R146	1-216-037-00	METAL GLAZE 330 5%	1/10W
Q203	8-729-216-22	TRANSISTOR 2SA1162-G		R147	1-216-089-00	METAL GLAZE 47K 5%	1/10W
Q204	8-729-216-22	TRANSISTOR 2SA1162-G		R148	1-216-671-11	METAL CHIP 6.8K 0.50%	1/10W
Q205	8-729-216-22	TRANSISTOR 2SA1162-G		R155	1-216-655-11	METAL CHIP 1.5K 0.50%	1/10W
Q206	8-729-216-22	TRANSISTOR 2SA1162-G		R157	1-216-679-11	METAL CHIP 15K 0.50%	1/10W
Q208	8-729-216-22	TRANSISTOR 2SA1162-G		R158	1-216-677-11	METAL CHIP 12K 0.50%	1/10W
Q209	8-729-255-12	TRANSISTOR 2SC2551-0		R160	1-216-065-00	METAL GLAZE 4.7K 5%	1/10W
Q210	8-729-255-12	TRANSISTOR 2SC2551-0		R161	1-216-089-00	METAL GLAZE 47K 5%	1/10W
Q211	8-729-255-12	TRANSISTOR 2SC2551-0		R163	1-216-073-00	METAL GLAZE 10K 5%	1/10W
Q212	8-729-109-44	TRANSISTOR 2SK94-X4		R164	1-216-677-11	METAL CHIP 12K 0.50%	1/10W
Q299	8-729-920-74	TRANSISTOR 2SC2412K-QR		R165	1-216-107-00	METAL GLAZE 270K 5%	1/10W
<RESISTOR>				R166	1-216-681-11	METAL CHIP 18K 0.50%	1/10W
JR105	1-216-295-00	METAL GLAZE 0 5%	1/10W	R167	1-216-635-11	METAL CHIP 220 0.50%	1/10W
JR110	1-216-295-00	METAL GLAZE 0 5%	1/10W	R168	1-216-103-00	METAL GLAZE 180K 5%	1/10W
JR118	1-216-295-00	METAL GLAZE 0 5%	1/10W	R169	1-216-033-00	METAL GLAZE 220 5%	1/10W
JR133	1-216-295-00	METAL GLAZE 0 5%	1/10W	R170	1-216-089-00	METAL GLAZE 47K 5%	1/10W
JR138	1-216-295-00	METAL GLAZE 0 5%	1/10W	R171	1-216-053-00	METAL GLAZE 1.5K 5%	1/10W
JR178	1-216-295-00	METAL GLAZE 0 5%	1/10W	R172	1-216-043-00	METAL GLAZE 560 5%	1/10W
R101	1-216-089-00	METAL GLAZE 47K 5%	1/10W	R173	1-216-093-00	METAL GLAZE 68K 5%	1/10W
R102	1-216-025-00	METAL GLAZE 100 5%	1/10W	R174	1-216-069-00	METAL GLAZE 6.8K 5%	1/10W
R103	1-216-091-00	METAL GLAZE 56K 5%	1/10W	R175	1-216-057-00	METAL GLAZE 2.2K 5%	1/10W
R104	1-216-061-00	METAL GLAZE 3.3K 5%	1/10W	R176	1-216-065-00	METAL GLAZE 4.7K 5%	1/10W
R105	1-216-025-00	METAL GLAZE 100 5%	1/10W	R177	1-216-073-00	METAL GLAZE 10K 5%	1/10W
R106	1-216-065-00	METAL GLAZE 4.7K 5%	1/10W	R178	1-216-089-00	METAL GLAZE 47K 5%	1/10W
R107	1-216-025-00	METAL GLAZE 100 5%	1/10W	R179	1-216-081-00	METAL GLAZE 22K 5%	1/10W
R108	1-216-113-00	METAL GLAZE 470K 5%	1/10W	R180	1-216-679-11	METAL CHIP 15K 0.50%	1/10W
R109	1-216-065-00	METAL GLAZE 4.7K 5%	1/10W	R181	1-216-071-00	METAL GLAZE 8.2K 5%	1/10W
R110	1-216-049-00	METAL GLAZE 1K 5%	1/10W	R182	1-216-683-11	METAL CHIP 22K 0.50%	1/10W
R111	1-216-063-00	METAL GLAZE 3.9K 5%	1/10W	R183	1-216-691-11	METAL CHIP 47K 0.50%	1/10W
R112	1-216-049-00	METAL GLAZE 1K 5%	1/10W	R184	1-216-699-11	METAL CHIP 100K 0.50%	1/10W
R113	1-249-401-11	CARBON 47 5%	1/4W F	R185	1-216-073-00	METAL GLAZE 10K 5%	1/10W
R114	1-216-045-00	METAL GLAZE 680 5%	1/10W	R186	1-216-113-00	METAL GLAZE 470K 5%	1/10W
R115	1-216-061-00	METAL GLAZE 3.3K 5%	1/10W	R187	1-216-073-00	METAL GLAZE 10K 5%	1/10W
R117	1-216-073-00	METAL GLAZE 10K 5%	1/10W	R188	1-216-113-00	METAL GLAZE 470K 5%	1/10W
R118	1-216-025-00	METAL GLAZE 100 5%	1/10W	R189	1-216-103-00	METAL GLAZE 180K 5%	1/10W
R119	1-216-647-11	METAL CHIP 680 0.50%	1/10W	R190	1-216-107-00	METAL GLAZE 270K 5%	1/10W
R120	1-216-647-11	METAL CHIP 680 0.50%	1/10W	R191	1-216-097-00	METAL GLAZE 100K 5%	1/10W
R121	1-216-025-00	METAL GLAZE 100 5%	1/10W	R192	1-216-103-00	METAL GLAZE 180K 5%	1/10W
R122	1-216-083-00	METAL GLAZE 27K 5%	1/10W	R193	1-216-105-00	METAL GLAZE 220K 5%	1/10W
R123	1-216-073-00	METAL GLAZE 10K 5%	1/10W	R194	1-216-089-00	METAL GLAZE 47K 5%	1/10W
R124	1-216-073-00	METAL GLAZE 10K 5%	1/10W	R195	1-216-113-00	METAL GLAZE 470K 5%	1/10W
R125	1-216-083-00	METAL GLAZE 27K 5%	1/10W	R196	1-216-073-00	METAL GLAZE 10K 5%	1/10W
R126	1-216-093-00	METAL GLAZE 68K 5%	1/10W	R197	1-216-671-11	METAL CHIP 6.8K 0.50%	1/10W
R127	1-216-037-00	METAL GLAZE 330 5%	1/10W	R198	1-216-049-00	METAL GLAZE 1K 5%	1/10W
R128	1-216-083-00	METAL GLAZE 27K 5%	1/10W	R199	1-216-065-00	METAL GLAZE 4.7K 5%	1/10W
R129	1-216-067-00	METAL GLAZE 5.6K 5%	1/10W	R200	1-216-065-00	METAL GLAZE 4.7K 5%	1/10W
R130	1-216-097-00	METAL GLAZE 100K 5%	1/10W	R201	1-216-043-00	METAL GLAZE 560 5%	1/10W
R131	1-216-089-00	METAL GLAZE 47K 5%	1/10W	R202	1-216-033-00	METAL GLAZE 220 5%	1/10W
R132	1-216-057-00	METAL GLAZE 2.2K 5%	1/10W	R203	1-216-045-00	METAL GLAZE 680 5%	1/10W
R133	1-216-079-00	METAL GLAZE 18K 5%	1/10W	R204	1-216-073-00	METAL GLAZE 10K 5%	1/10W
R134	1-216-645-11	METAL CHIP 560 0.50%	1/10W	R205	1-216-073-00	METAL GLAZE 10K 5%	1/10W
R135	1-216-645-11	METAL CHIP 560 0.50%	1/10W	R206	1-216-043-00	METAL GLAZE 560 5%	1/10W
R136	1-216-091-00	METAL GLAZE 56K 5%	1/10W	R207	1-216-045-00	METAL GLAZE 680 5%	1/10W
R137	1-216-045-00	METAL GLAZE 680 5%	1/10W	R208	1-216-671-11	METAL CHIP 6.8K 0.50%	1/10W
R138	1-216-657-11	METAL CHIP 1.8K 0.50%	1/10W	R209	1-216-043-00	METAL GLAZE 560 5%	1/10W
R139	1-216-079-00	METAL GLAZE 18K 5%	1/10W	R210	1-216-033-00	METAL GLAZE 220 5%	1/10W
R140	1-216-653-11	METAL CHIP 1.2K 0.50%	1/10W	R211	1-216-099-00	METAL GLAZE 120K 5%	1/10W
				R212	1-216-065-00	METAL GLAZE 4.7K 5%	1/10W
				R213	1-216-043-00	METAL GLAZE 560 5%	1/10W

B

REF. NO.	PART NO.	DESCRIPTION	REMARK	REF. NO.	PART NO.	DESCRIPTION	REMARK
R214	1-216-043-00	METAL GLAZE	560 5% 1/10W	R280	1-216-061-00	METAL GLAZE	3.3K 5% 1/10W
R215	1-216-125-00	METAL GLAZE	1.5M 5% 1/10W	R281	1-216-061-00	METAL GLAZE	3.3K 5% 1/10W
R216	1-216-043-00	METAL GLAZE	560 5% 1/10W	R282	1-216-037-00	METAL GLAZE	330 5% 1/10W
R217	1-216-033-00	METAL GLAZE	220 5% 1/10W	R283	1-216-049-00	METAL GLAZE	1K 5% 1/10W
R218	1-216-295-00	METAL GLAZE	0 5% 1/10W	R284	1-216-057-00	METAL GLAZE	2.2K 5% 1/10W
R219	1-216-043-00	METAL GLAZE	560 5% 1/10W	R285	1-216-037-00	METAL GLAZE	330 5% 1/10W
R220	1-216-043-00	METAL GLAZE	560 5% 1/10W	R286	1-216-061-00	METAL GLAZE	3.3K 5% 1/10W
R221	1-216-035-00	METAL GLAZE	270 5% 1/10W	R287	1-216-061-00	METAL GLAZE	3.3K 5% 1/10W
R222	1-216-033-00	METAL GLAZE	220 5% 1/10W	R288	1-216-037-00	METAL GLAZE	330 5% 1/10W
R223	1-216-073-00	METAL GLAZE	10K 5% 1/10W	R289	1-216-049-00	METAL GLAZE	1K 5% 1/10W
R224	1-216-073-00	METAL GLAZE	10K 5% 1/10W	R290	1-216-057-00	METAL GLAZE	2.2K 5% 1/10W
R225	1-216-095-00	METAL GLAZE	82K 5% 1/10W	R291	1-216-037-00	METAL GLAZE	330 5% 1/10W
R226	1-216-073-00	METAL GLAZE	10K 5% 1/10W	R292	1-216-061-00	METAL GLAZE	3.3K 5% 1/10W
R227	1-216-035-00	METAL GLAZE	270 5% 1/10W	R293	1-216-061-00	METAL GLAZE	3.3K 5% 1/10W
R228	1-216-065-00	METAL GLAZE	4.7K 5% 1/10W	R295	1-216-057-00	METAL GLAZE	2.2K 5% 1/10W
R229	1-216-113-00	METAL GLAZE	470K 5% 1/10W	R296	1-216-659-11	METAL CHIP	2.2K 0.50% 1/10W
R230	1-216-081-00	METAL GLAZE	22K 5% 1/10W	R297	1-216-659-11	METAL CHIP	2.2K 0.50% 1/10W
R231	1-216-113-00	METAL GLAZE	470K 5% 1/10W	R298	1-216-065-00	METAL GLAZE	4.7K 5% 1/10W
R232	1-216-105-00	METAL GLAZE	220K 5% 1/10W	R300	1-216-065-00	METAL GLAZE	4.7K 5% 1/10W
R233	1-216-073-00	METAL GLAZE	10K 5% 1/10W	R301	1-216-065-00	METAL GLAZE	4.7K 5% 1/10W
R234	1-216-041-00	METAL GLAZE	470 5% 1/10W	R302	1-216-113-00	METAL GLAZE	470K 5% 1/10W
R235	1-216-041-00	METAL GLAZE	470 5% 1/10W	R303	1-216-065-00	METAL GLAZE	4.7K 5% 1/10W
R236	1-216-077-00	METAL GLAZE	15K 5% 1/10W	R304	1-216-049-00	METAL GLAZE	1K 5% 1/10W
R237	1-216-025-00	METAL GLAZE	100 5% 1/10W	R305	1-216-049-00	METAL GLAZE	1K 5% 1/10W
R238	1-216-065-00	METAL GLAZE	4.7K 5% 1/10W	R306	1-216-089-00	METAL GLAZE	47K 5% 1/10W
R239	1-216-065-00	METAL GLAZE	4.7K 5% 1/10W	R307	1-216-033-00	METAL GLAZE	220 5% 1/10W
R240	1-216-033-00	METAL GLAZE	220 5% 1/10W	R308	1-216-089-00	METAL GLAZE	47K 5% 1/10W
R241	1-216-073-00	METAL GLAZE	10K 5% 1/10W	R309	1-216-089-00	METAL GLAZE	47K 5% 1/10W
R242	1-216-051-00	METAL GLAZE	1.2K 5% 1/10W	R310	1-216-033-00	METAL GLAZE	220 5% 1/10W
R243	1-216-113-00	METAL GLAZE	470K 5% 1/10W	R311	1-216-089-00	METAL GLAZE	47K 5% 1/10W
R244	1-216-065-00	METAL GLAZE	4.7K 5% 1/10W	R312	1-216-089-00	METAL GLAZE	47K 5% 1/10W
R245	1-216-679-11	METAL CHIP	15K 0.50% 1/10W	R313	1-216-033-00	METAL GLAZE	220 5% 1/10W
R246	1-216-103-00	METAL GLAZE	180K 5% 1/10W	R314	1-216-089-00	METAL GLAZE	47K 5% 1/10W
R247	1-216-093-00	METAL GLAZE	68K 5% 1/10W	R315	1-216-113-00	METAL GLAZE	470K 5% 1/10W
R248	1-216-095-00	METAL GLAZE	82K 5% 1/10W	R316	1-216-105-00	METAL GLAZE	220K 5% 1/10W
R249	1-216-109-00	METAL GLAZE	330K 5% 1/10W	R317	1-216-109-00	METAL GLAZE	330K 5% 1/10W
R250	1-216-101-00	METAL GLAZE	150K 5% 1/10W	R318	1-216-105-00	METAL GLAZE	220K 5% 1/10W
R251	1-216-105-00	METAL GLAZE	220K 5% 1/10W	R319	1-216-099-00	METAL GLAZE	120K 5% 1/10W
R252	1-216-101-00	METAL GLAZE	150K 5% 1/10W	R320	1-216-099-00	METAL GLAZE	120K 5% 1/10W
R253	1-216-101-00	METAL GLAZE	150K 5% 1/10W	R321	1-216-043-00	METAL GLAZE	560 5% 1/10W
R254	1-216-033-00	METAL GLAZE	220 5% 1/10W	R322	1-216-109-00	METAL GLAZE	330K 5% 1/10W
R255	1-216-061-00	METAL GLAZE	3.3K 5% 1/10W	R323	1-216-109-00	METAL GLAZE	330K 5% 1/10W
R256	1-216-107-00	METAL GLAZE	270K 5% 1/10W	R324	1-216-109-00	METAL GLAZE	330K 5% 1/10W
R258	1-216-041-00	METAL GLAZE	470 5% 1/10W	R325	1-216-097-00	METAL GLAZE	100K 5% 1/10W
R259	1-216-073-00	METAL GLAZE	10K 5% 1/10W	R326	1-216-113-00	METAL GLAZE	470K 5% 1/10W
R260	1-216-025-00	METAL GLAZE	100 5% 1/10W	R328	1-216-073-00	METAL GLAZE	10K 5% 1/10W
R261	1-216-035-00	METAL GLAZE	270 5% 1/10W	R329	1-216-107-00	METAL GLAZE	270K 5% 1/10W
R262	1-216-097-00	METAL GLAZE	100K 5% 1/10W	R330	1-216-105-00	METAL GLAZE	220K 5% 1/10W
R263	1-216-029-00	METAL GLAZE	150 5% 1/10W	R331	1-216-025-00	METAL GLAZE	100 5% 1/10W
R264	1-216-065-00	METAL GLAZE	4.7K 5% 1/10W	R332	1-216-097-00	METAL GLAZE	100K 5% 1/10W
R265	1-216-067-00	METAL GLAZE	5.6K 5% 1/10W	R333	1-216-097-00	METAL GLAZE	100K 5% 1/10W
R266	1-216-073-00	METAL GLAZE	10K 5% 1/10W	R334	1-216-025-00	METAL GLAZE	100 5% 1/10W
R267	1-216-073-00	METAL GLAZE	10K 5% 1/10W	R335	1-216-099-00	METAL GLAZE	120K 5% 1/10W
R268	1-216-081-00	METAL GLAZE	22K 5% 1/10W	R336	1-216-095-00	METAL GLAZE	82K 5% 1/10W
R269	1-216-101-00	METAL GLAZE	150K 5% 1/10W	R337	1-216-105-00	METAL GLAZE	220K 5% 1/10W
R270	1-216-081-00	METAL GLAZE	22K 5% 1/10W	R338	1-216-025-00	METAL GLAZE	100 5% 1/10W
R271	1-216-025-00	METAL GLAZE	100 5% 1/10W	R339	1-216-099-00	METAL GLAZE	120K 5% 1/10W
R272	1-216-101-00	METAL GLAZE	150K 5% 1/10W	R340	1-216-095-00	METAL GLAZE	82K 5% 1/10W
R273	1-216-113-00	METAL GLAZE	470K 5% 1/10W	R341	1-216-105-00	METAL GLAZE	220K 5% 1/10W
R275	1-216-081-00	METAL GLAZE	22K 5% 1/10W	R342	1-216-047-00	METAL GLAZE	820 5% 1/10W
R276	1-216-037-00	METAL GLAZE	330 5% 1/10W	R343	1-216-053-00	METAL GLAZE	1.5K 5% 1/10W
R277	1-216-049-00	METAL GLAZE	1K 5% 1/10W				
R278	1-216-057-00	METAL GLAZE	2.2K 5% 1/10W				
R279	1-216-037-00	METAL GLAZE	330 5% 1/10W				

B

REF. NO.	PART NO.	DESCRIPTION	REMARK	REF. NO.	PART NO.	DESCRIPTION	REMARK
R344	1-216-664-11	METAL CHIP	3.6K 0.50% 1/10W	R1017	1-216-045-00	METAL GLAZE	680 5% 1/10W
R345	1-216-661-11	METAL CHIP	2.7K 0.50% 1/10W	R1018	1-216-043-00	METAL GLAZE	560 5% 1/10W
R346	1-216-105-00	METAL GLAZE	220K 5% 1/10W	R1019	1-216-033-00	METAL GLAZE	220 5% 1/10W
R348	1-216-061-00	METAL GLAZE	3.3K 5% 1/10W	R1020	1-216-089-00	METAL GLAZE	47K 5% 1/10W
R349	1-216-650-11	METAL CHIP	910 0.50% 1/10W	R1021	1-216-045-00	METAL GLAZE	680 5% 1/10W
R350	1-216-653-11	METAL CHIP	1.2K 0.50% 1/10W	R1022	1-216-025-00	METAL GLAZE	100 5% 1/10W
R351	1-216-650-11	METAL CHIP	910 0.50% 1/10W	R1023	1-216-073-00	METAL GLAZE	10K 5% 1/10W
R352	1-216-653-11	METAL CHIP	1.2K 0.50% 1/10W	R1024	1-216-025-00	METAL GLAZE	100 5% 1/10W
R353	1-216-650-11	METAL CHIP	910 0.50% 1/10W	R1025	1-216-033-00	METAL GLAZE	220 5% 1/10W
R354	1-216-653-11	METAL CHIP	1.2K 0.50% 1/10W	R1026	1-216-061-00	METAL GLAZE	3.3K 5% 1/10W
R355	1-216-113-00	METAL GLAZE	470K 5% 1/10W	R1027	1-216-101-00	METAL GLAZE	150K 5% 1/10W
R356	1-216-113-00	METAL GLAZE	470K 5% 1/10W	R1028	1-216-033-00	METAL GLAZE	220 5% 1/10W
R357	1-216-095-00	METAL GLAZE	82K 5% 1/10W	R1029	1-216-061-00	METAL GLAZE	3.3K 5% 1/10W
R358	1-216-113-00	METAL GLAZE	470K 5% 1/10W	R1030	1-216-089-00	METAL GLAZE	47K 5% 1/10W
R359	1-216-081-00	METAL GLAZE	22K 5% 1/10W	R1031	1-216-033-00	METAL GLAZE	220 5% 1/10W
R360	1-216-089-00	METAL GLAZE	47K 5% 1/10W	R1032	1-216-061-00	METAL GLAZE	3.3K 5% 1/10W
R363	1-216-069-00	METAL GLAZE	6.8K 5% 1/10W	R1033	1-216-081-00	METAL GLAZE	22K 5% 1/10W
R364	1-216-073-00	METAL GLAZE	10K 5% 1/10W	R1035	1-216-073-00	METAL GLAZE	10K 5% 1/10W
R365	1-216-073-00	METAL GLAZE	10K 5% 1/10W	R1036	1-216-089-00	METAL GLAZE	47K 5% 1/10W
R366	1-216-244-00	METAL GLAZE	82K 5% 1/8W	R1038	1-216-081-00	METAL GLAZE	22K 5% 1/10W
R367	1-216-244-00	METAL GLAZE	82K 5% 1/8W	R1040	1-216-025-00	METAL GLAZE	100 5% 1/10W
R368	1-216-055-00	METAL GLAZE	1.8K 5% 1/10W	R1042	1-216-047-00	METAL GLAZE	820 5% 1/10W
R369	1-216-248-00	METAL GLAZE	120K 5% 1/8W	R1043	1-216-057-00	METAL GLAZE	2.2K 5% 1/10W
R370	1-216-115-00	METAL GLAZE	560K 5% 1/10W	R1044	1-216-061-00	METAL GLAZE	3.3K 5% 1/10W
R371	1-216-067-00	METAL GLAZE	5.6K 5% 1/10W	R1045	1-216-125-00	METAL GLAZE	1.5M 5% 1/10W
R372	1-216-115-00	METAL GLAZE	560K 5% 1/10W	R1046	1-216-689-11	METAL CHIP	39K 0.50% 1/10W
R374	1-216-115-00	METAL GLAZE	560K 5% 1/10W	R1047	1-216-065-00	METAL GLAZE	4.7K 5% 1/10W
R375	1-216-683-11	METAL CHIP	22K 0.50% 1/10W	R1048	1-216-049-00	METAL GLAZE	1K 5% 1/10W
R376	1-216-663-11	METAL CHIP	3.3K 0.50% 1/10W	R1049	1-216-085-00	METAL GLAZE	33K 5% 1/10W
R378	1-216-025-00	METAL GLAZE	100 5% 1/10W	R1050	1-216-059-00	METAL GLAZE	2.7K 5% 1/10W
R379	1-216-641-11	METAL CHIP	390 0.50% 1/10W	R1051	1-216-105-00	METAL GLAZE	220K 5% 1/10W
R380	1-216-668-11	METAL CHIP	5.1K 0.50% 1/10W	R1053	1-216-091-00	METAL GLAZE	56K 5% 1/10W
R381	1-216-089-00	METAL GLAZE	47K 5% 1/10W	R1054	1-216-093-00	METAL GLAZE	68K 5% 1/10W
R382	1-216-025-00	METAL GLAZE	100 5% 1/10W	R1055	1-216-097-00	METAL GLAZE	100K 5% 1/10W
R383	1-216-641-11	METAL CHIP	390 0.50% 1/10W	R1056	1-216-037-00	METAL GLAZE	330 5% 1/10W
R384	1-216-668-11	METAL CHIP	5.1K 0.50% 1/10W	R1057	1-216-065-00	METAL GLAZE	4.7K 5% 1/10W
R385	1-216-117-00	METAL GLAZE	680K 5% 1/10W	R1058	1-216-109-00	METAL GLAZE	330K 5% 1/10W
R386	1-216-025-00	METAL GLAZE	100 5% 1/10W	R1059	1-216-109-00	METAL GLAZE	330K 5% 1/10W
R387	1-216-641-11	METAL CHIP	390 0.50% 1/10W	R1060	1-216-109-00	METAL GLAZE	330K 5% 1/10W
R388	1-216-668-11	METAL CHIP	5.1K 0.50% 1/10W	R1061	1-216-109-00	METAL GLAZE	330K 5% 1/10W
R390	1-216-105-00	METAL GLAZE	220K 5% 1/10W	R1062	1-216-103-00	METAL GLAZE	180K 5% 1/10W
R391	1-216-081-00	METAL GLAZE	22K 5% 1/10W	R1063	1-216-103-00	METAL GLAZE	180K 5% 1/10W
R392	1-216-113-00	METAL GLAZE	470K 5% 1/10W	R1064	1-216-103-00	METAL GLAZE	180K 5% 1/10W
R393	1-216-085-00	METAL GLAZE	33K 5% 1/10W	R1065	1-216-103-00	METAL GLAZE	180K 5% 1/10W
R394	1-216-113-00	METAL GLAZE	470K 5% 1/10W	R1066	1-216-073-00	METAL GLAZE	10K 5% 1/10W
R397	1-249-437-11	CARBON	47K 5% 1/4W F	R1067	1-216-073-00	METAL GLAZE	10K 5% 1/10W
R398	1-249-434-11	CARBON	27K 5% 1/4W F	R1068	1-216-049-00	METAL GLAZE	1K 5% 1/10W
R399	1-216-073-00	METAL GLAZE	10K 5% 1/10W	R1069	1-216-133-00	METAL GLAZE	3.3M 5% 1/10W
R1001	1-216-073-00	METAL GLAZE	10K 5% 1/10W	R1070	1-216-085-00	METAL GLAZE	33K 5% 1/10W
R1002	1-216-047-00	METAL GLAZE	820 5% 1/10W	R1071	1-216-113-00	METAL GLAZE	470K 5% 1/10W
R1003	1-216-055-00	METAL GLAZE	1.8K 5% 1/10W	R1072	1-216-099-00	METAL GLAZE	120K 5% 1/10W
R1004	1-216-061-00	METAL GLAZE	3.3K 5% 1/10W	R1073	1-216-131-11	METAL GLAZE	2.7M 5% 1/10W
R1005	1-216-047-00	METAL GLAZE	820 5% 1/10W	R1075	1-216-065-00	METAL GLAZE	4.7K 5% 1/10W
R1006	1-216-055-00	METAL GLAZE	1.8K 5% 1/10W	R1076	1-216-101-00	METAL GLAZE	150K 5% 1/10W
R1007	1-216-061-00	METAL GLAZE	3.3K 5% 1/10W	R1077	1-216-103-00	METAL GLAZE	180K 5% 1/10W
R1008	1-216-047-00	METAL GLAZE	820 5% 1/10W	R1079	1-216-131-11	METAL GLAZE	2.7M 5% 1/10W
R1009	1-216-055-00	METAL GLAZE	1.8K 5% 1/10W	R1080	1-216-097-00	METAL GLAZE	100K 5% 1/10W
R1010	1-216-061-00	METAL GLAZE	3.3K 5% 1/10W	R1081	1-216-097-00	METAL GLAZE	100K 5% 1/10W
R1011	1-216-033-00	METAL GLAZE	220 5% 1/10W	R1082	1-216-105-00	METAL GLAZE	220K 5% 1/10W
R1012	1-216-051-00	METAL GLAZE	1.2K 5% 1/10W	R1083	1-216-065-00	METAL GLAZE	4.7K 5% 1/10W
R1013	1-216-051-00	METAL GLAZE	1.2K 5% 1/10W	R1084	1-216-063-00	METAL GLAZE	3.9K 5% 1/10W
R1014	1-216-246-00	METAL GLAZE	100K 5% 1/8W	R1086	1-216-073-00	METAL GLAZE	10K 5% 1/10W
R1015	1-216-033-00	METAL GLAZE	220 5% 1/10W				
R1016	1-216-089-00	METAL GLAZE	47K 5% 1/10W				



The components identified by shading and mark Δ are critical for safety. Replace only with part number specified.

REF. NO.	PART NO.	DESCRIPTION	REMARK	REF. NO.	PART NO.	DESCRIPTION	REMARK
<MODULE>				<NEON LAMP>			
SEP101	1-808-654-11	MODULE		NL801	1-519-108-XX	LAMP, NEON	
<CRYSTAL>				<TRANSISTOR>			
X101	1-527-722-00	OSCILLATOR, CRYSTAL		Q801	8-729-195-82	TRANSISTOR 2SC2958	
X102	1-577-259-11	VIBRATOR, CRYSTAL		Q802	8-729-201-62	TRANSISTOR 2SC2555	
*****				4-363-404-00		HOLDER, IC; Q802	
*A-1195-048-A		P BOARD, COMPLETE		4-382-854-01		SCREW (M3X8), P, SW (+); Q802	
		*****		4-879-937-00		SHEET, MICA; Q802	
<CAPACITOR>				Q803	8-729-906-24	TRANSISTOR 2SD835	
C801	1-126-104-11	ELECT	470MF 20%	35V			
C802	1-162-318-11	CERAMIC	0.001MF 10%	500V			
C803	1-102-228-00	CERAMIC	470PF 10%	500V			
C804	1-123-935-00	ELECT	33MF 20%	160V			
C805	1-101-004-00	CERAMIC	0.01MF	50V			
C806	1-124-480-11	ELECT	470MF 20%	25V			
C807	1-102-228-00	CERAMIC	470PF 10%	500V			
C808	1-106-367-00	MYLAR	0.01MF 10%	100V			
C809	1-106-375-12	MYLAR	0.022MF 10%	100V			
C810	1-162-318-11	CERAMIC	0.001MF 10%	500V			
C811	Δ 1-137-544-11	FILM	0.01MF 3%	600V			
C812	Δ 1-137-545-11	FILM	0.013MF 3%	600V			
C813	1-106-385-00	MYLAR	0.056MF 5%	200V			
C814	1-106-383-00	MYLAR	0.047MF 10%	100V			
C815	1-126-233-11	ELECT	22MF 20%	50V			
C816	1-124-798-11	ELECT	1MF 20%	160V			
C817	1-130-800-00	FILM	2.2MF 10%	250V			
C818	1-102-228-00	CERAMIC	470PF 10%	500V			
C819	1-162-116-00	CERAMIC	680PF 10%	2KV			
C820	1-162-116-00	CERAMIC	680PF 10%	2KV			
<CONNECTOR>				<RESISTOR>			
CN801	*1-564-595-11	PLUG, CONNECTOR 14P		R801	1-249-383-11	CARBON	1.5 5% 1/4W F
CN802	*1-508-766-00	PIN, CONNECTOR (5MM PITCH) 4P		R802	1-249-377-11	CARBON	0.47 5% 1/4W F
CN803	*1-564-508-11	PLUG, CONNECTOR 5P		R803	1-216-049-00	METAL GLAZE	1K 5% 1/10W
CN805	*1-560-123-00	PLUG, CONNECTOR (2.5MM) 3P		R804	1-249-419-11	CARBON	1.5K 5% 1/4W F
				R805	1-215-892-11	METAL OXIDE	1K 5% 2W F
<DIODE>				R807	1-216-425-11	METAL OXIDE	56 5% 1W F
D801	8-719-300-33	DIODE RU-3AM		R808	1-202-846-00	SOLID	470K 20% 1/2W
D802	8-719-300-33	DIODE RU-3AM		R809	1-216-089-00	METAL GLAZE	47K 5% 1/10W
D803	8-719-300-33	DIODE RU-3AM		R810	1-249-421-11	CARBON	2.2K 5% 1/4W F
D804	8-719-979-85	DIODE EGP-20G		R811	1-216-049-00	METAL GLAZE	1K 5% 1/10W
D805	8-719-300-33	DIODE RU-3AM		R812	1-249-439-11	CARBON	68K 5% 1/4W F
D806	8-719-300-33	DIODE RU-3AM		R813	1-249-414-11	CARBON	560 5% 1/4W F
D807	8-719-105-XX	DIODE RD6.2M-B1		R814	1-249-377-11	CARBON	0.47 5% 1/4W F
D808	8-719-008-28	THYRISTOR CRO2AM-4TB					
D809	8-719-911-55	DIODE U05G		<VARIABLE RESISTOR>			
D810	8-719-911-55	DIODE U05G		RV801	1-223-102-00	RES, ADJ, WIREWOUND 120	
D811	8-719-911-55	DIODE U05G		<TRANSFORMER>			
D813	8-719-300-33	DIODE RU-3AM		T801	1-437-082-31	HDT	
<COIL>				T802	Δ 1-439-526-11	TRANSFORMER ASSY, FLYBACK	
L802	1-459-442-00	COIL (WITH CORE)		*****			
L803	1-422-613-11	COIL, AIR CORE		*1-641-723-11		FA BOARD	
L804	1-459-109-00	COIL, DUST CORE				*****	
L805	Δ 1-460-225-11	COIL, HORIZONTAL LINEARITY		1-533-223-11		CLIP, FUSE	
L806	1-407-500-00	INDUCTOR 4.7MMH		*4-341-751-01		EYELET EY6, EY7	
L807	1-407-500-00	INDUCTOR 4.7MMH		*4-341-752-01		EYELET EY1, EY3, EY8, EY9	
<SWITCH>				<CONNECTOR>			
				CN601	*1-580-689-11	PIN, CONNECTOR (PC BOARD) 4P	
				CN602	*1-508-765-00	PIN, CONNECTOR (5MM PITCH) 3P	
				CN603	1-564-507-11	PLUG, CONNECTOR 4P	
				<FUSE>			
				F601	Δ 1-576-230-11	FUSE (H.B.C.) (3.15A/250V)	
				<RESISTOR>			
				R602	1-202-721-00	SOLID	1.5M 20% 1/2W

The components identified by shading and mark **△** are critical for safety.
Replace only with part number specified.

QA

REF. NO.	PART NO.	DESCRIPTION	REMARK	REF. NO.	PART NO.	DESCRIPTION	REMARK
A-1275-099-A	QA BOARD, COMPLETE *****			C453	1-124-234-00	ELECT 22MF	20% 16V
1-537-408-11	TERMINAL BOARD, IN/OUT (LINE B)			C454	1-128-499-11	ELECT 220MF	20% 16V
△ 1-537-410-11	TERMINAL BOARD, IN/OUT (LINE A)& AC INLET			C460	1-126-301-11	ELECT 1MF	20% 50V
*4-341-752-01	EYELET EY10, EY11			C461	1-126-301-11	ELECT 1MF	20% 50V
<CAPACITOR>				C462	1-126-301-11	ELECT 1MF	20% 50V
C401	1-124-234-00	ELECT 22MF	20% 16V	C464	1-163-031-11	CERAMIC CHIP 0.01MF	50V
C402	1-124-234-00	ELECT 22MF	20% 16V	C465	1-163-031-11	CERAMIC CHIP 0.01MF	50V
C403	1-124-234-00	ELECT 22MF	20% 16V	C466	1-163-031-11	CERAMIC CHIP 0.01MF	50V
C404	1-124-234-00	ELECT 22MF	20% 16V	C467	1-163-031-11	CERAMIC CHIP 0.01MF	50V
C405	1-124-234-00	ELECT 22MF	20% 16V	<CONNECTOR>			
C406	1-124-234-00	ELECT 22MF	20% 16V	CN401	1-506-494-11	PIN, CONNECTOR 15P	
C407	1-124-234-00	ELECT 22MF	20% 16V	CN402	*1-564-518-11	PLUG, CONNECTOR 3P	
C408	1-124-463-00	ELECT 0.1MF	20% 50V	CN403	*1-580-690-11	PIN, CONNECTOR (PC BOARD) 4P	
C409	1-124-234-00	ELECT 22MF	20% 16V	CN404	*1-564-519-11	PLUG, CONNECTOR 4P	
C410	1-124-234-00	ELECT 22MF	20% 16V	<DIODE>			
C411	1-124-234-00	ELECT 22MF	20% 16V	D401	8-719-404-46	DIODE MA110	
C412	1-124-234-00	ELECT 22MF	20% 16V	D402	8-719-404-46	DIODE MA110	
C413	1-124-234-00	ELECT 22MF	20% 16V	D403	8-719-110-09	DIODE RD8.2ES-B3	
C414	1-126-157-11	ELECT 10MF	20% 16V	D404	8-719-404-46	DIODE MA110	
C415	1-126-157-11	ELECT 10MF	20% 16V	D405	8-719-404-46	DIODE MA110	
C416	1-126-157-11	ELECT 10MF	20% 16V	D406	8-719-404-46	DIODE MA110	
C417	1-126-157-11	ELECT 10MF	20% 16V	D407	8-719-404-46	DIODE MA110	
C418	1-126-157-11	ELECT 10MF	20% 16V	D408	8-719-404-46	DIODE MA110	
C419	1-126-157-11	ELECT 10MF	20% 16V	D409	8-719-404-46	DIODE MA110	
C420	1-126-157-11	ELECT 10MF	20% 16V	D410	8-719-404-46	DIODE MA110	
C421	1-102-125-00	CERAMIC 0.0047MF	10% 50V	D411	8-719-404-46	DIODE MA110	
C422	1-124-464-11	ELECT 0.22MF	20% 50V	D412	8-719-404-46	DIODE MA110	
C423	1-126-157-11	ELECT 10MF	20% 16V	D413	8-719-404-46	DIODE MA110	
C424	1-126-157-11	ELECT 10MF	20% 16V	D414	8-719-404-46	DIODE MA110	
C425	1-108-634-11	MYLAR 0.047MF	10% 100V	D415	8-719-404-46	DIODE MA110	
C426	1-128-499-11	ELECT 220MF	20% 16V	D416	8-719-404-46	DIODE MA110	
C427	1-128-499-11	ELECT 220MF	20% 16V	D417	8-719-404-46	DIODE MA110	
C428	1-124-589-11	ELECT 47MF	20% 16V	D418	8-719-404-46	DIODE MA110	
C429	1-124-234-00	ELECT 22MF	20% 16V	D419	8-719-404-46	DIODE MA110	
C430	1-163-033-00	CERAMIC CHIP 0.022MF	50V	D420	8-719-404-46	DIODE MA110	
C431	1-124-234-00	ELECT 22MF	20% 16V	D421	8-719-404-46	DIODE MA110	
C432	1-163-033-00	CERAMIC CHIP 0.022MF	50V	D422	8-719-404-46	DIODE MA110	
C433	1-124-234-00	ELECT 22MF	20% 16V	D423	8-719-404-46	DIODE MA110	
C434	1-163-033-00	CERAMIC CHIP 0.022MF	50V	D424	8-719-404-46	DIODE MA110	
C435	1-124-234-00	ELECT 22MF	20% 16V	D425	8-719-404-46	DIODE MA110	
C436	1-163-033-00	CERAMIC CHIP 0.022MF	50V	D426	8-719-404-46	DIODE MA110	
C437	1-163-033-00	CERAMIC CHIP 0.022MF	50V	D427	8-719-404-46	DIODE MA110	
C438	1-124-234-00	ELECT 22MF	20% 16V	D428	8-719-404-46	DIODE MA110	
C439	1-163-033-00	CERAMIC CHIP 0.022MF	50V	D429	8-719-404-46	DIODE MA110	
C440	1-163-033-00	CERAMIC CHIP 0.022MF	50V	D430	8-719-404-46	DIODE MA110	
C441	1-124-234-00	ELECT 22MF	20% 16V	D431	8-719-404-46	DIODE MA110	
C442	1-163-033-00	CERAMIC CHIP 0.022MF	50V	<IC>			
C443	1-163-033-00	CERAMIC CHIP 0.022MF	50V	IC401	8-759-501-21	IC MM1149XF	
C444	1-163-033-00	CERAMIC CHIP 0.022MF	50V	IC402	8-759-501-21	IC MM1149XF	
C445	1-163-031-11	CERAMIC CHIP 0.01MF	50V	IC403	8-759-420-04	IC AN5265	
C446	1-163-031-11	CERAMIC CHIP 0.01MF	50V	<COIL>			
C447	1-126-301-11	ELECT 1MF	20% 50V	L401	1-410-682-31	INDUCTOR 470UH	
C448	1-124-234-00	ELECT 22MF	20% 16V	L402	1-410-682-31	INDUCTOR 470UH	
C449	1-163-031-11	CERAMIC CHIP 0.01MF	50V				
C450	1-124-234-00	ELECT 22MF	20% 16V				
C451	1-163-033-00	CERAMIC CHIP 0.022MF	50V				
C452	1-128-499-11	ELECT 220MF	20% 16V				

QA

REF. NO.	PART NO.	DESCRIPTION	REMARK	REF. NO.	PART NO.	DESCRIPTION	REMARK
<TRANSISTOR>							
Q401	8-729-920-74	TRANSISTOR 2SC2412K-QR		R438	1-216-091-00	METAL GLAZE 56K 5%	1/10W
Q402	8-729-920-74	TRANSISTOR 2SC2412K-QR		R439	1-216-063-00	METAL GLAZE 3.9K 5%	1/10W
Q403	8-729-216-22	TRANSISTOR 2SA1162-G		R440	1-216-027-00	METAL GLAZE 120 5%	1/10W
Q404	8-729-920-74	TRANSISTOR 2SC2412K-QR		R441	1-216-089-00	METAL GLAZE 47K 5%	1/10W
Q405	8-729-920-74	TRANSISTOR 2SC2412K-QR		R442	1-216-049-00	METAL GLAZE 1K 5%	1/10W
Q406	8-729-920-74	TRANSISTOR 2SC2412K-QR		R443	1-216-087-11	METAL GLAZE 39K 5%	1/10W
Q407	8-729-920-74	TRANSISTOR 2SC2412K-QR		R444	1-214-702-00	METAL 75 1%	1/4W
Q408	8-729-920-74	TRANSISTOR 2SC2412K-QR		R445	1-216-049-00	METAL GLAZE 1K 5%	1/10W
Q409	8-729-920-74	TRANSISTOR 2SC2412K-QR		R446	1-216-093-00	METAL GLAZE 68K 5%	1/10W
Q410	8-729-920-74	TRANSISTOR 2SC2412K-QR		R447	1-216-091-00	METAL GLAZE 56K 5%	1/10W
Q411	8-729-216-22	TRANSISTOR 2SA1162-G		R448	1-216-063-00	METAL GLAZE 3.9K 5%	1/10W
Q412	8-729-216-22	TRANSISTOR 2SA1162-G		R449	1-216-027-00	METAL GLAZE 120 5%	1/10W
Q413	8-729-216-22	TRANSISTOR 2SA1162-G		R450	1-214-702-00	METAL 75 1%	1/4W
Q414	8-729-216-22	TRANSISTOR 2SA1162-G		R451	1-216-049-00	METAL GLAZE 1K 5%	1/10W
Q416	8-729-145-18	TRANSISTOR 2SC3736		R452	1-216-091-00	METAL GLAZE 56K 5%	1/10W
Q417	8-729-901-06	TRANSISTOR DTA144EK		R453	1-216-093-00	METAL GLAZE 68K 5%	1/10W
Q418	8-729-901-06	TRANSISTOR DTA144EK		R454	1-216-063-00	METAL GLAZE 3.9K 5%	1/10W
Q419	8-729-901-06	TRANSISTOR DTA144EK		R455	1-216-037-00	METAL GLAZE 330 5%	1/10W
Q420	8-729-901-01	TRANSISTOR DTC144EK		R456	1-216-085-00	METAL GLAZE 33K 5%	1/10W
Q421	8-729-901-06	TRANSISTOR DTA144EK		R457	1-216-085-00	METAL GLAZE 33K 5%	1/10W
Q422	8-729-901-01	TRANSISTOR DTC144EK		R458	1-247-707-11	CARBON 390 5%	1/4W
Q423	8-729-901-06	TRANSISTOR DTA144EK		R459	1-216-087-11	METAL GLAZE 39K 5%	1/10W
Q424	8-729-901-06	TRANSISTOR DTA144EK		R460	1-216-089-00	METAL GLAZE 47K 5%	1/10W
<RESISTOR>							
R401	1-214-702-00	METAL 75 1%	1/4W	R461	1-216-097-00	METAL GLAZE 100K 5%	1/10W
R402	1-216-049-00	METAL GLAZE 1K 5%	1/10W	R462	1-216-115-00	METAL GLAZE 560K 5%	1/10W
R403	1-216-093-00	METAL GLAZE 68K 5%	1/10W	R463	1-216-105-00	METAL GLAZE 220K 5%	1/10W
R404	1-216-091-00	METAL GLAZE 56K 5%	1/10W	R464	1-216-077-00	METAL GLAZE 15K 5%	1/10W
R405	1-216-063-00	METAL GLAZE 3.9K 5%	1/10W	R465	1-216-025-00	METAL GLAZE 100 5%	1/10W
R406	1-216-037-00	METAL GLAZE 330 5%	1/10W	R466	1-216-097-00	METAL GLAZE 100K 5%	1/10W
R407	1-216-087-11	METAL GLAZE 39K 5%	1/10W	R467	1-216-115-00	METAL GLAZE 560K 5%	1/10W
R408	1-216-085-00	METAL GLAZE 33K 5%	1/10W	R468	1-216-105-00	METAL GLAZE 220K 5%	1/10W
R409	1-214-702-00	METAL 75 1%	1/4W	R469	1-216-077-00	METAL GLAZE 15K 5%	1/10W
R410	1-216-049-00	METAL GLAZE 1K 5%	1/10W	R470	1-216-025-00	METAL GLAZE 100 5%	1/10W
R411	1-216-093-00	METAL GLAZE 68K 5%	1/10W	R471	1-216-097-00	METAL GLAZE 100K 5%	1/10W
R412	1-216-091-00	METAL GLAZE 56K 5%	1/10W	R472	1-216-115-00	METAL GLAZE 560K 5%	1/10W
R413	1-216-063-00	METAL GLAZE 3.9K 5%	1/10W	R473	1-216-105-00	METAL GLAZE 220K 5%	1/10W
R414	1-216-037-00	METAL GLAZE 330 5%	1/10W	R474	1-216-077-00	METAL GLAZE 15K 5%	1/10W
R415	1-216-061-00	METAL GLAZE 3.3K 5%	1/10W	R475	1-216-025-00	METAL GLAZE 100 5%	1/10W
R416	1-216-023-00	METAL GLAZE 82 5%	1/10W	R477	1-216-081-00	METAL GLAZE 22K 5%	1/10W
R417	1-216-049-00	METAL GLAZE 1K 5%	1/10W	R479	1-216-085-00	METAL GLAZE 33K 5%	1/10W
R418	1-216-093-00	METAL GLAZE 68K 5%	1/10W	R480	1-247-711-11	CARBON 680 5%	1/4W
R419	1-216-091-00	METAL GLAZE 56K 5%	1/10W	R481	1-247-720-11	CARBON 3.9K 5%	1/4W
R420	1-216-063-00	METAL GLAZE 3.9K 5%	1/10W	R482	1-249-455-11	CARBON 4.7 5%	1/4W
R421	1-216-027-00	METAL GLAZE 120 5%	1/10W	R483	1-249-389-11	CARBON 4.7 5%	1/4W F
R422	1-214-702-00	METAL 75 1%	1/4W	R484	1-216-041-00	METAL GLAZE 470 5%	1/10W
R423	1-214-702-00	METAL 75 1%	1/4W	R485	1-247-688-11	CARBON 10 5%	1/4W F
R424	1-216-049-00	METAL GLAZE 1K 5%	1/10W	R486	1-216-037-00	METAL GLAZE 330 5%	1/10W
R425	1-216-093-00	METAL GLAZE 68K 5%	1/10W	R487	1-249-468-11	CARBON 82K 5%	1/4W
R426	1-216-091-00	METAL GLAZE 56K 5%	1/10W	R488	1-249-468-11	CARBON 82K 5%	1/4W
R427	1-216-063-00	METAL GLAZE 3.9K 5%	1/10W	R489	1-249-468-11	CARBON 82K 5%	1/4W
R428	1-216-037-00	METAL GLAZE 330 5%	1/10W	R490	1-216-057-00	METAL GLAZE 2.2K 5%	1/10W
R429	1-214-702-00	METAL 75 1%	1/4W	R491	1-216-089-00	METAL GLAZE 47K 5%	1/10W
R430	1-216-049-00	METAL GLAZE 1K 5%	1/10W	R492	1-216-089-00	METAL GLAZE 47K 5%	1/10W
R431	1-216-093-00	METAL GLAZE 68K 5%	1/10W	R493	1-216-089-00	METAL GLAZE 47K 5%	1/10W
R432	1-216-091-00	METAL GLAZE 56K 5%	1/10W	R494	1-216-089-00	METAL GLAZE 47K 5%	1/10W
R433	1-216-063-00	METAL GLAZE 3.9K 5%	1/10W	R495	1-216-295-00	METAL GLAZE 0 5%	1/10W
R434	1-216-027-00	METAL GLAZE 120 5%	1/10W	R496	1-216-057-00	METAL GLAZE 2.2K 5%	1/10W
R435	1-214-702-00	METAL 75 1%	1/4W	R497	1-216-089-00	METAL GLAZE 47K 5%	1/10W
R436	1-216-049-00	METAL GLAZE 1K 5%	1/10W	R498	1-216-089-00	METAL GLAZE 47K 5%	1/10W
R437	1-216-093-00	METAL GLAZE 68K 5%	1/10W	R499	1-216-089-00	METAL GLAZE 47K 5%	1/10W
				R1401	1-216-097-00	METAL GLAZE 100K 5%	1/10W
				R1403	1-216-295-00	METAL GLAZE 0 5%	1/10W
				R1404	1-216-097-00	METAL GLAZE 100K 5%	1/10W



REF. NO.	PART NO.	DESCRIPTION	REMARK	REF. NO.	PART NO.	DESCRIPTION	REMARK
<VARIABLE RESISTOR>				C512	1-106-375-12	MYLAR	0.022MF 10% 100V
RV401	1-230-481-11	RES, VAR, CARBON 20K		C513	1-106-375-12	MYLAR	0.022MF 10% 100V
*****				C514	1-106-371-00	MYLAR	0.015MF 10% 100V
*1-641-720-11	CA BOARD			C515	1-124-925-11	ELECT	2.2MF 20% 50V
	*****			C516	1-124-925-11	ELECT	2.2MF 20% 50V
1-526-958-41	SOCKET, PICTURE TUBE			C517	1-130-480-00	FILM	0.0056MF 5% 50V
*****				C518	1-163-245-11	CERAMIC CHIP	56PF 5% 50V
<CAPACITOR>				C519	1-124-927-11	ELECT	4.7MF 20% 50V
C701	1-162-114-00	CERAMIC	0.0047MF 10% 2KV	C520	1-163-129-00	CERAMIC CHIP	330PF 5% 50V
C702	1-102-050-00	CERAMIC	0.01MF 99% 500V	C521	1-124-907-11	ELECT	10MF 20% 50V
C710	1-161-830-00	CERAMIC	0.0047MF 99% 500V	C523	1-106-363-00	MYLAR	0.0068MF 10% 100V
*****				C524	1-102-116-00	CERAMIC	680PF 10% 50V
<CONNECTOR>				C525	1-102-820-00	CERAMIC	330PF 5% 50V
CN701	*1-564-509-11	PLUG, CONNECTOR 6P		C526	1-102-973-00	CERAMIC	100PF 5% 50V
CN702	*1-508-784-00	PIN, CONNECTOR (5MM PITCH) 1P		C527	1-124-122-11	ELECT	100MF 20% 50V
CN703	*1-564-508-11	PLUG, CONNECTOR 5P		C528	1-102-125-00	CERAMIC	0.0047MF 10% 50V
*****				C529	1-124-910-11	ELECT	47MF 20% 50V
<COIL>				C530	1-163-097-00	CERAMIC CHIP	15PF 5% 50V
L701	1-410-668-11	INDUCTOR	27UH	C531	1-131-370-00	TANTALUM	6.8MF 10% 16V
*****				C532	1-124-557-11	ELECT	1000MF 20% 25V
<RESISTOR>				C533	1-124-927-11	ELECT	4.7MF 20% 50V
R701	1-202-822-00	SOLID	2.2K 20% 1/2W	C534	1-124-768-11	ELECT	4.7MF 20% 50V
R702	1-202-822-00	SOLID	2.2K 20% 1/2W	C535	1-136-161-00	FILM	0.047MF 5% 50V
R703	1-202-822-00	SOLID	2.2K 20% 1/2W	C536	1-124-927-11	ELECT	4.7MF 20% 50V
R704	1-202-838-00	SOLID	100K 20% 1/2W	C537	1-124-484-11	ELECT	220MF 20% 35V
R705	1-202-719-00	SOLID	1M 20% 1/2W	C538	1-124-910-11	ELECT	47MF 20% 50V
R706	1-202-842-11	SOLID	220K 20% 1/2W	C539	1-136-113-00	FILM	2MF 5% 200V
*****				C540	1-163-017-00	CERAMIC CHIP	0.0047MF 10% 50V
<VARIABLE RESISTOR>				C541	1-163-035-00	CERAMIC CHIP	0.047MF 50V
RV701	1-230-164-00	RES, ADJ, METAL GLAZE 55M		C542	1-126-103-11	ELECT	470MF 20% 16V
	*4-376-132-11	COVER (REAR LID), CV VOL; RV701		C545	1-126-101-11	ELECT	100MF 20% 16V
	*4-376-133-11	COVER (MAIN), CV VOL; RV701		C546	1-124-907-11	ELECT	10MF 20% 50V
*****				C547	1-124-907-11	ELECT	10MF 20% 50V
A-1346-018-A	D BOARD, COMPLETE			C548	1-124-907-11	ELECT	10MF 20% 50V
	*****			C549	1-124-907-11	ELECT	10MF 20% 50V
1-533-189-11	HOLDER, FUSE			C550	1-124-907-11	ELECT	10MF 20% 50V
3-710-578-01	COVER, VOLUME, 6 MOLD			C551	1-124-927-11	ELECT	4.7MF 20% 50V
*3-738-015-01	COVER, (DIA. 6) CARBON VR			C552	1-101-004-00	CERAMIC	0.01MF 50V
4-382-854-01	SCREW (M3X8), P, SW (+)			C553	1-126-103-11	ELECT	470MF 20% 16V
4-382-854-11	SCREW (M3X10), P, SW (+)			C563	1-106-383-00	MYLAR	0.047MF 10% 100V
*****				C564	1-163-009-11	CERAMIC CHIP	0.001MF 10% 50V
<CAPACITOR>				C567	1-124-907-11	ELECT	10MF 20% 50V
C501	1-124-477-11	ELECT	47MF 20% 16V	C568	1-130-736-11	FILM	0.01MF 5% 50V
C502	1-124-907-11	ELECT	10MF 20% 50V	C569	1-130-471-00	FILM	0.001MF 5% 50V
C503	1-126-103-11	ELECT	470MF 20% 16V	C570	1-163-117-00	CERAMIC CHIP	100PF 5% 50V
C504	1-124-902-00	ELECT	0.47MF 20% 50V	C571	1-124-913-11	ELECT	470MF 20% 50V
C505	1-106-381-12	MYLAR	0.039MF 10% 100V	C572	1-101-004-00	CERAMIC	0.01MF 50V
C506	1-124-903-11	ELECT	1MF 20% 50V	C574	1-106-351-00	MYLAR	0.0022MF 10% 100V
C507	1-106-367-00	MYLAR	0.01MF 10% 100V	C575	1-106-351-00	MYLAR	0.0022MF 10% 100V
C508	1-124-903-11	ELECT	1MF 20% 50V	C831	1-124-907-11	ELECT	10MF 20% 50V
C509	1-136-173-00	FILM	0.47MF 5% 50V	C832	1-124-907-11	ELECT	10MF 20% 50V
C510	1-136-161-00	FILM	0.047MF 5% 50V	C833	1-163-009-11	CERAMIC CHIP	0.001MF 10% 50V
C511	1-124-903-11	ELECT	1MF 20% 50V	C834	1-163-121-00	CERAMIC CHIP	150PF 5% 50V
				C835	1-163-209-00	CERAMIC CHIP	0.0015MF 5% 50V
				C836	1-124-907-11	ELECT	10MF 20% 50V
				C837	1-163-209-00	CERAMIC CHIP	0.0015MF 5% 50V
				C838	1-136-163-00	FILM	0.068MF 5% 50V
				C839	1-106-351-00	MYLAR	0.0022MF 10% 100V
				C840	1-163-209-00	CERAMIC CHIP	0.0015MF 5% 50V
				C841	1-163-209-00	CERAMIC CHIP	0.0015MF 5% 50V
				C843	1-124-902-00	ELECT	0.47MF 20% 50V
				C844	1-124-902-00	ELECT	0.47MF 20% 50V
				C845	1-124-477-11	ELECT	47MF 20% 25V
				C846	1-124-907-11	ELECT	10MF 20% 50V

D

The components identified by shading and mark Δ are critical for safety. Replace only with part number specified.

REF. NO.	PART NO.	DESCRIPTION	REMARK	REF. NO.	PART NO.	DESCRIPTION	REMARK
C847	1-126-233-11	ELECT 22MF	20%	50V	D1611	8-729-101-31	TRANSISTOR N13T1
C848	1-131-351-00	TANTALUM 4.7MF	10%	35V	D1612	8-719-404-46	DIODE MA110
C849	1-164-182-11	CERAMIC CHIP 0.0033MF	10%	50V	D1613	8-719-404-46	DIODE MA110
C1601	1-124-907-11	ELECT 10MF	20%	50V	D1614	8-719-404-46	DIODE MA110
C1602	1-164-161-11	CERAMIC CHIP 0.0022MF	10%	50V	D1615	8-719-404-46	DIODE MA110
C1603	1-124-903-11	ELECT 1MF	20%	50V	D1616	8-719-404-46	DIODE MA110
C1604	1-128-500-51	ELECT 1000MF	20%	50V	D1617	8-719-977-49	DIODE DTZ15B
C1605	1-124-922-11	ELECT 1000MF	20%	50V	D1618	8-719-977-49	DIODE DTZ15B
C1606	1-102-074-00	CERAMIC 0.001MF	10%	50V	D1621	8-719-510-12	DIODE D10SC4M
C1607	1-124-907-11	ELECT 10MF	20%	50V	D1625	8-719-404-46	DIODE MA110
C1608	1-126-233-11	ELECT 22MF	20%	50V	D1626	8-719-404-46	DIODE MA110
C1609	1-163-009-11	CERAMIC CHIP 0.001MF	10%	50V	D1627	8-719-404-46	DIODE MA110
C1610	1-124-927-11	ELECT 4.7MF	20%	50V	D1628	8-719-404-46	DIODE MA110
C1611	1-124-482-11	ELECT 33MF	20%	35V	D1635	8-719-404-46	DIODE MA110
C1612	1-136-257-00	FILM 0.0039MF	5%	50V	D1699	8-719-404-46	DIODE MA110
C1613	1-163-009-11	CERAMIC CHIP 0.001MF	10%	50V			
C1614	1-164-232-11	CERAMIC CHIP 0.01MF	10%	50V			
C1615	1-124-465-00	ELECT 0.47MF	20%	50V			
C1620	1-163-133-00	CERAMIC CHIP 470PF	5%	50V			
C1621	1-163-117-00	CERAMIC CHIP 100PF	5%	50V			
<CONNECTOR>							
CN501	*1-564-506-11	PLUG, CONNECTOR 3P					
CN502	1-506-477-11	PIN, CONNECTOR 12P					
CN504	*1-564-507-11	PLUG, CONNECTOR 4P					
CN505	*1-564-509-11	PLUG, CONNECTOR 6P					
CN507	*1-564-511-11	PLUG, CONNECTOR 8P					
CN508	*1-564-104-00	PIN, CONNECTOR (B3P-VH) 3P					
CN509	*1-564-506-11	PLUG, CONNECTOR 3P					
<DIODE>							
D501	8-719-404-46	DIODE MA110					
D502	8-719-404-46	DIODE MA110					
D503	8-719-404-46	DIODE MA110					
D504	8-719-404-46	DIODE MA110					
D505	8-719-404-46	DIODE MA110					
D506	8-719-911-55	DIODE U05G					
D507	8-719-404-46	DIODE MA110					
D508	8-719-404-46	DIODE MA110					
D509	8-719-404-46	DIODE MA110					
D510	8-719-404-46	DIODE MA110					
D511	8-719-404-46	DIODE MA110					
D512	8-719-404-46	DIODE MA110					
D514	8-719-404-46	DIODE MA110					
D831	8-719-404-46	DIODE MA110					
D832	8-719-404-46	DIODE MA110					
D833	8-719-404-46	DIODE MA110					
D834	8-719-404-46	DIODE MA110					
D835	8-719-109-89	DIODE RD5.6ES-B2					
D836	8-719-977-69	DIODE DTZ24B					
D837	8-719-404-46	DIODE MA110					
D838	8-719-404-46	DIODE MA110					
D1601	8-719-105-XX	DIODE RD6.2M-B1					
D1602	8-719-404-46	DIODE MA110					
D1603	8-719-977-61	DIODE DTZ20B					
D1604	8-719-404-46	DIODE MA110					
D1605	8-719-404-46	DIODE MA110					
D1606	8-719-981-00	DIODE ERC81-004					
D1607	8-719-981-00	DIODE ERC81-004					
D1608	8-719-977-02	DIODE DTZ5.6A					
D1609	8-719-977-49	DIODE DTZ15B					
D1610	8-719-404-46	DIODE MA110					
<IC>							
IC501	8-759-909-70	IC CX23025					
IC502	8-759-100-60	IC UPC1377C					
IC503	8-759-801-98	IC LA7830					
IC504	8-759-929-62	IC MCT812CT					
IC505	8-759-009-51	IC MC14538BF					
IC831	8-759-509-29	IC XRU4011BF					
IC832	8-759-509-37	IC XRU4070BF					
IC833	8-759-009-51	IC MC14538BF					
IC1601	8-759-509-91	IC XRA10393F					
<COIL>							
L501	1-410-093-11	INDUCTOR 33MMH					
L502	1-410-665-31	INDUCTOR 15UH					
L503	1-424-625-11	COIL, CHOKE (PMC) 381.4UH					
L506	1-412-530-31	INDUCTOR 27UH					
L1601	1-459-155-00	COIL (WITH CORE) 45UH					
L1602	1-424-626-12	COIL, CHOKE 390UH					
L1603	1-410-397-21	FERRITE BEAD INDUCTOR					
<TRANSISTOR>							
Q501	8-729-901-01	TRANSISTOR DTC144EK					
Q502	8-729-901-01	TRANSISTOR DTC144EK					
Q503	8-729-901-06	TRANSISTOR DTA144EK					
Q504	8-729-901-01	TRANSISTOR DTC144EK					
Q505	8-729-920-74	TRANSISTOR 2SC2412K-QR					
Q506	8-729-901-01	TRANSISTOR DTC144EK					
Q507	8-729-901-01	TRANSISTOR DTC144EK					
Q508	8-729-920-74	TRANSISTOR 2SC2412K-QR					
Q509	8-729-920-74	TRANSISTOR 2SC2412K-QR					
Q510	8-729-901-06	TRANSISTOR DTA144EK					
Q511	8-729-901-01	TRANSISTOR DTC144EK					
Q512	8-729-920-74	TRANSISTOR 2SC2412K-QR					
Q513	8-729-216-22	TRANSISTOR 2SA1162-G					
Q514	8-729-216-22	TRANSISTOR 2SA1162-G					
Q515	8-729-313-42	TRANSISTOR 2SD1134-C					
Q516	8-729-901-01	TRANSISTOR DTC144EK					
Q517	8-729-901-01	TRANSISTOR DTC144EK					
Q518	8-729-920-74	TRANSISTOR 2SC2412K-QR					
Q519	8-729-920-74	TRANSISTOR 2SC2412K-QR					
Q525	8-729-920-74	TRANSISTOR 2SC2412K-QR					

D

REF. NO.	PART NO.	DESCRIPTION	REMARK	REF. NO.	PART NO.	DESCRIPTION	REMARK
Q532	8-729-920-74	TRANSISTOR 2SC2412K-QR		R537	1-215-867-00	METAL OXIDE 470 5%	1W F
Q533	8-729-920-74	TRANSISTOR 2SC2412K-QR		R538	1-216-095-00	METAL GLAZE 82K 5%	1/10W
Q833	8-729-216-22	TRANSISTOR 2SA1162-G		R539	1-216-095-00	METAL GLAZE 82K 5%	1/10W
Q834	8-729-920-74	TRANSISTOR 2SC2412K-QR		R540	1-216-101-00	METAL GLAZE 150K 5%	1/10W
Q835	8-729-920-74	TRANSISTOR 2SC2412K-QR		R541	1-216-063-00	METAL GLAZE 3.9K 5%	1/10W
Q836	8-729-309-08	TRANSISTOR 2SC1890A		R542	1-216-075-00	METAL GLAZE 12K 5%	1/10W
Q1601	8-729-920-74	TRANSISTOR 2SC2412K-QR		R543	1-216-065-00	METAL GLAZE 4.7K 5%	1/10W
Q1602	8-729-920-74	TRANSISTOR 2SC2412K-QR		R544	1-216-101-00	METAL GLAZE 150K 5%	1/10W
Q1603	8-729-920-74	TRANSISTOR 2SC2412K-QR		R545	1-216-041-00	METAL GLAZE 470 5%	1/10W
Q1604	8-729-216-22	TRANSISTOR 2SA1162-G		R546	1-216-091-00	METAL GLAZE 56K 5%	1/10W
Q1605	8-729-119-80	TRANSISTOR 2SC2688-LK		R547	1-216-121-00	METAL GLAZE 1M 5%	1/10W
Q1606	8-729-133-42	TRANSISTOR 2SC2334-L		R548	1-216-107-00	METAL GLAZE 270K 5%	1/10W
Q1607	8-729-920-74	TRANSISTOR 2SC2412K-QR		R549	1-216-101-00	METAL GLAZE 150K 5%	1/10W
Q1608	8-729-920-74	TRANSISTOR 2SC2412K-QR		R550	1-216-356-00	METAL OXIDE 3.9 5%	1W F
Q1609	8-729-920-74	TRANSISTOR 2SC2412K-QR		R552	1-216-061-00	METAL GLAZE 3.3K 5%	1/10W
Q1610	8-729-920-74	TRANSISTOR 2SC2412K-QR		R553	1-216-087-11	METAL GLAZE 39K 5%	1/10W
Q1611	8-729-920-74	TRANSISTOR 2SC2412K-QR		R554	1-216-073-00	METAL GLAZE 10K 5%	1/10W
Q1612	8-729-920-74	TRANSISTOR 2SC2412K-QR		R555	1-216-077-00	METAL GLAZE 15K 5%	1/10W
Q1613	8-729-920-74	TRANSISTOR 2SC2412K-QR		R557	1-216-057-00	METAL GLAZE 2.2K 5%	1/10W
Q1614	8-729-920-74	TRANSISTOR 2SC2412K-QR		R558	1-216-049-00	METAL GLAZE 1K 5%	1/10W
Q1615	8-729-216-22	TRANSISTOR 2SA1162-G		R559	1-216-065-00	METAL GLAZE 4.7K 5%	1/10W
Q1616	8-729-216-22	TRANSISTOR 2SA1162-G		R560	1-216-037-00	METAL GLAZE 330 5%	1/10W
Q1617	8-729-216-22	TRANSISTOR 2SA1162-G		R561	1-216-081-00	METAL GLAZE 22K 5%	1/10W
Q1618	8-729-216-22	TRANSISTOR 2SA1162-G		R562	1-216-053-00	METAL GLAZE 1.5K 5%	1/10W
<RESISTOR>				R563	1-216-061-00	METAL GLAZE 3.3K 5%	1/10W
JR510	1-216-295-00	METAL GLAZE 0 5%	1/10W	R564	1-249-415-11	CARBON 680 5%	1/4W F
R501	1-216-089-00	METAL GLAZE 47K 5%	1/10W	R565	1-216-059-00	METAL GLAZE 2.7K 5%	1/10W
R502	1-216-089-00	METAL GLAZE 47K 5%	1/10W	R566	1-216-025-00	METAL GLAZE 100 5%	1/10W
R503	1-249-437-11	CARBON 47K 5%	1/4W F	R567	1-216-095-00	METAL GLAZE 82K 5%	1/10W
R504	1-216-073-00	METAL GLAZE 10K 5%	1/10W	R568	1-216-063-00	METAL GLAZE 3.9K 5%	1/10W
R505	1-249-393-11	CARBON 10 5%	1/4W F	R569	1-216-063-00	METAL GLAZE 3.9K 5%	1/10W
R506	1-216-071-00	METAL GLAZE 8.2K 5%	1/10W	R570	1-216-093-00	METAL GLAZE 68K 5%	1/10W
R507	1-216-059-00	METAL GLAZE 2.7K 5%	1/10W	R571	1-216-089-00	METAL GLAZE 47K 5%	1/10W
R508	1-216-085-00	METAL GLAZE 33K 5%	1/10W	R572	1-216-095-00	METAL GLAZE 82K 5%	1/10W
R509	1-216-687-11	METAL CHIP 33K 0.50%	1/10W	R573	1-216-063-00	METAL GLAZE 3.9K 5%	1/10W
R510	1-216-683-11	METAL CHIP 22K 0.50%	1/10W	R574	1-216-063-00	METAL GLAZE 3.9K 5%	1/10W
R511	1-216-675-11	METAL CHIP 10K 0.50%	1/10W	R575	1-216-105-00	METAL GLAZE 220K 5%	1/10W
R512	1-218-761-11	METAL CHIP 240K 0.50%	1/10W	R576	1-216-109-00	METAL GLAZE 330K 5%	1/10W
R513	1-216-065-00	METAL GLAZE 4.7K 5%	1/10W	R577	1-216-105-00	METAL GLAZE 220K 5%	1/10W
R514	1-218-754-11	METAL CHIP 120K 0.50%	1/10W	R578	1-249-457-11	CARBON 6.8 5%	1/4W F
R515	1-216-081-00	METAL GLAZE 22K 5%	1/10W	R579	1-249-457-11	CARBON 6.8 5%	1/4W F
R516	1-216-073-00	METAL GLAZE 10K 5%	1/10W	R591	1-216-063-00	METAL GLAZE 3.9K 5%	1/10W
R517	1-216-107-00	METAL CHIP 270K 0.50%	1/10W	R592	1-216-033-00	METAL GLAZE 220 5%	1/10W
R518	1-249-422-11	CARBON 2.7K 5%	1/4W F	R831	1-216-049-00	METAL GLAZE 1K 5%	1/10W
R519	1-216-085-00	METAL GLAZE 33K 5%	1/10W	R832	1-216-075-00	METAL GLAZE 12K 5%	1/10W
R520	1-216-677-11	METAL CHIP 12K 0.50%	1/10W	R833	1-216-065-00	METAL GLAZE 4.7K 5%	1/10W
R521	1-216-067-00	METAL GLAZE 5.6K 5%	1/10W	R834	1-216-059-00	METAL GLAZE 2.7K 5%	1/10W
R522	1-216-107-00	METAL GLAZE 270K 5%	1/10W	R835	1-216-081-00	METAL GLAZE 22K 5%	1/10W
R523	1-216-081-00	METAL GLAZE 22K 5%	1/10W	R836	1-216-049-00	METAL GLAZE 1K 5%	1/10W
R524	1-216-049-00	METAL GLAZE 1K 5%	1/10W	R837	1-216-075-00	METAL GLAZE 12K 5%	1/10W
R525	1-216-434-11	METAL OXIDE 1.8K 5%	1W F	R838	1-216-049-00	METAL GLAZE 1K 5%	1/10W
R526	1-216-079-00	METAL GLAZE 18K 5%	1/10W	R839	1-216-061-00	METAL GLAZE 3.3K 5%	1/10W
R527	1-249-437-11	CARBON 47K 5%	1/4W F	R840	1-216-097-00	METAL GLAZE 100K 5%	1/10W
R528	1-216-073-00	METAL GLAZE 10K 5%	1/10W	R841	1-216-093-00	METAL GLAZE 68K 5%	1/10W
R529	1-216-073-00	METAL GLAZE 10K 5%	1/10W	R842	1-216-093-00	METAL GLAZE 68K 5%	1/10W
R530	1-216-089-00	METAL GLAZE 47K 5%	1/10W	R843	1-216-065-00	METAL GLAZE 4.7K 5%	1/10W
R531	1-216-089-00	METAL GLAZE 47K 5%	1/10W	R844	1-216-077-00	METAL GLAZE 15K 5%	1/10W
R532	1-216-097-00	METAL GLAZE 100K 5%	1/10W	R847	1-216-049-00	METAL GLAZE 1K 5%	1/10W
R533	1-216-089-00	METAL GLAZE 47K 5%	1/10W	R850	1-216-085-00	METAL GLAZE 33K 5%	1/10W
R534	1-216-097-00	METAL GLAZE 100K 5%	1/10W	R851	1-216-669-11	METAL CHIP 5.6K 0.50%	1/10W
R535	1-216-053-00	METAL GLAZE 1.5K 5%	1/10W	R852	1-216-675-11	METAL CHIP 10K 0.50%	1/10W
R536	1-212-881-11	FUSIBLE 100 5%	1/4W F	R853	1-216-105-00	METAL GLAZE 220K 5%	1/10W
				R854	1-218-754-11	METAL CHIP 120K 0.50%	1/10W



The components identified by **■** in this manual have been carefully factory-selected for each set in order to satisfy regulations regarding X-ray radiation. Should replacement be required, replace only with the value originally used.

The components identified by shading and mark **▲** are critical for safety. Replace only with part number specified.

REF. NO.	PART NO.	DESCRIPTION	REMARK	REF. NO.	PART NO.	DESCRIPTION	REMARK
R855	1-216-697-11	METAL CHIP	82K 0.50% 1/10W	R1647	1-216-685-11	METAL CHIP	27K 0.50% 1/10W
R856	1-216-699-11	METAL CHIP	100K 0.50% 1/10W	R1648	1-216-069-00	METAL GLAZE	6.8K 5% 1/10W
R857	1-216-686-11	METAL CHIP	30K 0.50% 1/10W	R1649	1-216-069-00	METAL GLAZE	6.8K 5% 1/10W
R858	1-216-061-00	METAL GLAZE	3.3K 5% 1/10W	R1650	1-216-069-00	METAL GLAZE	6.8K 5% 1/10W
R859	1-216-436-00	METAL OXIDE	3.9K 5% 1W F	R1651	1-216-069-00	METAL GLAZE	6.8K 5% 1/10W
R860	1-216-675-11	METAL CHIP	10K 0.50% 1/10W	R1652	1-216-069-00	METAL GLAZE	6.8K 5% 1/10W
R861	1-216-671-11	METAL CHIP	6.8K 0.50% 1/10W	R1653	1-216-069-00	METAL GLAZE	6.8K 5% 1/10W
R862	1-216-675-11	METAL CHIP	10K 0.50% 1/10W	R1654	1-216-681-11	METAL CHIP	18K 0.50% 1/10W
R863	1-249-435-11	CARBON	33K 5% 1/4W F	R1655	1-216-081-00	METAL GLAZE	22K 5% 1/10W
R1503	1-216-049-00	METAL GLAZE	1K 5% 1/10W	R1656	1-216-643-11	METAL CHIP	470 0.50% 1/10W
R1504	1-216-695-11	METAL CHIP	68K 0.50% 1/10W	R1657	1-216-081-00	METAL GLAZE	22K 5% 1/10W
R1505	1-216-089-00	METAL GLAZE	47K 5% 1/10W	R1658	1-216-063-00	METAL GLAZE	3.9K 5% 1/10W
R1506	1-216-667-11	METAL CHIP	4.7K 0.50% 1/10W	R1659	1-216-049-00	METAL GLAZE	1K 5% 1/10W
R1507	1-216-081-00	METAL GLAZE	22K 5% 1/10W	R1660	1-216-649-11	METAL CHIP	820 0.50% 1/10W
R1508	1-216-073-00	METAL GLAZE	10K 5% 1/10W	R1661	1-216-065-00	METAL GLAZE	4.7K 5% 1/10W
R1509	1-216-065-00	METAL GLAZE	4.7K 5% 1/10W	<VARIABLE RESISTOR>			
R1510	1-249-425-11	CARBON	4.7K 5% 1/4W F	RV501	1-238-019-11	RES, ADJ, CARBON	47K
R1511	1-216-033-00	METAL GLAZE	220 5% 1/10W	RV502	1-238-017-11	RES, ADJ, CARBON	22K
R1512	1-216-049-00	METAL GLAZE	1K 5% 1/10W	RV503	1-241-763-11	RES, ADJ, CERMET	4.7K
R1513	1-216-017-00	METAL GLAZE	47 5% 1/10W	RV504	1-224-250-XX	RES, ADJ, METAL GLAZE	2.2K
R1519	1-216-031-00	METAL GLAZE	180 5% 1/10W	RV505	1-238-009-11	RES, ADJ, CARBON	220
R1520	1-216-053-00	METAL GLAZE	1.5K 5% 1/10W	RV506	1-238-012-11	RES, ADJ, CARBON	1K
R1601	1-216-685-11	METAL CHIP	27K 0.50% 1/10W	RV507	1-238-013-11	RES, ADJ, CARBON	2.2K
R1602	1-216-681-11	METAL CHIP	18K 0.50% 1/10W	RV508	1-238-012-11	RES, ADJ, CARBON	1K
R1603	1-216-671-11	METAL CHIP	6.8K 0.50% 1/10W	RV509	1-238-021-11	RES, ADJ, CARBON	220K
R1604	1-249-433-11	CARBON	22K 5% 1/4W F	RV511	1-238-015-11	RES, ADJ, CARBON	4.7K
R1605	1-216-070-00	METAL GLAZE	7.5K 5% 1/10W	RV512	1-238-015-11	RES, ADJ, CARBON	4.7K
R1606	1-216-070-00	METAL GLAZE	7.5K 5% 1/10W	RV514	1-238-019-11	RES, ADJ, CARBON	47K
R1607	1-216-071-00	METAL GLAZE	8.2K 5% 1/10W	RV515	1-238-021-11	RES, ADJ, CARBON	220K
R1608	1-216-065-00	METAL GLAZE	4.7K 5% 1/10W	RV516	1-241-763-11	RES, ADJ, CERMET	4.7K
R1609	1-216-069-00	METAL GLAZE	6.8K 5% 1/10W	RV831	1-228-997-00	RES, ADJ, METAL GLAZE	100K
R1610	1-216-057-00	METAL GLAZE	2.2K 5% 1/10W	RV832	1-241-764-11	RES, ADJ, CERMET	10K
R1611	1-216-057-00	METAL GLAZE	2.2K 5% 1/10W	■RV833▲		RES, ADJ, CERMET	
R1612	1-215-913-11	METAL OXIDE	220 5% 3W F	RV1601	1-241-700-11	RES, ADJ, CERMET	2.2K
R1613	1-216-025-00	METAL GLAZE	100 5% 1/10W	RV1602	1-238-012-11	RES, ADJ, CARBON	1K
R1614	1-216-067-00	METAL GLAZE	5.6K 5% 1/10W	■RV1603▲		RES, ADJ, CERMET	
R1615	1-216-657-11	METAL CHIP	1.8K 0.50% 1/10W	<RELAY>			
R1616	1-216-629-11	METAL CHIP	120 0.50% 1/10W	RY1601	1-515-481-21	RELAY (G2R-212P-V)	
R1617	1-216-659-11	METAL CHIP	2.2K 0.50% 1/10W	<TRANSFORMER>			
R1618	1-216-073-00	METAL GLAZE	10K 5% 1/10W	T1601	1-437-216-11	TRANSFORMER, DRIVE	
R1620	1-216-065-00	METAL GLAZE	4.7K 5% 1/10W	*****			
R1621	1-216-073-00	METAL GLAZE	10K 5% 1/10W	*A-1371-782-A	HA BOARD, COMPLETE	*****	
R1622	1-216-073-00	METAL GLAZE	10K 5% 1/10W	*4-348-208-00	HOLDER, LED		
R1623	1-216-073-00	METAL GLAZE	10K 5% 1/10W	*4-341-751-01	EYELET EY5		
R1624	1-216-246-00	METAL GLAZE	100K 5% 1/8W	<CONNECTOR>			
R1625	1-216-061-00	METAL GLAZE	3.3K 5% 1/10W	CN001	1-506-478-11	PIN, CONNECTOR	13P
R1626	1-216-065-00	METAL GLAZE	4.7K 5% 1/10W	CN002	1-506-473-11	PIN, CONNECTOR	8P
R1627	1-216-049-00	METAL GLAZE	1K 5% 1/10W	<DIODE>			
R1628	1-216-073-00	METAL GLAZE	10K 5% 1/10W	D001	8-719-920-05	DIODE SLP281C-50	
R1629	1-216-683-11	METAL CHIP	22K 0.50% 1/10W	D002	8-719-109-68	DIODE RD3.6ESB1	
R1630	1-216-683-11	METAL CHIP	22K 0.50% 1/10W				
R1631	1-216-057-00	METAL GLAZE	2.2K 5% 1/10W				
R1632	1-216-042-00	METAL GLAZE	510 5% 1/10W				
R1633	1-216-109-00	METAL GLAZE	330K 5% 1/10W				
R1634	1-216-099-00	METAL GLAZE	120K 5% 1/10W				
R1635	1-216-097-00	METAL GLAZE	100K 5% 1/10W				
R1636	1-216-073-00	METAL GLAZE	10K 5% 1/10W				
R1640	1-216-063-00	METAL GLAZE	3.9K 5% 1/10W				
R1641	1-216-073-00	METAL GLAZE	10K 5% 1/10W				
R1642	1-216-073-00	METAL GLAZE	10K 5% 1/10W				
R1643	1-216-069-00	METAL GLAZE	6.8K 5% 1/10W				
R1644	1-216-069-00	METAL GLAZE	6.8K 5% 1/10W				
R1645	1-216-073-00	METAL GLAZE	10K 5% 1/10W				
R1646	1-216-073-00	METAL GLAZE	10K 5% 1/10W				



REF. NO.	PART NO.	DESCRIPTION	REMARK	REF. NO.	PART NO.	DESCRIPTION	REMARK
<RESISTOR>							
JW009	1-216-295-00	METAL GLAZE	0 5% 1/10W	C1109	1-163-031-11	CERAMIC CHIP 0.01MF	50V
JW024	1-216-295-00	METAL GLAZE	0 5% 1/10W	C1110	1-163-117-00	CERAMIC CHIP 100PF	5% 50V
R001	1-247-713-11	CARBON	1K 5% 1/4W	C1111	1-163-018-00	CERAMIC CHIP 0.0056MF	10% 50V
R002	1-216-295-00	METAL GLAZE	0 5% 1/10W	C1112	1-126-160-11	ELECT 1MF	20% 50V
R003	1-216-295-00	METAL GLAZE	0 5% 1/10W	C1113	1-163-119-00	CERAMIC CHIP 120PF	5% 50V
R004	1-216-081-00	METAL GLAZE	22K 5% 1/10W	C1114	1-163-103-00	CERAMIC CHIP 27PF	5% 50V
<VARIABLE RESISTOR>				C1115	1-164-004-11	CERAMIC CHIP 0.1MF	10% 25V
RV001	1-241-846-11	RES, VAR, CARBON 20K		C1116	1-163-114-00	CERAMIC CHIP 75PF	5% 50V
RV002	1-241-846-11	RES, VAR, CARBON 20K		C1117	1-124-589-11	ELECT 47MF	20% 16V
RV003	1-241-845-11	RES, VAR, CARBON 20K		C1118	1-164-004-11	CERAMIC CHIP 0.1MF	10% 25V
RV004	1-241-845-11	RES, VAR, CARBON 20K		C1119	1-163-020-00	CERAMIC CHIP 0.0082MF	10% 50V
RV005	1-241-845-11	RES, VAR, CARBON 20K		C1120	1-163-097-00	CERAMIC CHIP 15PF	5% 50V
RV006	1-241-845-11	RES, VAR, CARBON 20K		C1121	1-163-097-00	CERAMIC CHIP 15PF	5% 50V
RV007	1-226-773-11	RES, ADJ, METAL GLAZE 22K		C1122	1-163-222-11	CERAMIC CHIP 5PF	0.25PF 50V
RV008	1-226-773-11	RES, ADJ, METAL GLAZE 22K		C1123	1-163-097-00	CERAMIC CHIP 15PF	5% 50V
RV009	1-226-773-11	RES, ADJ, METAL GLAZE 22K		C1130	1-163-097-00	CERAMIC CHIP 15PF	5% 50V
RV010	1-226-773-11	RES, ADJ, METAL GLAZE 22K		C1131	1-163-097-00	CERAMIC CHIP 15PF	5% 50V
RV011	1-226-773-11	RES, ADJ, METAL GLAZE 22K		<CONNECTOR>			
RV012	1-226-773-11	RES, ADJ, METAL GLAZE 22K		CN1101	*1-565-488-11	CONNECTOR, BOARD TO BOARD 12P	
<SWITCH>				<DIODE>			
S001	1-554-419-00	SWITCH, PUSH (1 KEY)		D1101	8-719-404-46	DIODE MA110	
S002	1-554-419-00	SWITCH, PUSH (1 KEY)		D1102	8-719-404-46	DIODE MA110	
S003	1-554-419-00	SWITCH, PUSH (1 KEY)		<IC>			
S004	1-554-419-00	SWITCH, PUSH (1 KEY)		IC1101	8-752-056-67	IC CXA1214P	
S005	1-554-419-00	SWITCH, PUSH (1 KEY)		<COIL>			
S006	1-554-419-00	SWITCH, PUSH (1 KEY)		L1101	1-408-411-00	INDUCTOR 15UH	
*****				L1102	1-404-496-00	COIL	
*1-641-724-11	X BOARD	*****		L1103	1-404-496-00	COIL	
<CONNECTOR>				L1104	1-408-411-00	INDUCTOR 15UH	
CN21	*1-564-518-11	PLUG, CONNECTOR 3P		L1110	1-412-008-31	INDUCTOR CHIP 15UH	
<DIOE>				L1111	1-412-008-31	INDUCTOR CHIP 15UH	
D21	8-719-023-78	DIODE SEL3810DLC05		<TRANSISTOR>			
D22	8-719-023-78	DIODE SEL3810DLC05		Q1101	8-729-216-22	TRANSISTOR 2SA1162-G	
D23	8-719-023-78	DIODE SEL3810DLC05		Q1102	8-729-920-74	TRANSISTOR 2SC2412K-QR	
*****				Q1103	8-729-216-22	TRANSISTOR 2SA1162-G	
*A-1394-368-A	S BOARD, COMPLETE	*****		Q1104	8-729-216-22	TRANSISTOR 2SA1162-G	
3-710-578-01	COVER, VOLUME, 6 MOLD			Q1105	8-729-901-01	TRANSISTOR DTC144EK	
<CAPACITOR>				Q1106	8-729-901-01	TRANSISTOR DTC144EK	
C1101	1-163-119-00	CERAMIC CHIP 120PF	5% 50V	Q1107	8-729-109-44	TRANSISTOR 2SK94-X4	
C1102	1-164-004-11	CERAMIC CHIP 0.1MF	10% 25V	Q1108	8-729-920-74	TRANSISTOR 2SC2412K-QR	
C1103	1-124-589-11	ELECT 47MF	20% 16V	<RESISTOR>			
C1104	1-163-031-11	CERAMIC CHIP 0.01MF	5% 50V	R1101	1-216-053-00	METAL GLAZE 1.5K 5% 1/10W	
C1105	1-163-114-00	CERAMIC CHIP 75PF	5% 50V	R1102	1-216-067-00	METAL GLAZE 5.6K 5% 1/10W	
C1106	1-163-101-00	CERAMIC CHIP 22PF	5% 50V	R1103	1-216-059-00	METAL GLAZE 2.7K 5% 1/10W	
C1107	1-164-004-11	CERAMIC CHIP 0.1MF	10% 25V	R1104	1-216-073-00	METAL GLAZE 10K 5% 1/10W	
C1108	1-163-119-00	CERAMIC CHIP 120PF	5% 50V	R1105	1-216-031-00	METAL GLAZE 180 5% 1/10W	
				R1106	1-216-059-00	METAL GLAZE 2.7K 5% 1/10W	
				R1107	1-216-071-00	METAL GLAZE 8.2K 5% 1/10W	
				R1108	1-216-039-00	METAL GLAZE 390 5% 1/10W	
				R1109	1-216-063-00	METAL GLAZE 3.9K 5% 1/10W	
				R1110	1-216-069-00	METAL GLAZE 6.8K 5% 1/10W	

PVM-9041QM/9044QM

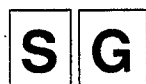

The components identified by **X** in this manual have been carefully factory-selected for each set in order to satisfy regulations regarding X-ray radiation. Should replacement be required, replace only with the value originally used.

The components identified by shading and mark **Δ** are critical for safety. Replace only with part number specified.

REF. NO.	PART NO.	DESCRIPTION	REMARK
R1111	1-216-065-00	METAL GLAZE 4.7K 5%	1/10W
R1112	1-216-063-00	METAL GLAZE 3.9K 5%	1/10W
R1113	1-216-069-00	METAL GLAZE 6.8K 5%	1/10W
R1114	1-216-055-00	METAL GLAZE 1.8K 5%	1/10W
R1115	1-216-061-00	METAL GLAZE 3.3K 5%	1/10W
R1116	1-216-069-00	METAL GLAZE 6.8K 5%	1/10W
R1117	1-216-061-00	METAL GLAZE 3.3K 5%	1/10W
R1118	1-216-073-00	METAL GLAZE 10K 5%	1/10W
R1119	1-216-049-00	METAL GLAZE 1K 5%	1/10W
R1120	1-216-097-00	METAL GLAZE 100K 5%	1/10W
R1121	1-216-121-00	METAL GLAZE 1M 5%	1/10W
R1122	1-216-039-00	METAL GLAZE 390 5%	1/10W
R1123	1-216-065-00	METAL GLAZE 4.7K 5%	1/10W
R1124	1-216-029-00	METAL GLAZE 150 5%	1/10W
R1125	1-216-029-00	METAL GLAZE 150 5%	1/10W
R1126	1-216-053-00	METAL GLAZE 1.5K 5%	1/10W
R1127	1-216-043-00	METAL GLAZE 560 5%	1/10W
R1128	1-216-049-00	METAL GLAZE 1K 5%	1/10W
R1129	1-216-091-00	METAL GLAZE 56K 5%	1/10W
R1130	1-216-295-00	METAL GLAZE 0 5%	1/10W
R1131	1-216-073-00	METAL GLAZE 10K 5%	1/10W
R1132	1-216-073-00	METAL GLAZE 10K 5%	1/10W
R1133	1-216-073-00	METAL GLAZE 10K 5%	1/10W
R1134	1-216-091-00	METAL GLAZE 56K 5%	1/10W

<VARIABLE RESISTOR>

RV1101	1-238-015-11	RES, ADJ, CARBON 4.7K
RV1102	1-238-013-11	RES, ADJ, CARBON 2.2K

<TRANSISTOR>

T1101	1-404-584-11	COIL
-------	--------------	------

G BOARD (SOPS-1021)

Δ 4-812-134-11 RIVET NYLON, 3.5φ

<CAPACITOR>

C601	Δ 1-136-889-11	METALIZED FILM 0.22MF	20%	250V
C602	Δ 1-136-889-11	METALIZED FILM 0.22MF	20%	250V
C603	Δ 1-161-973-51	CERAMIC 220PF	10%	400V
C604	Δ 1-161-973-51	CERAMIC 220PF	10%	400V
C605	Δ 1-161-973-51	CERAMIC 220PF	10%	400V
C608	Δ 1-161-742-51	CERAMIC 0.0022MF	20%	400V
C609	Δ 1-161-742-51	CERAMIC 0.0022MF	20%	400V
C610	Δ 1-125-724-11	ELECT 180MF	20%	400V
C611	Δ 1-136-206-21	METALIZED FILM 0.033MF	10%	630V
C612	Δ 1-124-910-51	ELECT 47MF	20%	50V
C613	Δ 1-137-190-91	METALIZED FILM 0.22MF	5%	50V
C614	Δ 1-137-190-91	METALIZED FILM 0.22MF	5%	50V
C615	Δ 1-130-471-91	PE TEREPHTHALATE 0.001MF	5%	50V
C651	Δ 1-161-925-11	CERAMIC 100PF B	10%	500V
C652	Δ 1-128-486-51	ELECT 680MF	20%	50V
C653	Δ 1-128-485-51	ELECT 220MF	20%	50V
C654	Δ 1-130-483-91	PE TEREPHTHALATE 0.01MF	5%	50V

<CONNECTOR>

CN610	Δ 1-560-436-11	HORIZONTAL PIN ASSY 3P
CN651	Δ 1-564-518-11	PLUG, CONNECTOR 3P

REF. NO.	PART NO.	DESCRIPTION	REMARK
<DIODE>			
D201	Δ 8-719-971-08	DIODE ESAC39M 06C	
D601	Δ 8-719-510-27	DIODE D3SB60	
D602	Δ 8-719-921-20	DIODE 1SS119TD	
D603	Δ 8-719-981-47	DIODE ERA38-06TP1	
D604	Δ 8-719-981-47	DIODE ERA38-06TP1	
D605	Δ 8-719-113-44	DIODE RD20ES-T1B3	
D651	Δ 8-719-971-08	DIODE ESAC39M 06C	
<IC>			
IC601	Δ 1-809-086-12	HIC CH-1018	
IC651	Δ 8-759-908-15	IC TL431CLP	
PH601	Δ 8-759-045-81	IC TLP732GR-LF2	
<COIL>			
L601	Δ 1-424-616-11	TRANSFORMER, LINE FILTER	
L602	Δ 1-424-574-11	L.F.T	
L651	Δ 1-424-255-41	COIL, CHOKE (MOLDE) 10UH	
L652	Δ 1-424-615-11	COIL, CHOKE	
<TRANSISTOR>			
Q601	Δ 8-729-322-18	TRANSISTOR 2SK1402A	
<RESISTOR>			
R601	Δ 1-205-940-51	CEMENT 1.5 5%	5W F
R602	Δ 1-205-940-51	CEMENT 1.5 5%	5W F
R603	Δ 1-215-904-11	METAL OXIDE 100K 5%	2W F
R604	Δ 1-215-904-11	METAL OXIDE 100K 5%	2W F
R605	Δ 1-212-865-61	FUSIBLE 22 5%	1/4W F
R606	Δ 1-247-805-91	CARBON 82 5%	1/4W
R607	Δ 1-260-128-91	CARBON 270K 5%	1/2W
R608	Δ 1-260-128-91	CARBON 270K 5%	1/2W
R609	Δ 1-215-904-51	METAL OXIDE 100K 5%	2W F
R610	Δ 1-207-455-11	WIRE 0.22 10%	1/2W
R611	Δ 1-247-789-91	CARBON 18 5%	1/4W
R612	Δ 1-247-795-91	CARBON 33 5%	1/4W
R613	Δ 1-215-904-51	METAL OXIDE 100K 5%	2W F
R614	Δ 1-247-815-91	CARBON 220 5%	1/4W
R651	Δ 1-215-886-51	METAL OXIDE 100 5%	2W F
R652	Δ 1-215-886-51	METAL OXIDE 100 5%	2W F
R653	Δ 1-260-107-91	CARBON 4.7K 5%	1/2W
R654	Δ 1-260-107-91	CARBON 4.7K 5%	1/2W
R655	Δ 1-247-867-91	CARBON 33K 5%	1/4W
R656	Δ 1-247-867-91	CARBON 33K 5%	1/4W
R657	Δ 1-247-837-91	CARBON 1.8K 5%	1/4W
<VARIABLE RESISTOR>			
RV651	Δ 1-237-443-11	RES, ADJ, CARBON 1K	
<TRANSFORMER>			
T601	Δ 1-450-760-11	TRANSFORMER, CONVERTER	

The components identified by shading and mark Δ are critical for safety. Replace only with part number specified.

REF. NO. PART NO. DESCRIPTION REMARK

MISCELLANEOUS

- Δ 1-413-720-21 SWITCHING REGULATOR (SOPS-1021)
- Δ 1-426-043-12 COIL, DEGAUSSING
- Δ 1-451-319-22 DEFLECTION YOKE (Y9FXC)
- 1-452-126-11 MAGNET
- 1-543-925-11 CORE, FERRITE
- 1-544-252-11 SPEAKER
- 1-690-871-11 CABLE (MINI DIN) 8P
- V901 Δ 8-737-151-05 PICTURE TUBE (A20JKU10X) (PVM-9041QM)
- Δ 8-737-651-05 PICTURE TUBE (M20JMP10X) (PVM-9044QM)

ACCESSORIES & PACKING MATERIALS

PART NO. DESCRIPTION REMARK

- Δ 1-590-910-11 CORD SET, POWER (10.0A/250V)
- 1-690-871-11 CABLE (MINI DIN) 8P
- 2-990-241-02 HOLDER (A), PLUG
- *3-170-078-01 HOLDER (B), PLUG
- *3-704-301-01 BAG (STANDARD), PROTECTION
- 3-754-506-21 MANUAL, INSTRUCTION
- 4-034-835-01 PLATE, TALLY
- *4-034-955-01 CUSHION (UPPER) (ASSY)
- *4-034-956-01 CUSHION (LOWER) (ASSY)
- *4-035-784-01 INDIVIDUAL CARTON

PVM-9041QM/9044QM

SONY SERVICE MANUAL

AEP Model
PVM-9041QM
Chassis No. SCC-F09B-A
PVM-9044QM
Chassis No. SCC-F09A-A

SUPPLEMENT-1

INTRODUCTION

- B board : The transistor is changed to the pair transistor (Q189).
The diodes are changed to the three-terminal diodes.
(D185, D186, D187, D188, D191, D390 and D1382)
- D board : The transistors are changed to the pair transistors.
(Q569, Q576, Q579 and Q599)
The diodes are changed to the three-terminal diodes.
(D520, D521, D848, D1620, D1622 and D1623)
- S board : The pattern is modified.

Note)

Before using the circuit board, confirm that the parts number shown below and the parts number of the circuit board which is being used in your set are the same.

Board (Complete No.)	Board Part. No.
B (A-1135-716-A)	1-641-716-15
D (A-1346-018-A)	1-641-717-16
S (A-1394-368-A)	1-641-719-15



TABLE OF CONTENTS

<u>Section</u>	<u>Title</u>	<u>Page</u>
1. DIAGRAMS		
1-1.	Circuit Boards Location	3
1-2.	Printed Wiring Boards and Schematic Diagrams	3
	S Board	4
	D Board	7
	B Board	16
2. ELECTRICAL PARTS LIST	31

(CAUTION)

SHORT CIRCUIT THE ANODE OF THE PICTURE TUBE AND THE ANODE CAP TO THE METAL CHASSIS, CRT SHIELD, OR CARBON PAINTED ON THE CRT, AFTER REMOVING THE ANODE.

WARNING!!

AN ISOLATION TRANSFORMER SHOULD BE USED DURING ANY SERVICE TO AVOID POSSIBLE SHOCK HAZARD, BECAUSE OF LIVE CHASSIS.
THE CHASSIS OF THIS RECEIVER IS DIRECTLY CONNECTED TO THE AC POWER LINE.

SAFETY-RELATED COMPONENT WARNING !!

COMPONENTS IDENTIFIED BY SHADING AND MARK Δ ON THE SCHEMATIC DIAGRAMS, EXPLODED VIEWS AND IN THE PARTS LIST ARE CRITICAL TO SAFE OPERATION. REPLACE THESE COMPONENTS WITH SONY PARTS WHOSE PART NUMBERS APPEAR AS SHOWN IN THIS MANUAL OR IN SUPPLEMENTS PUBLISHED BY SONY. CIRCUIT ADJUSTMENTS THAT ARE CRITICAL TO SAFE OPERATION ARE IDENTIFIED IN THIS MANUAL. FOLLOW THESE PROCEDURES WHENEVER CRITICAL COMPONENTS ARE REPLACED OR IMPROPER OPERATION IS SUSPECTED.

Suppl 1

SECTION 1
DIAGRAMS

S [SECAM DEMODULATION]

1-1. CIRCUITS BOARDS LOCATION

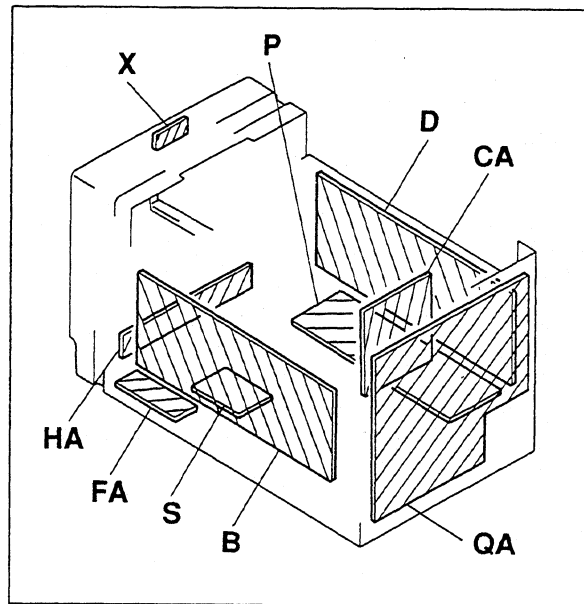

Part replaced (■)	Adjustment (☒)
IC601, IC651, PH602, C655, R653, R655, R656, R657, RV651	RV651 (B+ MAX)
Q1601, Q1602, Q1603, D1601, D1603, D1622, D1623, C1601, C1602, R1601, R1602, R1603, R1604, R1605, R1606, R1607, R1608, R1628, R1629, R1630, RV1601, RV1603	RV1603 (B+ MAX IN DC POWER INPUT MODE)
IC502, Q833, Q834, Q835, Q836, D835, D836, C519, C843, C844, C845, C846, C847, C848, RV833, R523, R850, R851, R852, R853, R854, R855, R856, R857, R858, R859, R861, R862, R863, NL801	R833 (HOLD-DOWN)

- S Board - - Component Side -

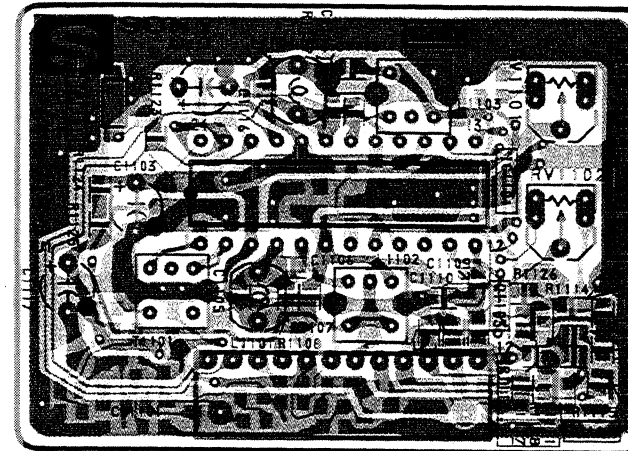

- S Board - - Conductor Side -

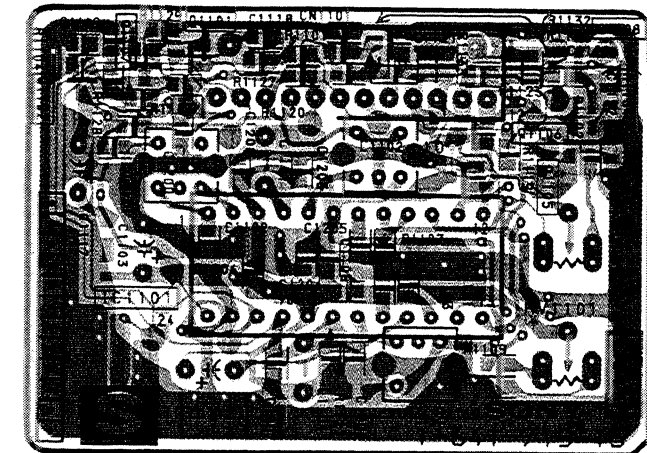

1-2. PRINTED WIRING BOARDS AND SCHEMATIC DIAGRAMS

Note:

- All capacitors are in μF unless otherwise noted. pF: $\mu\mu\text{F}$ 50 WV or less are not indicated except for electrolytic.
- Indication of resistance, which does not have one for rating electrical power, is as follows.

Pitch: 5 mm
Rating electrical power $\frac{1}{4}$ W

- All resistors are in ohms.
- : nonflammable resistor.
- : fusible resistor.
- : internal component.
- : panel designation.
- All variable and adjustable resistors have characteristic curve B, unless otherwise noted.
- The components identified by ☒ in this basic schematic diagram have been carefully factory-selected for each set in order to satisfy regulations regarding X-ray radiation. Should replacement be required, replace only with the value originally used.
- When replacing components identified by ■, make the necessary adjustments indicated. If results do not meet the specified value, change the component identified by ☒ and repeat the adjustment until the specified value is achieved.
- When replacing the part in below table be sure to perform the related adjustment.

Reference information

RESISTOR	: RN	METAL FILM
	: RC	SOLID
	: FPRD	NONFLAMMABLE CARBON
	: FUSE	NONFLAMMABLE FUSIBLE
	: RS	NONFLAMMABLE WIREWOUND
	: RB	NONFLAMMABLE CEMENT
COIL	: LF-8L	MICRO INDUCTOR
CAPACITOR	: TA	TANTALUM
	: PS	STYROL
	: PP	POLYPROPYLENE
	: PT	MYLAR
	: MPS	METALIZED POLYESTER
	: MPP	METALIZED POLYPROPYLENE
	: ALB	BIPOLAR
	: ALT	HIGH TEMPERATURE
	: ALR	HIGH RIPPLE

- : Pattern from the side which enables seeing.
- : Pattern of the rear side.

A
B
C
D
E
F
G
H
I
J

2.1



seeing.

1 2 3 4 5 6 7 8 9 10 11 12 13 14 15

A
B
C
D
E
F
G
H
I
J

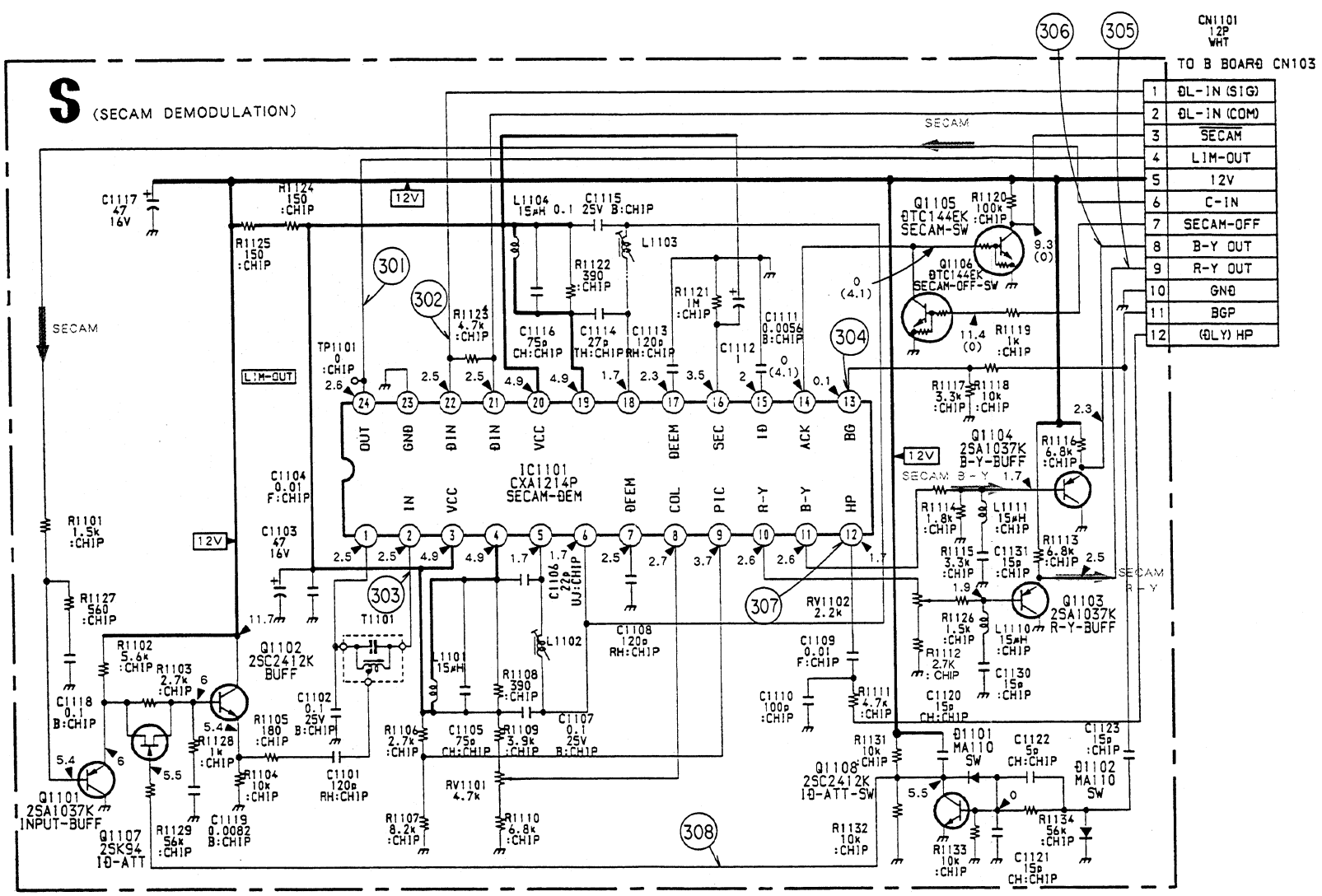

S Board IC1101 CXA1214P

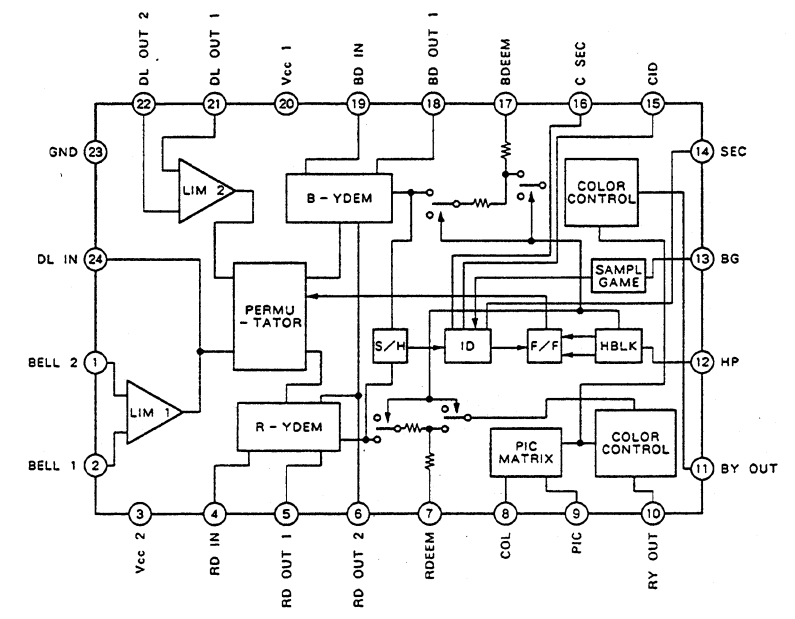

• S BOARD WAVEFORMS

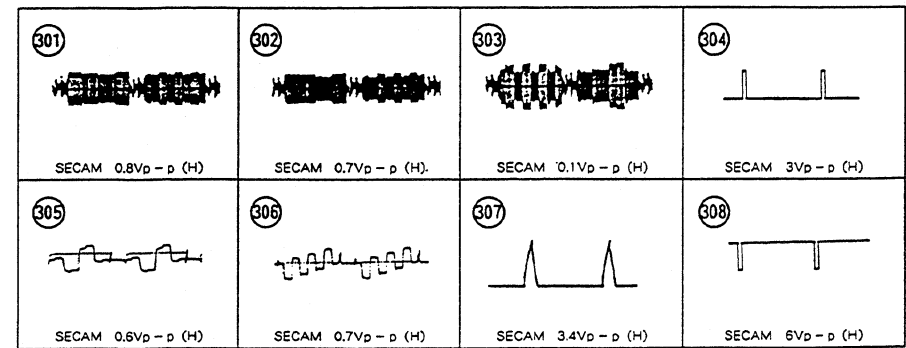

1 2 3 4 5 6 7 8 9 10 11 12 13 14 15 16

A
B
C
D
E
F
G
H
I
J

• D BOARD WAVEFORMS

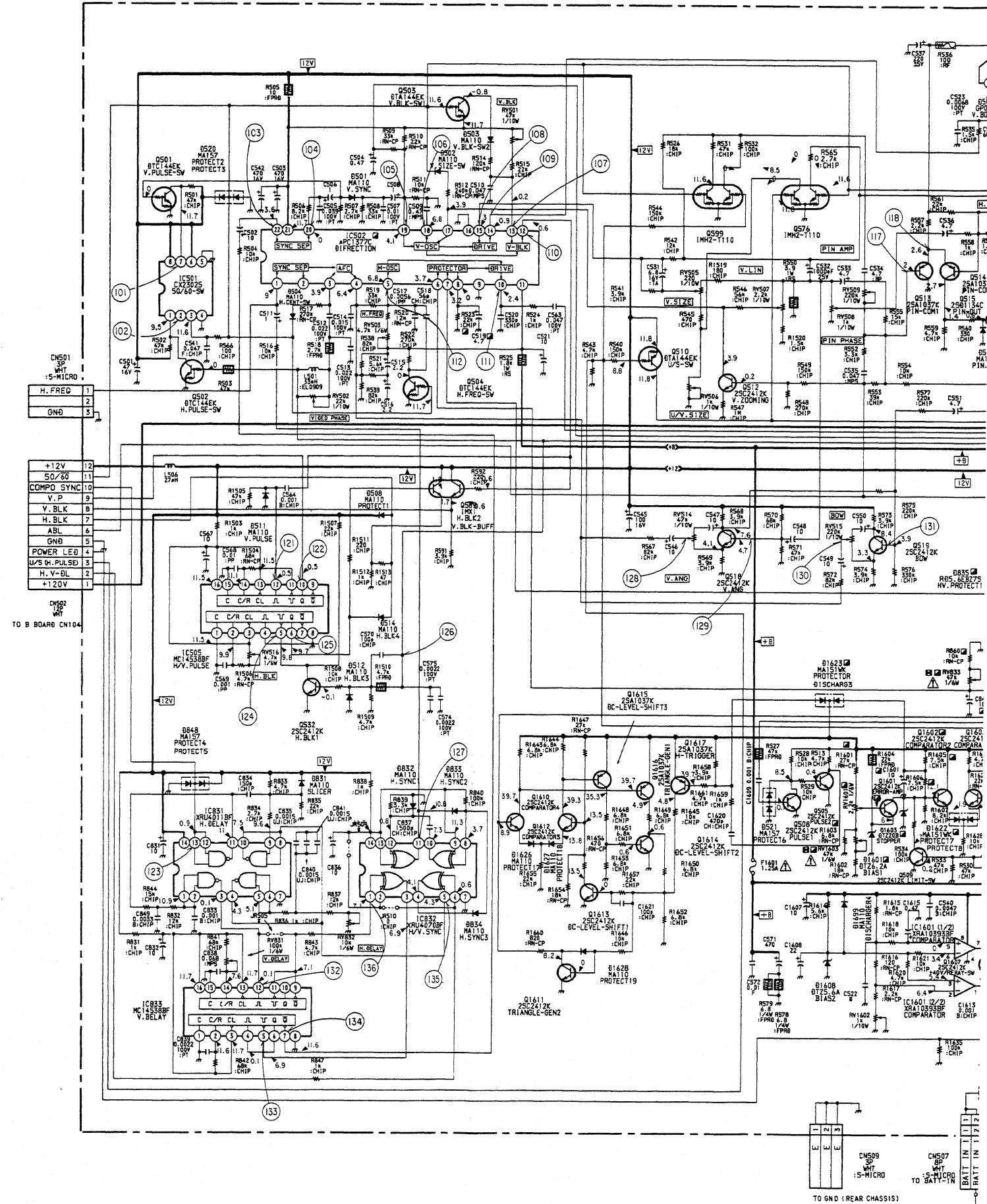
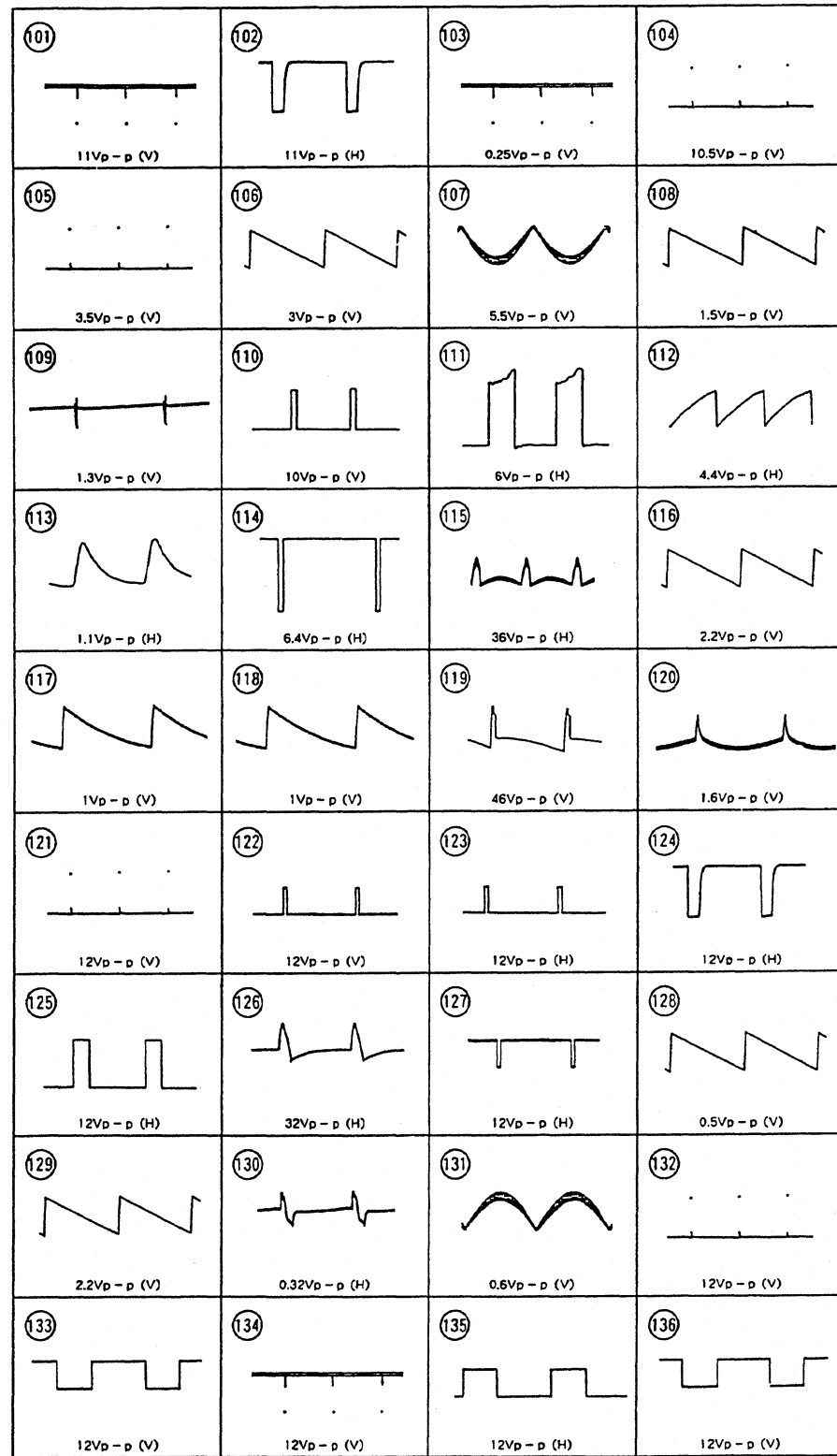

16 17 18 19 20 21 22 23 24 25 26 27 28 29 30

A
B
C
D
E
F
G
H
I
J

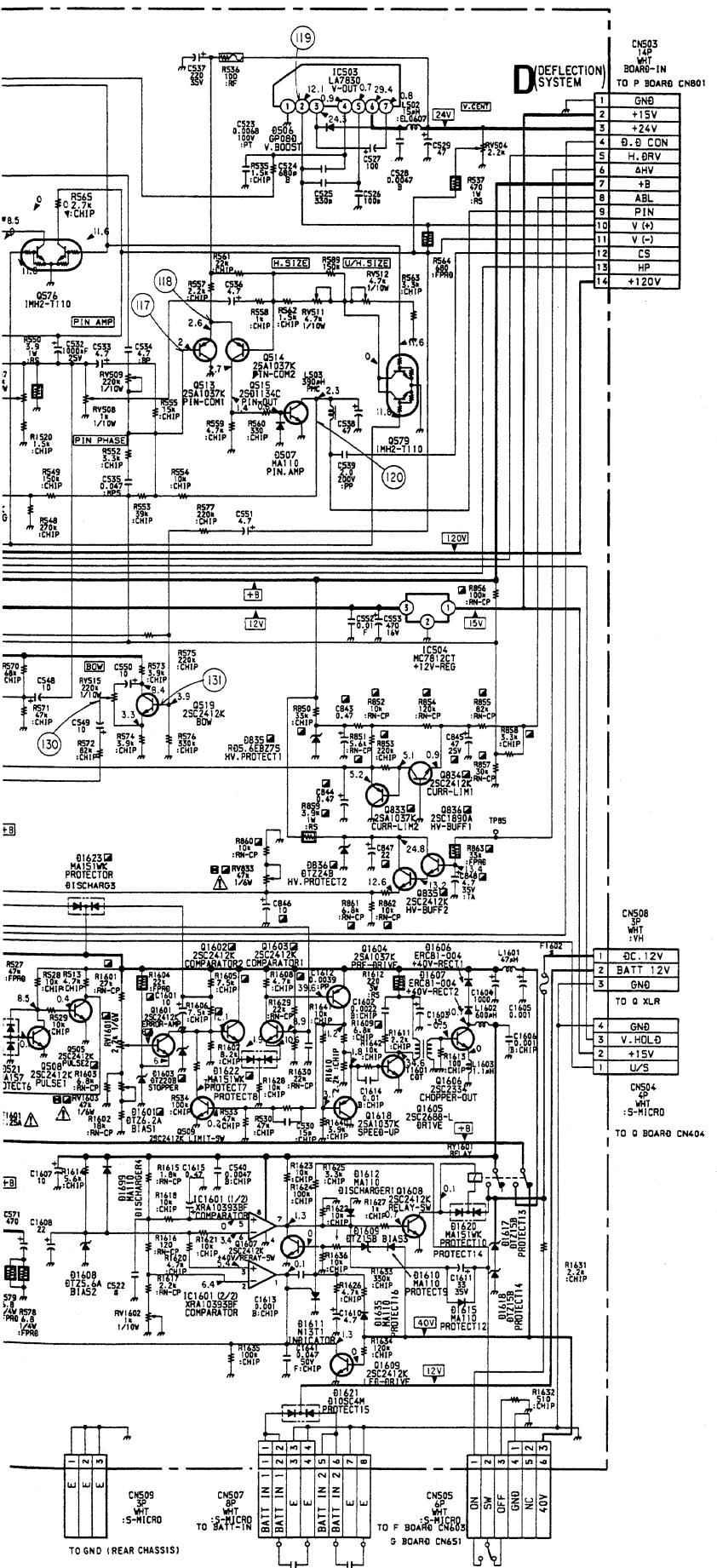

D BOARD IC501 CX23025

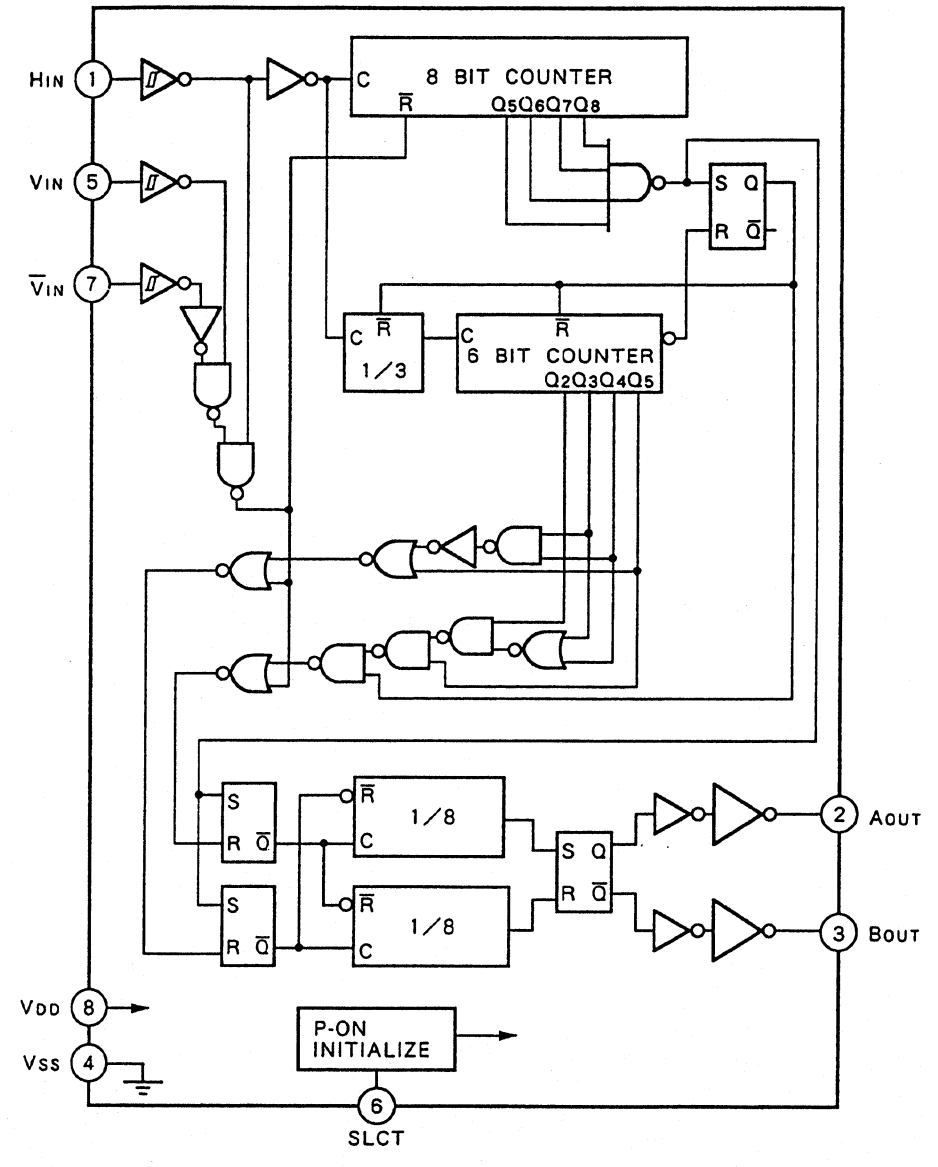

D BOARD IC503 LA7830

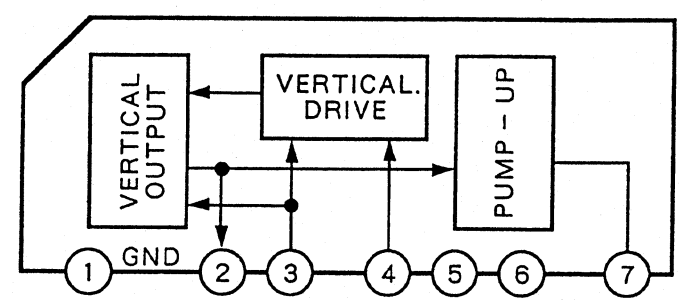

D [DEFLECTION SYSTEM]

- D Board - - Component Side -

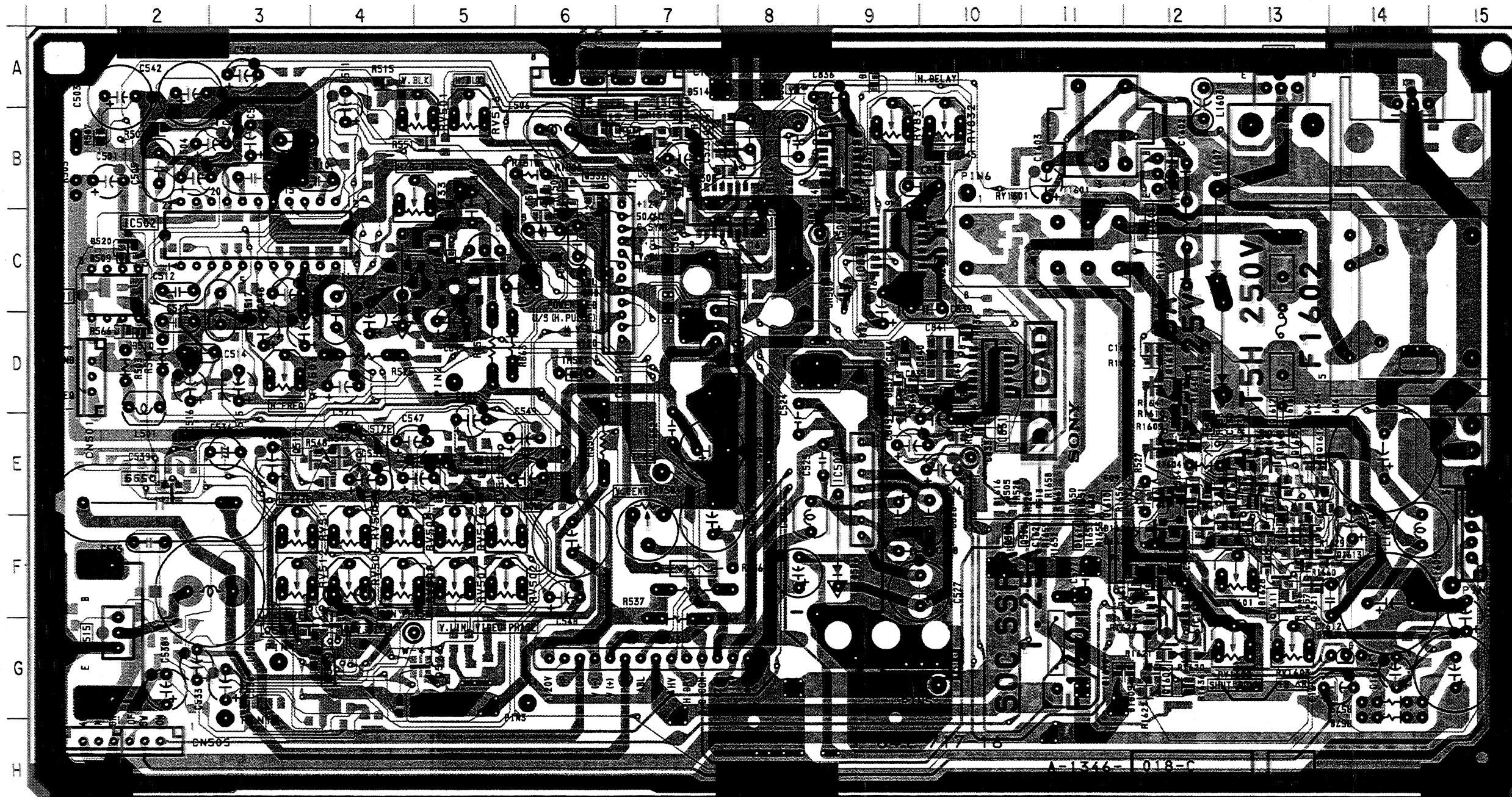

D Board (Component Side)

IC	
IC505	C-8
IC831	D-10
IC832	B-9
IC833	C-9
IC1801	F-12

TRANSISTOR	
Q505	F-12
Q508	F-12
Q509	E-12
Q512	E-4
Q532	B-6
Q576	G-5
Q579	G-4
Q599	E-2
Q1607	G-12
Q1610	E-13
Q1611	F-13
Q1612	E-13
Q1613	F-13
Q1614	F-13
Q1615	E-13
Q1616	E-13
Q1617	E-13
Q1618	D-12

DIODE	
D508	A-6
D512	C-6
D514	A-7
D520	C-2
D521	F-12
D833	A-8
D834	A-9
D836	C-5
D848	D-10
D1609	G-12
D1610	G-10
D1626	F-13
D1627	F-13
D1628	F-13

• [Pattern] : Pattern from the side which enables seeing.
 • [Pattern] : Pattern of the rear side.

- D Board - - Conductor Side -

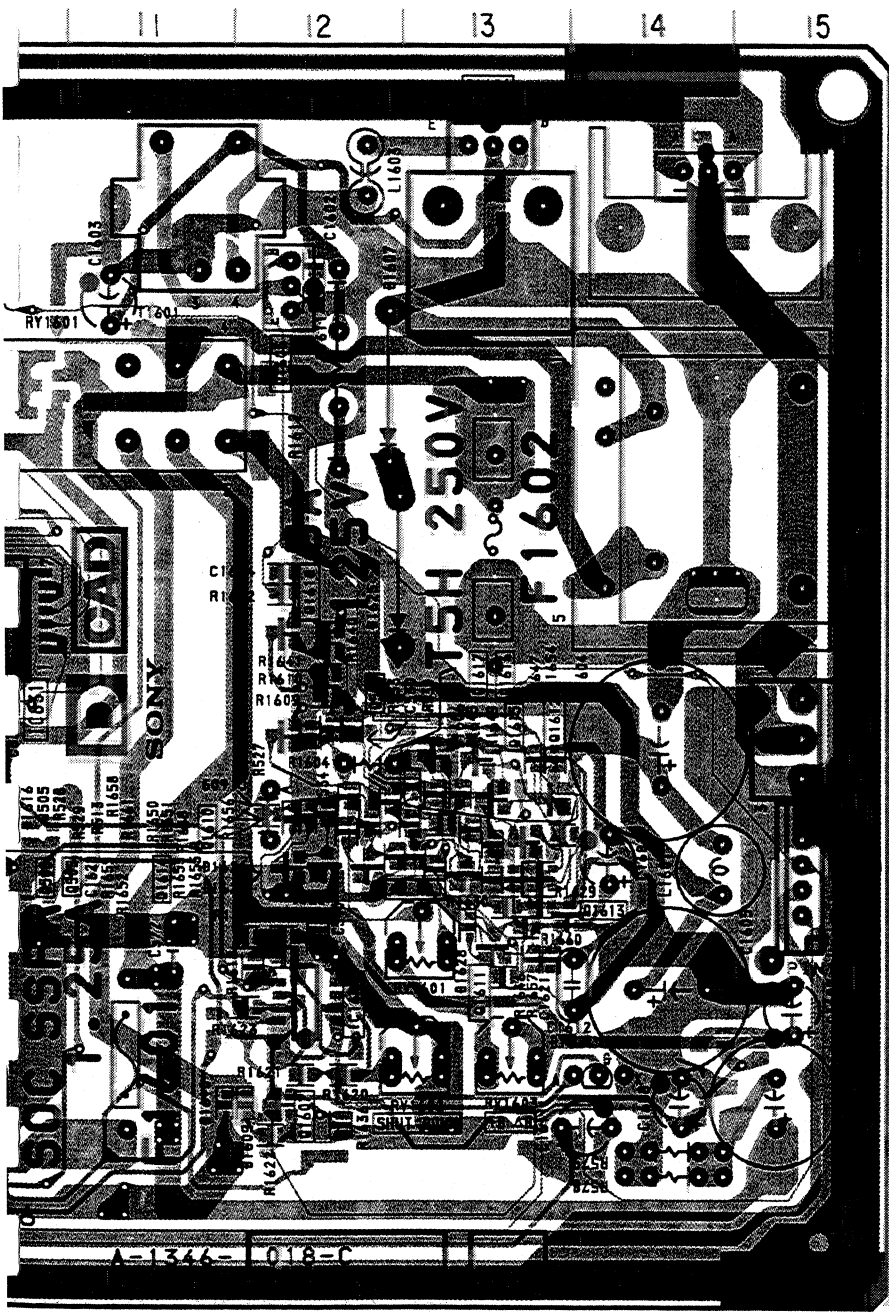

D Board (Component Side)

IC	
IC505	C-8
IC831	D-10
IC832	B-9
IC833	C-9
IC1601	F-12

TRANSISTOR	
Q505	F-12
Q508	F-12
Q509	E-12
Q512	E-4
Q532	B-6
Q576	G-5
Q579	G-4
Q599	E-2
Q1607	G-12
Q1610	E-13
Q1611	F-13
Q1612	E-13
Q1613	F-13
Q1614	F-13
Q1615	E-13
Q1616	E-13
Q1617	E-13
Q1618	D-12

DIODE	
D508	A-6
D512	C-6
D514	A-7
D520	C-2
D521	F-12
D833	A-8
D834	A-9
D836	C-5
D848	D-10
D1609	G-12
D1610	G-10
D1626	F-13
D1627	F-13
D1628	F-13

• [Hatched Pattern] : Pattern from the side which enables seeing.
 • [Dotted Pattern] : Pattern of the rear side.

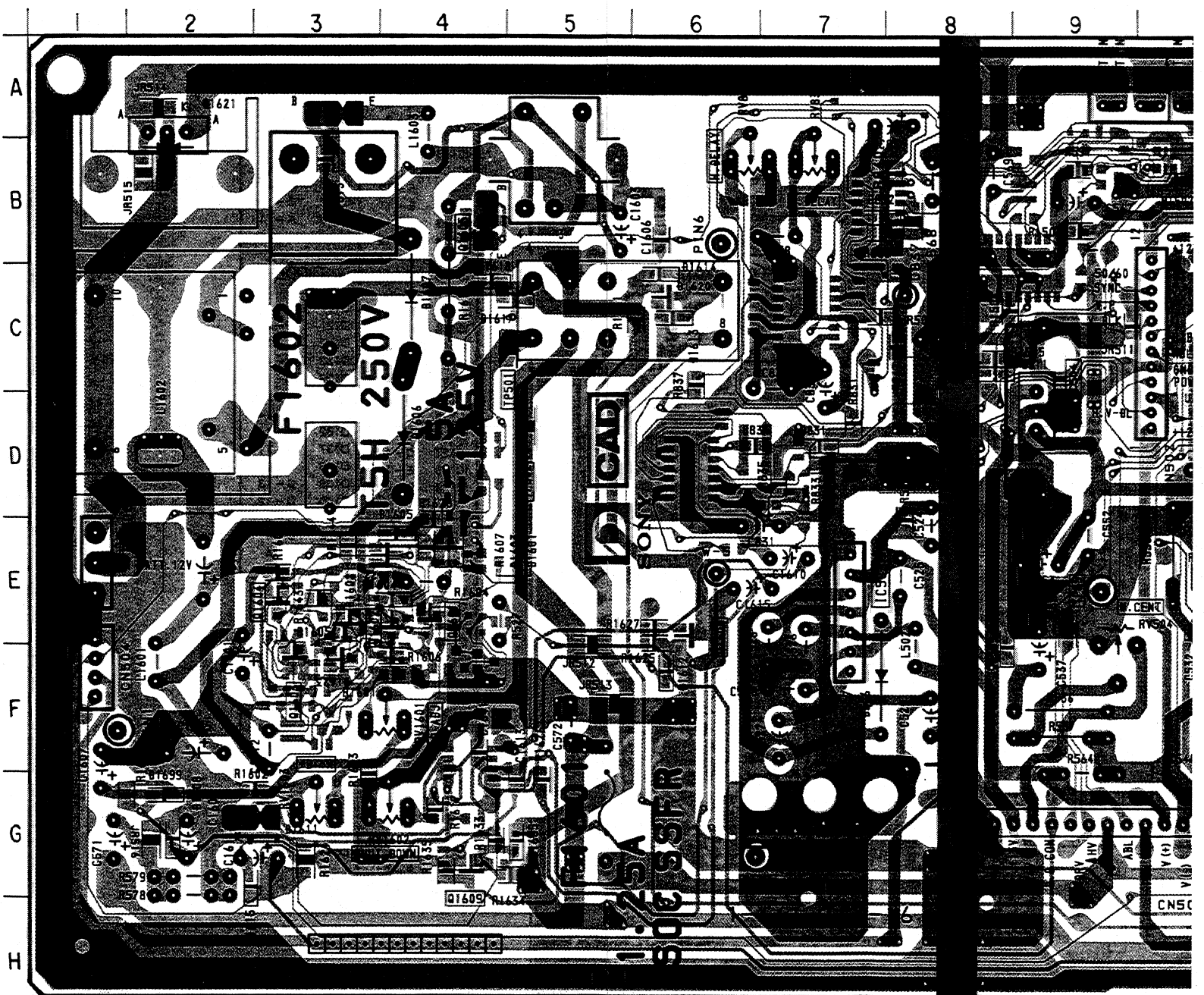

r Side -

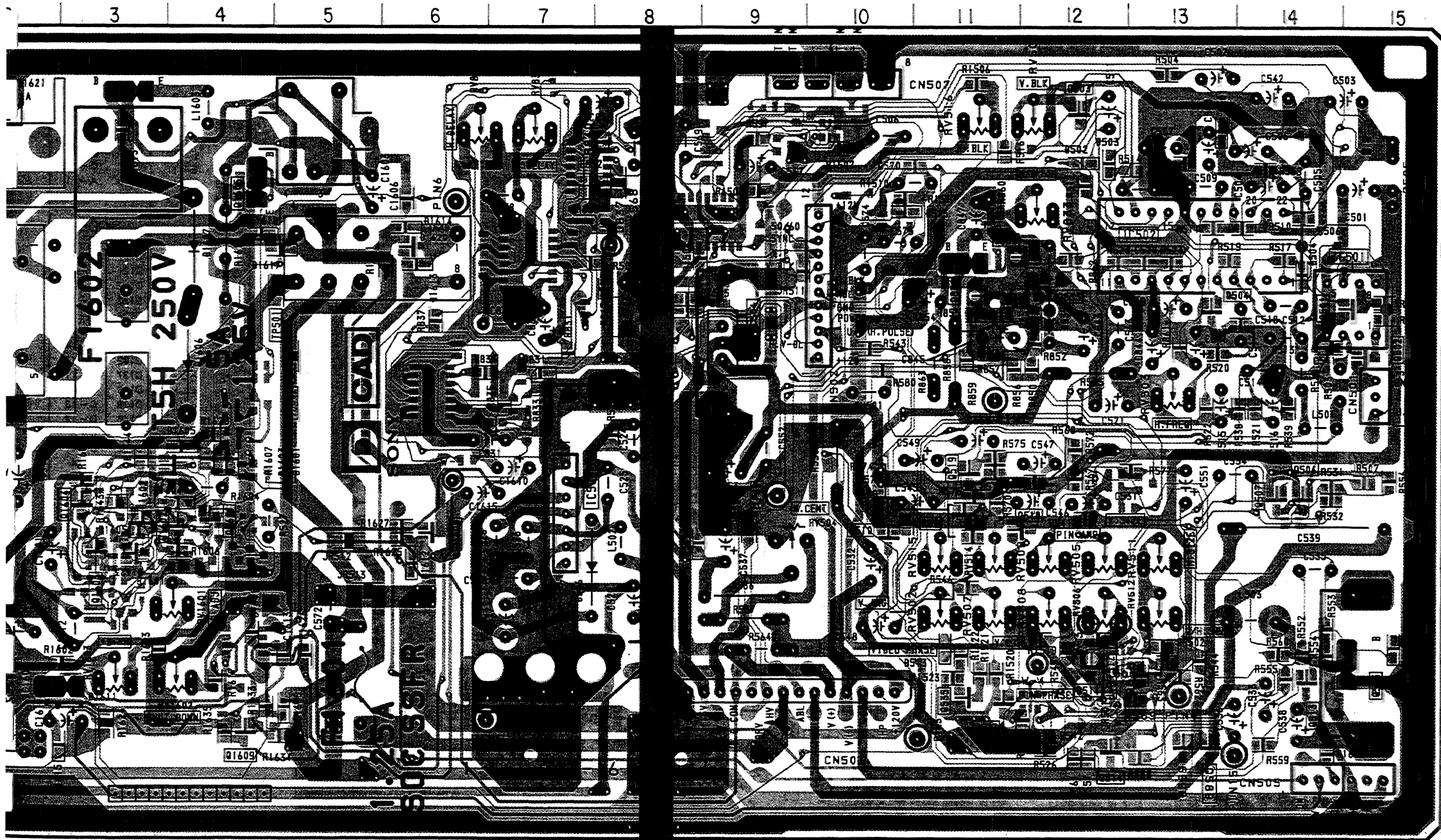

D Board (Conductor Side)

IC	D835 C-12
	D1601 E-4
IC501 C-15	D1603 E-4
IC502 C-13	D1606 D-4
IC503 E-7	D1607 C-4
IC504 D-9	D1608 G-2
	D1611 G-3
	D1612 F-6
	D1615 G-2
TRANSISTOR	D1617 C-4
Q501 C-15	D1618 C-4
Q502 D-15	D1620 C-6
Q503 A-12	D1622 E-4
Q504 C-13	D1623 F-3
Q510 E-10	D1635 G-5
Q513 G-14	D1699 G-2
Q515 G-15	
Q518 E-12	
Q519 E-11	
Q589 B-6	VARIABLE RESISTOR
Q589 G-13	RV501 B-12
Q833 C-12	RV502 F-11
Q834 C-11	RV503 D-13
Q835 C-11	RV504 E-9
Q836 C-11	RV505 F-12
Q1601 E-4	RV506 F-12
Q1602 E-4	RV507 F-11
Q1603 F-3	RV508 F-12
Q1604 E-3	RV509 F-12
Q1605 B-4	RV511 F-13
Q1606 A-3	RV512 F-13
Q1608 E-6	RV514 F-11
Q1609 G-4	RV515 F-11
	RV516 B-11
	RV831 B-7
DIODE	RV832 B-6
D501 B-13	RV833 B-12
D502 B-12	RV1601 F-4
D503 B-12	RV1602 G-4
D504 C-14	RV1603 G-3
D506 F-7	
D507 G-15	
D511 C-8	
D589 G-13	
D831 D-7	
D832 B-7	

- [Pattern] : Pattern from the side which enables seeing.
- [Pattern] : Pattern of the rear side.

B [SIGNAL PROCESS]

- B Board - - Component Side -

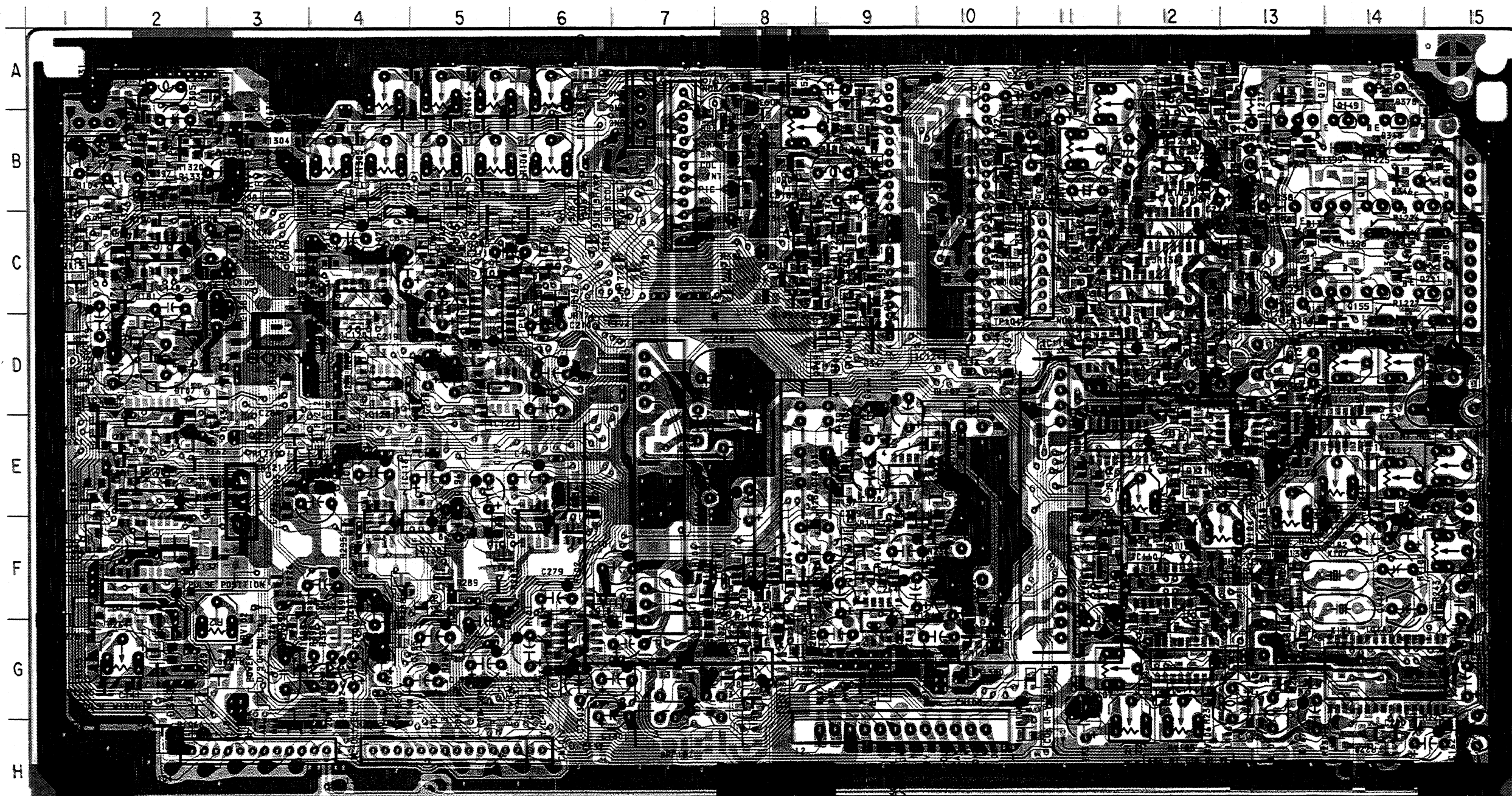

B Board (Component Side)

IC		DIODE	
IC102	G-9	Q189	G-4
IC103	G-8	Q191	B-2
IC104	E-9	Q193	B-1
IC105	G-6	Q196	B-2
IC106	F-2	Q197	B-2
IC107	E-2	Q198	A-3
IC108	E-2	Q200	F-8
IC109	C-2	Q204	B-9
IC110	F-12	Q205	A-9
IC111	E-11	Q206	A-8
IC113	G-14	Q208	B-3
IC114	G-12	Q212	C-11
IC115	E-14	Q299	A-11
IC116	D-11		
IC117	F-6		
IC118	F-5	D107	D-2
IC119	F-4	D121	E-4
IC120	C-4	D122	E-4
IC121	D-5	D123	C-4
IC122	D-5	D128	E-1
IC123	D-4	D130	B-13
IC125	C-12	D131	C-14
IC126	C-12	D132	D-14
IC127	C-12	D137	G-11
IC128	E-13	D138	B-13
IC129	B-4	D139	C-13
		D146	D-12
		D151	C-5
		D152	B-4
		D153	B-4
		D154	B-13
		D156	C-13
		D157	A-13
		D162	B-11
		D188	C-9
		D191	C-1
		D342	D-12
		D343	H-2
		D344	F-8
		D345	A-14
		D346	B-14
		D347	C-14
		D348	B-14
		D349	C-14
		D350	D-14
		D390	D-1
		D393	G-3
Q101	F-6		
Q104	G-10		
Q109	A-12		
Q115	C-1		
Q119	F-12		
Q121	E-12		
Q124	F-11		
Q129	G-3		
Q132	C-5		
Q136	F-6		
Q137	F-5		
Q138	F-5		
Q141	C-6		
Q150	G-8		
Q164	B-12		
Q166	D-12		
Q171	F-9		
Q176	F-9		

• [Pattern] : Pattern from the side which enables seeing.
 • [Pattern] : Pattern of the rear side.

- B Board - - Conductor Side -

B Board (Component Side)

IC	Q189	G-4	
	Q191	B-2	
	Q193	B-1	
IC102	G-9	Q196	B-2
IC103	G-8	Q197	B-2
IC104	E-9	Q198	A-3
IC105	G-6	Q200	F-8
IC106	F-2	Q204	B-9
IC107	E-2	Q205	A-9
IC108	E-2	Q206	A-8
IC109	C-2	Q208	B-3
IC110	F-12	Q212	C-11
IC111	E-11	Q299	A-11
IC113	G-14		
IC114	G-12		
IC115	E-14		
IC116	D-11		
IC117	F-6		
IC118	F-5		
IC119	F-4		
IC120	C-4		
IC121	D-5		
IC122	D-5		
IC123	D-4		
IC125	C-12		
IC126	C-12		
IC127	C-12		
IC128	E-13		
IC129	B-4		
	DIODE		
	D107	D-2	
	D121	E-4	
	D122	E-4	
	D123	C-4	
	D128	E-1	
	D130	B-13	
	D131	C-14	
	D132	D-14	
	D137	G-11	
	D138	B-13	
	D139	C-13	
	D146	D-12	
	D151	C-5	
	D152	B-4	
	D153	B-4	
	D154	B-13	
	D156	C-13	
	D157	A-13	
	D162	B-11	
	D188	C-9	
	D191	C-1	
	D342	D-12	
	D343	H-2	
	D344	F-8	
	D345	A-14	
	D346	B-14	
	D347	C-14	
	D348	B-14	
	D349	C-14	
	D350	D-14	
	D390	D-1	
	D393	G-3	
TRANSISTOR			
Q101	F-6		
Q104	G-10		
Q109	A-12		
Q115	C-1		
Q119	F-12		
Q121	E-12		
Q124	F-11		
Q129	G-3		
Q132	C-5		
Q136	F-6		
Q137	F-5		
Q138	F-5		
Q141	C-6		
Q150	G-8		
Q164	B-12		
Q166	D-12		
Q171	F-9		
Q176	F-9		

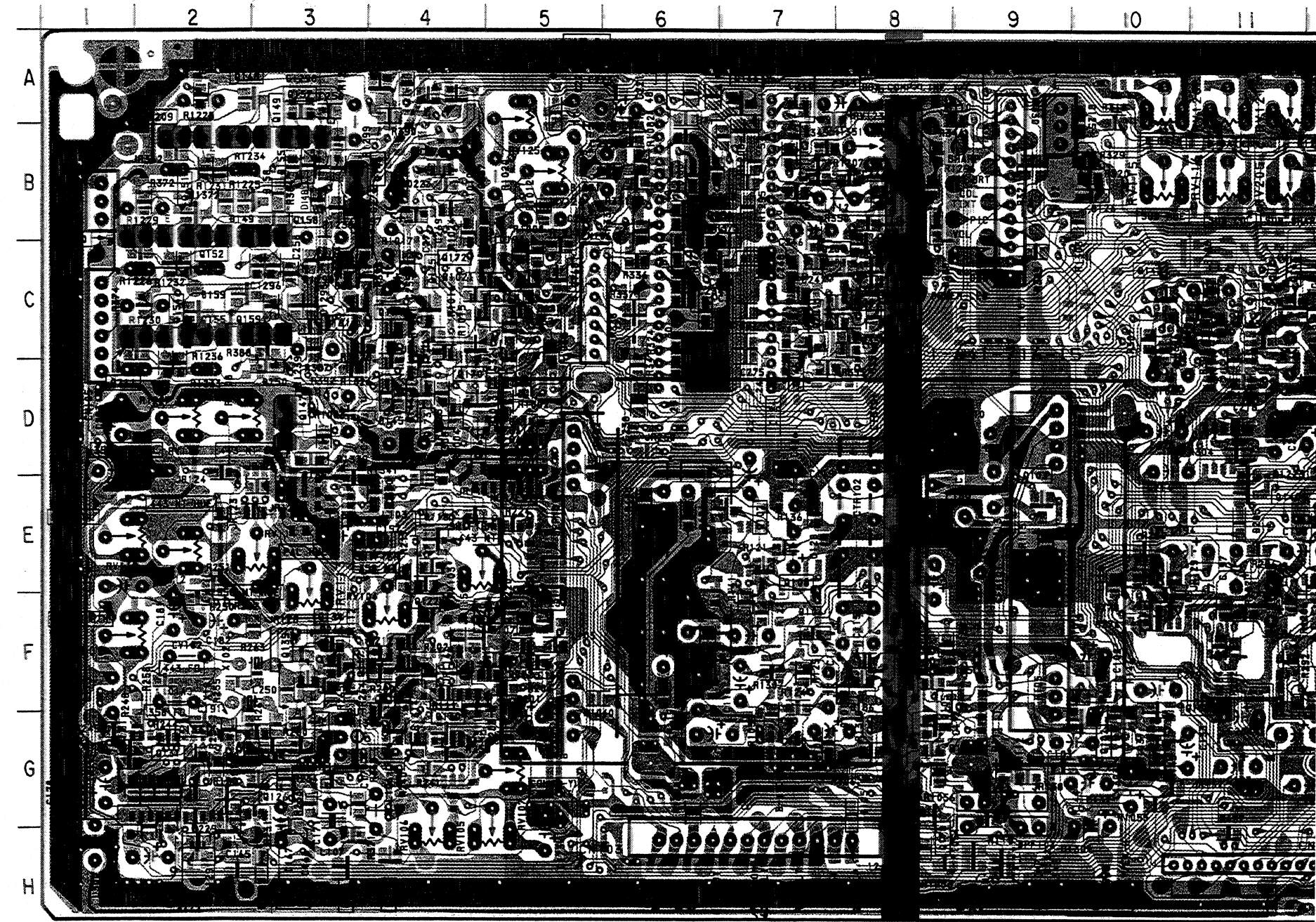
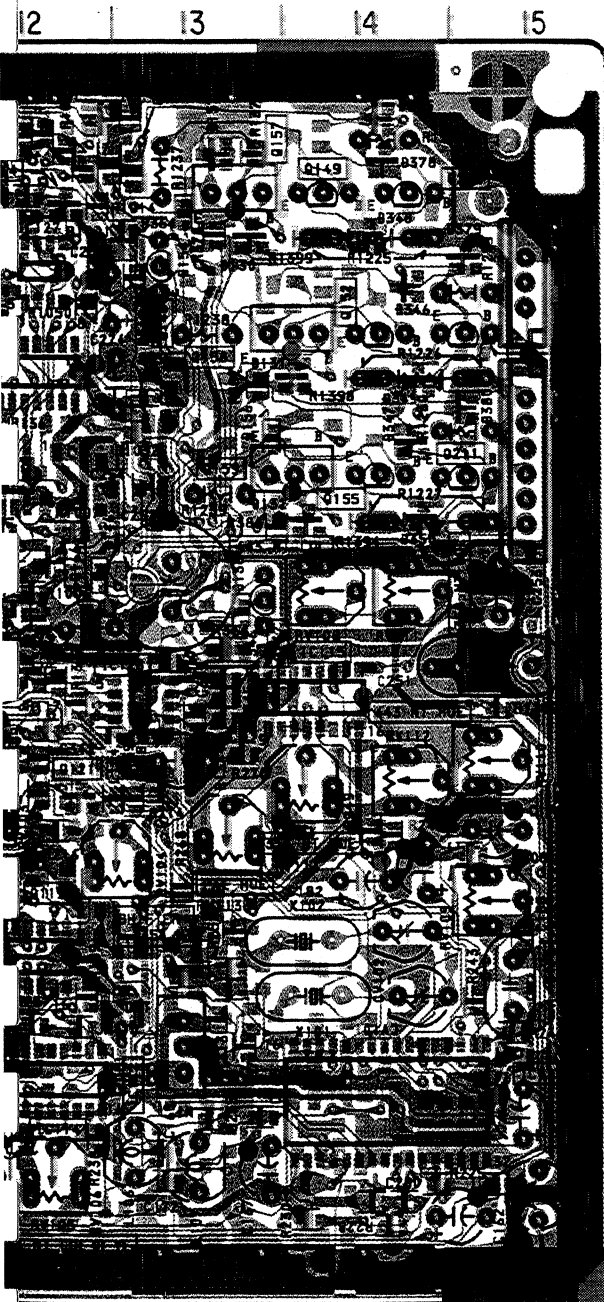

- [Pattern] : Pattern from the side which enables seeing.
- [Pattern] : Pattern of the rear side.

Side -

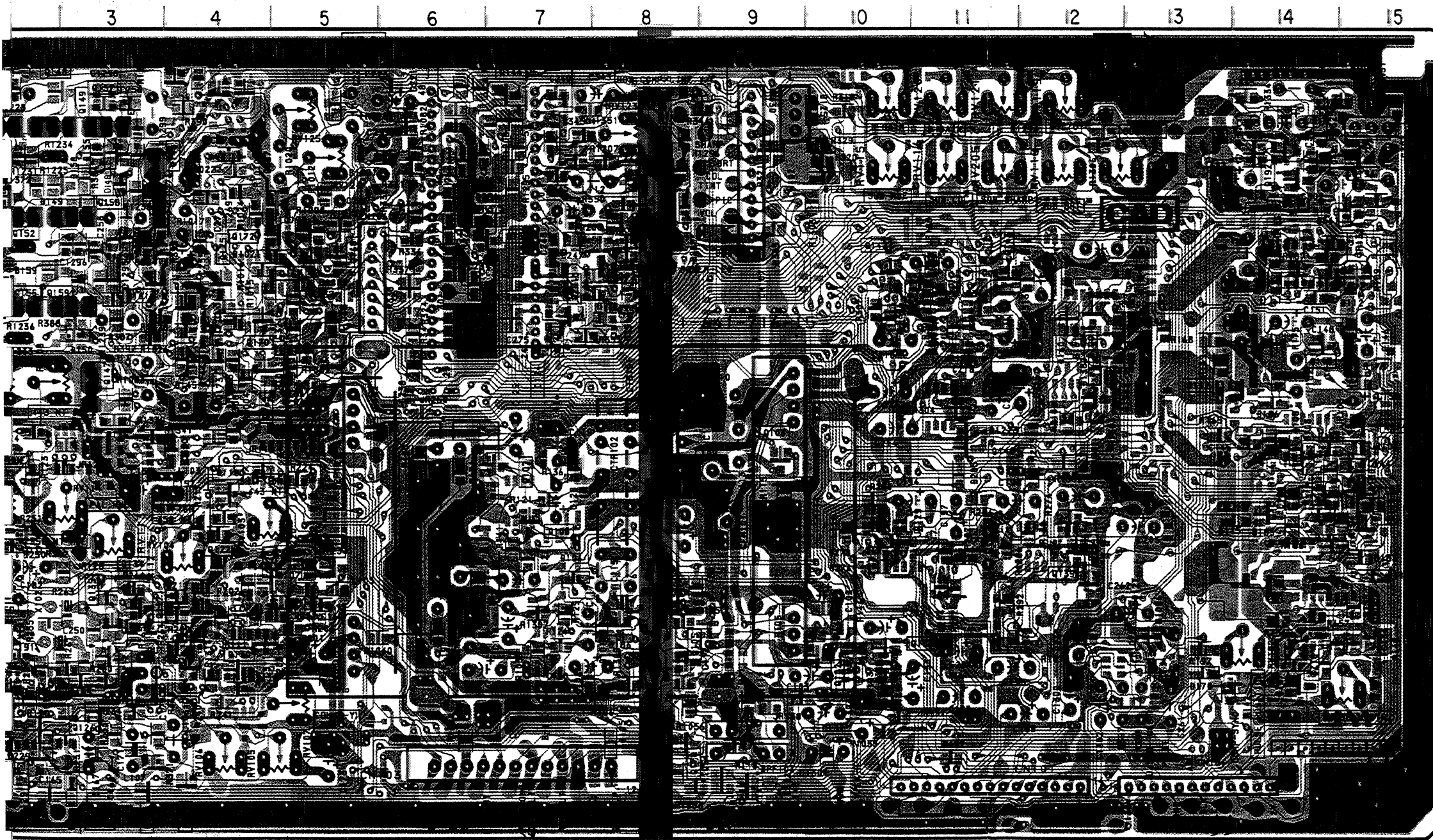

B Board (Conductor Side)

IC	Q174 C-4	VARIABLE RESISTOR
IC112 G-3	Q175 C-4	RV101 G-15
IC124 C-7	Q177 A-4	RV102 G-14
	Q179 A-4	RV103 E-4
	Q190 C-12	RV104 F-4
	Q192 B-14	RV105 H-5
	Q194 B-15	RV106 H-4
	Q195 B-14	RV107 G-5
	Q199 A-15	RV108 D-2
	Q201 C-7	RV109 F-1
	Q202 C-8	RV110 E-1
	Q203 C-8	RV111 D-2
	Q210 B-2	RV112 E-2
	Q211 C-2	RV113 F-3
		RV114 E-3
		RV115 A-10
		RV116 B-11
		RV118 B-12
		RV119 A-12
		RV120 A-11
		RV121 A-11
		RV122 A-10
		RV123 B-8
		RV124 B-5
		RV125 A-5
		RV205 B-11

TRANSISTOR		DIODE	
Q102 G-10	Q103 E-9	D104 F-7	D105 G-8
Q106 F-10	Q107 E-7	D106 D-14	D108 E-14
Q108 E-7	Q112 D-14	D109 E-14	D110 F-14
Q113 D-14	Q114 D-15	D111 F-15	D112 C-15
Q116 E-15	Q117 F-15	D113 C-14	D117 E-14
Q118 E-4	Q120 F-4	D120 H-3	D125 A-10
Q122 F-4	Q123 F-5	D126 B-10	D127 F-13
Q125 H-2	Q126 G-3	D129 H-2	D133 B-6
Q127 H-4	Q128 H-3	D134 C-6	D135 C-6
Q130 G-4	Q131 G-2	D136 D-3	D144 D-4
Q133 G-3	Q134 F-3	D145 D-4	D147 A-5
Q135 F-3	Q139 F-12	D148 B-3	D149 B-2
Q140 E-11	Q142 C-10	D150 D-3	D155 B-3
Q143 C-11	Q144 A-7	D158 B-3	D159 C-2
Q145 C-7	Q146 B-3	D160 D-12	D161 D-12
Q147 D-3	Q148 A-2	D170 G-13	D185 E-14
Q149 B-2	Q151 B-2	D186 F-8	D187 G-14
Q152 B-2	Q153 C-7	D285 E-11	D289 B-8
Q154 C-2	Q155 C-2	D341 B-14	D382 D-12
Q157 B-3	Q158 B-3		
Q160 A-4	Q161 C-3		
Q165 D-4	Q167 C-5		
Q168 C-5	Q170 C-4		
Q172 C-4	Q173 D-4		

- [Pattern] : Pattern from the side which enables seeing.
- [Pattern] : Pattern of the rear side.

PVM-9041QM/9044QM PVM-9041QM/9044QM

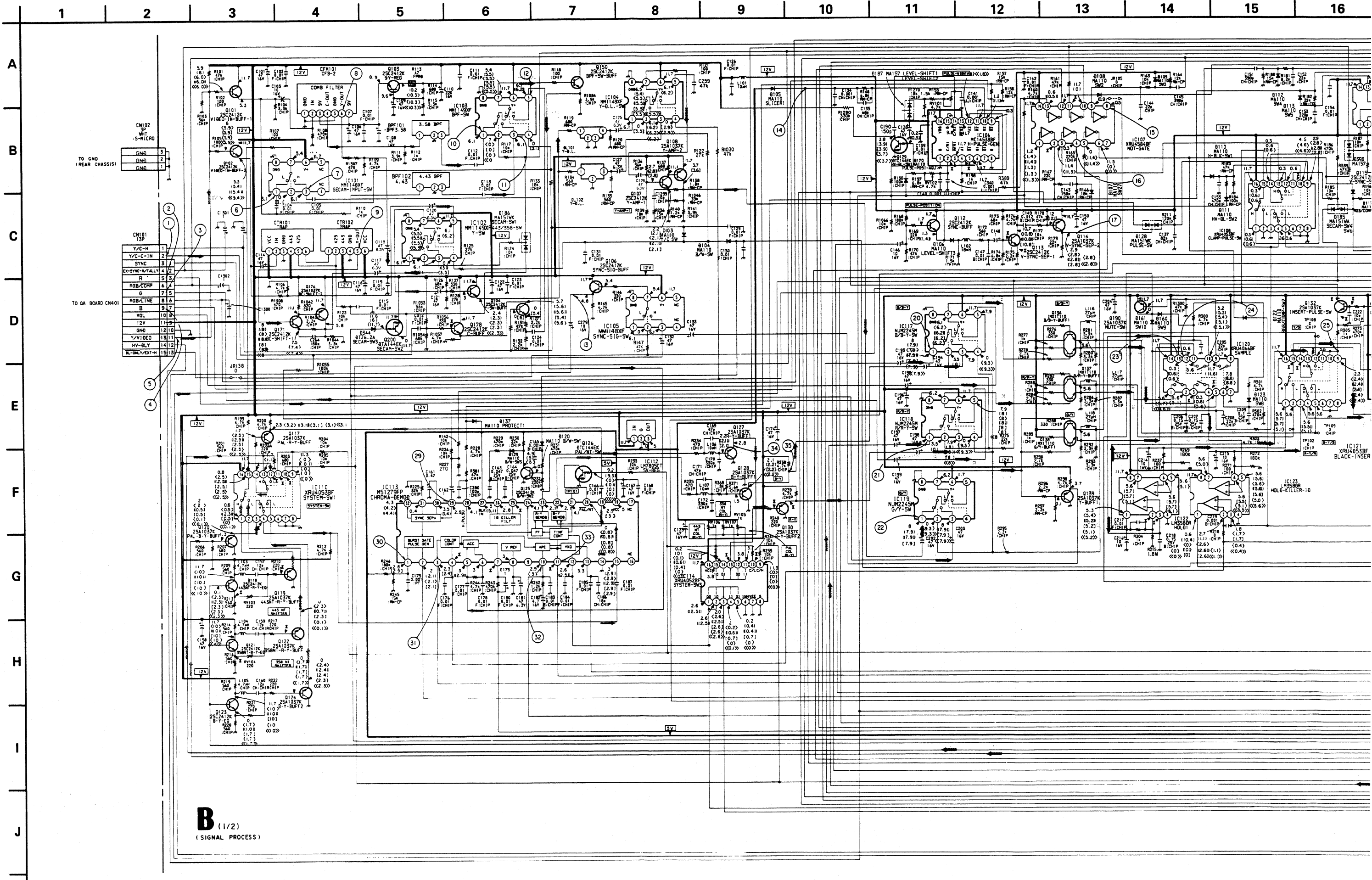

B (1/2)
(SIGNAL PROCESS)

A
B
C
D
E
F
G
H
I
J

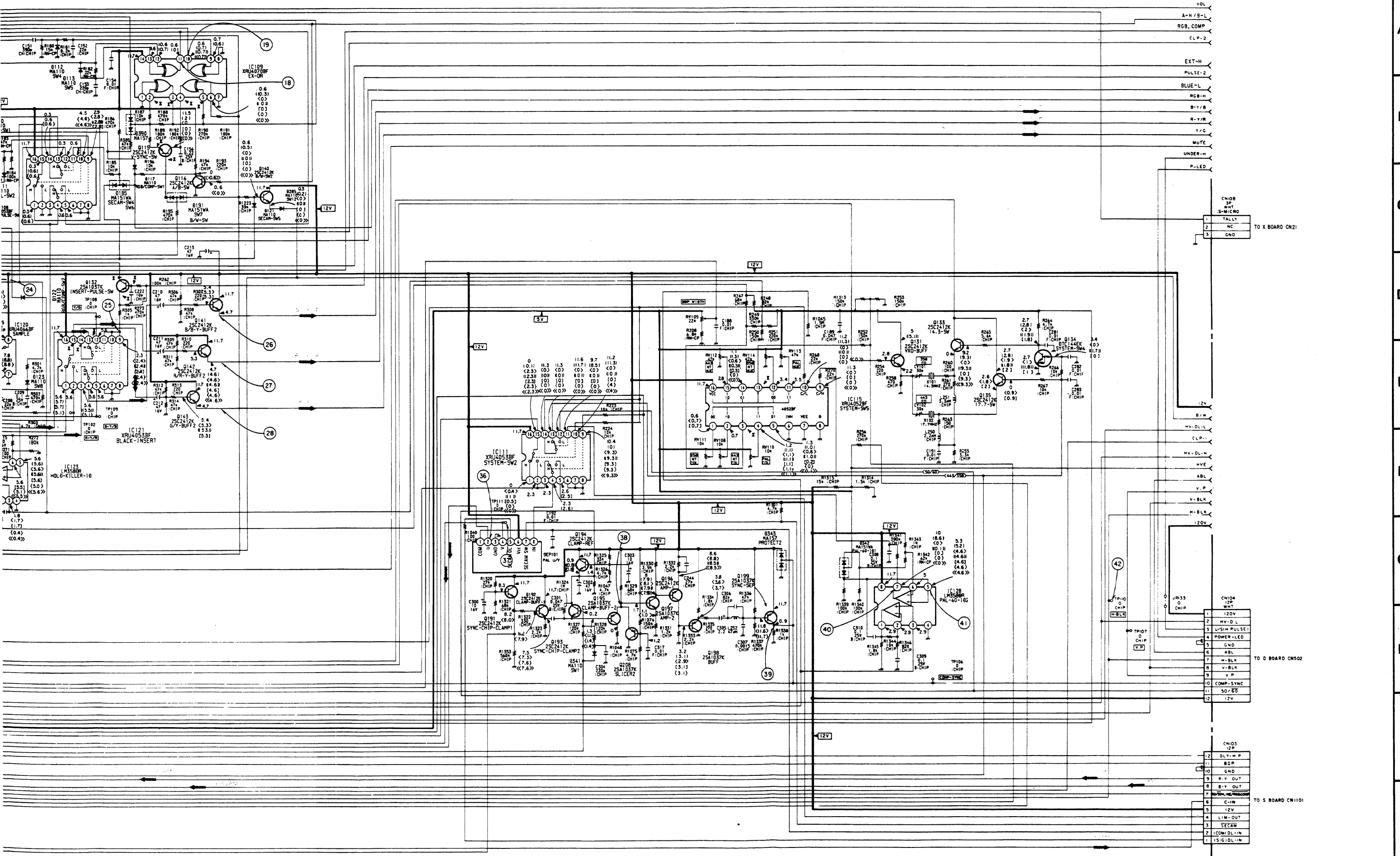

1 2 3 4 5 6 7 8 9 10 11 12 13 14 15

A
B
C
D
E
F
G
H
I
J

X
1
2
3
4
5
6
7
8
9
10
11
12
13
14
15
16
17
18
19
20
21
22
23
24
25
26
27
28
29
30
31
32
33
34
35
36
37
38
39
40
41
42
43
44
45
46
47
48
49
50
51
52
53
54
55
56
57
58
59
60

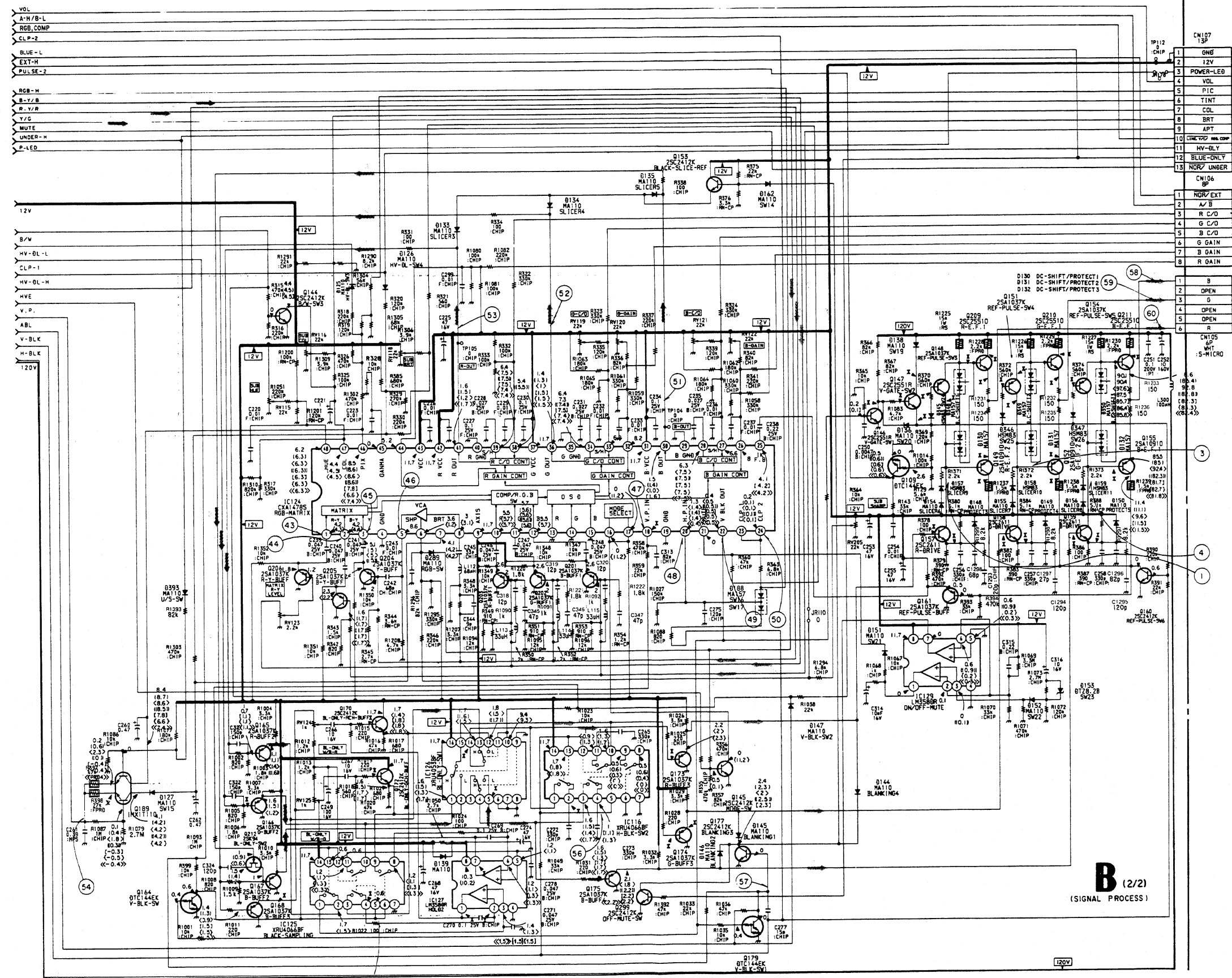

1	ONB
2	12V
3	POWER-LED
4	VOL
5	PIC
6	TINT
7	COL
8	BRT
9	APT
10	THE VPD
11	HV-BLY
12	BLUE-ONLY
13	NOR/ UNDER
CN107	
1	13P
CN106	
1	NOR/ EXT
2	A/ B
3	R C/O
4	G C/O
5	B C/O
6	G GAIN
7	B GAIN
8	R GAIN
TO H BOARD CN001	
TO H BOARD CN002	
TO C BOARD CN701	
1	B
2	OPEN
3	G
4	OPEN
5	OPEN
6	R
CN105	
1	WHT
2	S-MICRO

B (2/2)
(SIGNAL PROCESS)

— B Board —

		< TRANSISTOR >						
		PAL	SECAM	NTSC 3.58	NTSC 4.43	S (Y/C)	ANALOG RGB	COMPONENT
Q113	E	0.5	0.5	0.4	0.4	0.5	0.5	0.5
	B	1.0	1.0	0.9	0.9	0.9	0.9	1.0
Q115	E	11.2	9.3	0.0	10.8	0.0	0.0	0.0
	B	2.8	2.2	0.1	2.4	0.1	0.1	0.0
Q118	E	0.0	0.0	1.7	1.7	1.7	1.7	1.7
Q119	B	0.1	0.0	1.7	1.7	1.7	1.7	1.7
Q121	E	0.0	0.0	1.7	1.7	1.7	1.7	1.7
Q122	B	0.0	0.0	1.7	1.7	1.7	1.7	1.7
Q130	E	4.3	4.3	4.4	4.4	4.5	4.4	4.4
	B	3.7	3.7	3.8	3.8	3.9	3.8	3.8
Q132	E	2.3	2.3	2.4	2.3	2.4	2.4	2.4
	C	1.8	1.7	1.7	1.7	1.7	1.8	1.8
	B	2.7	2.8	2.8	2.7	2.8	2.7	2.8
Q146	C	118.7	114.4	110.4	113.2	113.7	114.3	114.1
Q147	E	117.9	115.8	111.8	114.5	115.0	115.5	115.4
	C	128.0	123.5	120.3	123.4	123.8	124.8	124.4
	B	119.8	119.5	110.5	118.4	118.2	114.2	114.2
Q148	C	88.1	84.9	81.2	83.4	82.8	82.5	82.2
	B	94.0	93.3	88.3	92.4	92.1	94.2	90.6
Q149	E	1.8	1.8	1.4	1.7	1.7	1.7	1.7
	C	88.1	84.9	81.2	83.4	82.7	82.5	82.5
Q151	E	90.7	91.4	98.0	87.9	87.0	88.5	88.4
	C	89.2	89.8	98.5	88.4	85.3	84.9	84.7
	B	92.1	92.7	100.2	89.5	92.4	90.5	88.9
Q152	E	88.1	88.0	92.8	82.8	82.9	82.8	82.7
	C	10.8	10.5	9.7	10.9	10.9	10.9	11.0
Q154	B	92.5	92.9	99.8	90.1	88.7	90.4	89.2
Q155	B	88.3	88.5	95.7	85.7	83.9	84.8	83.9
Q157	E	82.4	81.1	87.5	79.9	79.9	80.8	79.4
	B	88.0	84.8	91.2	84.4	82.7	82.5	82.1
Q158	E	1.8	1.5	1.3	1.8	1.8	1.7	1.7
	B	2.1	2.0	1.8	2.1	2.2	2.2	2.2
Q159	E	1.8	1.8	1.3	1.8	1.7	1.7	1.7
	B	2.2	2.1	1.5	2.1	2.2	2.2	2.2
Q183	E	0.2	0.8	2.7	0.5	-0.5	-0.7	-0.8
Q188	B	0.9	0.9	0.6	1.0	1.0	1.0	1.0
Q188	C	2.1	2.0	1.8	2.1	2.2	2.1	2.2
Q170	B	2.3	2.3	2.1	2.4	2.4	2.4	2.4
Q172	B	2.2	2.1	1.9	2.2	2.3	2.2	2.3
Q173	B	1.7	1.8	1.4	1.7	1.7	1.7	1.7
Q174	E	2.1	2.0	1.8	2.1	2.2	2.2	2.2
	B	1.8	1.5	1.3	1.8	1.8	1.7	1.7
Q178	B	6.2	6.3	6.2	6.3	6.1	6.2	6.2
Q209	E	83.4	81.5	87.9	80.3	80.4	80.4	79.8
	C	115.8	113.2	110.7	113.2	113.8	114.5	114.2
	B	87.8	86.4	92.8	85.0	84.3	84.2	83.8
Q210	E	88.5	86.3	93.1	83.0	83.3	83.0	82.8
	C	118.5	114.2	111.5	113.9	114.5	115.1	114.8
Q211	C	115.9	113.8	111.7	113.3	113.8	114.5	114.3

< IC >

		PAL	SECAM	NTSC 3.58	NTSC 4.43	S (Y/C)	ANALOG RGB	COMPONENT
IC102	②	6.8	6.8	0.0	6.8	0.0	0.0	0.0
IC108	②	0.2	0.1	0.1	0.1	0.1	0.1	0.2
	④	1.8	1.7	1.7	1.7	1.7	1.8	1.8
IC107	②	10.7	10.7	10.8	10.8	10.8	10.8	10.8
	①	1.2	10.7	0.0	0.0	0.0	0.0	0.0
IC108	①	9.7	0.4	9.7	9.8	9.8	1.1	9.8
IC109	②	11.3	11.3	0.0	10.8	0.0	0.0	0.0
	③	11.3	11.4	0.0	11.3	0.0	0.0	0.0
	④	11.7	0.0	0.0	11.7	0.0	0.0	0.0
	⑤	11.0	11.1	0.0	11.0	0.0	0.0	0.0
IC110	④	2.1	2.2	2.5	2.5	2.5	2.5	2.5
	⑤	11.3	11.3	0.0	11.3	0.0	0.0	0.0
	⑥	11.3	11.3	0.0	0.0	0.0	0.0	0.0
	⑦	0.8	0.8	2.5	2.5	2.5	2.5	2.5
	⑧	1.7	1.7	2.5	2.8	2.5	2.5	2.5
IC113	④	2.7	1.1	2.8	2.8	2.8	1.1	1.1
	⑦	4.2	4.3	4.2	4.3	4.3	4.8	4.8
	⑧	3.0	2.9	2.8	3.0	2.8	2.9	2.9
	⑨	2.2	2.5	2.9	2.2	1.9	2.8	2.8
IC114	⑨	11.4	11.3	0.0	0.0	0.0	0.0	0.0
	⑩	3.7	3.7	3.8	3.8	3.8	3.9	3.9
IC115	③	1.2	1.1	0.8	0.7	0.7	0.8	0.8
	④	3.5	3.5	3.4	2.8	3.4	3.4	3.4
IC116	②	0.0	0.0	1.0	1.1	1.1	1.3	1.1
IC120	③	5.5	5.8	5.8	5.8	5.8	5.8	5.8
	④	5.5	5.8	5.8	5.8	5.8	5.0	5.8
IC121	⑤	5.3	5.3	5.4	5.2	5.2	5.1	5.1
	⑥	5.8	5.7	5.8	5.8	5.7	5.7	5.7
	⑦	5.8	5.7	5.8	5.8	5.7	5.7	5.8
IC122	②	5.3	5.3	5.4	5.2	5.2	5.1	5.1
	③	5.3	5.3	5.4	5.2	5.2	5.1	5.1
IC124	①	0.1	0.1	0.2	0.2	0.2	0.2	0.2
IC125	④	1.4	1.4	1.3	1.4	1.5	1.5	1.5
IC126	②	1.8	1.5	1.3	1.8	1.8	1.7	1.8
	⑤	1.8	1.5	1.3	1.8	1.8	1.8	1.7
	⑥	1.7	1.8	1.4	1.7	1.7	1.8	1.7
IC127	①	3.0	2.9	2.8	3.0	3.1	3.0	3.0
	②	1.4	1.4	1.3	1.5	1.5	1.5	1.5
	⑦	2.1	2.7	2.4	2.8	2.8	2.8	2.8

• B BOARD WAVEFORMS

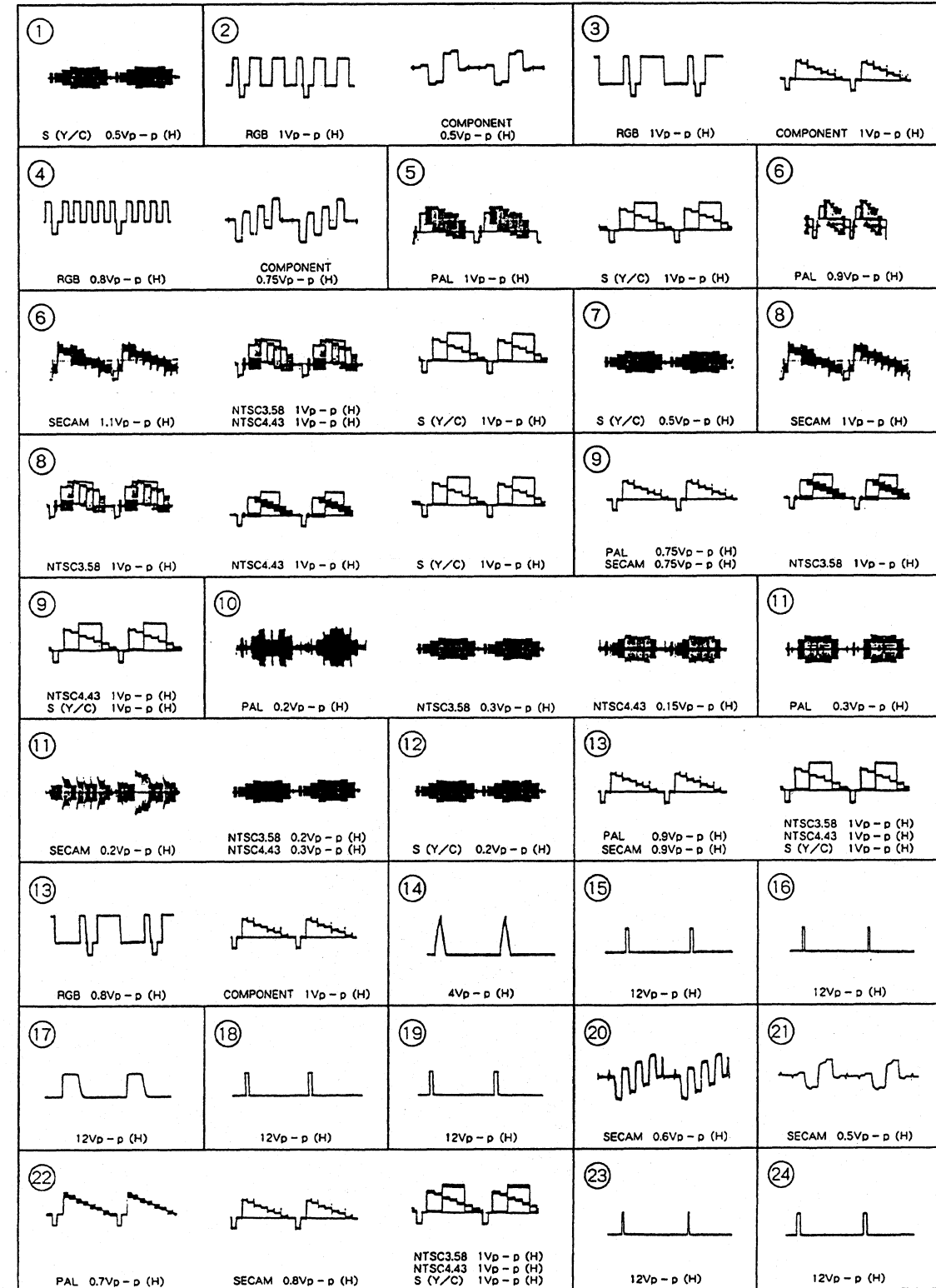

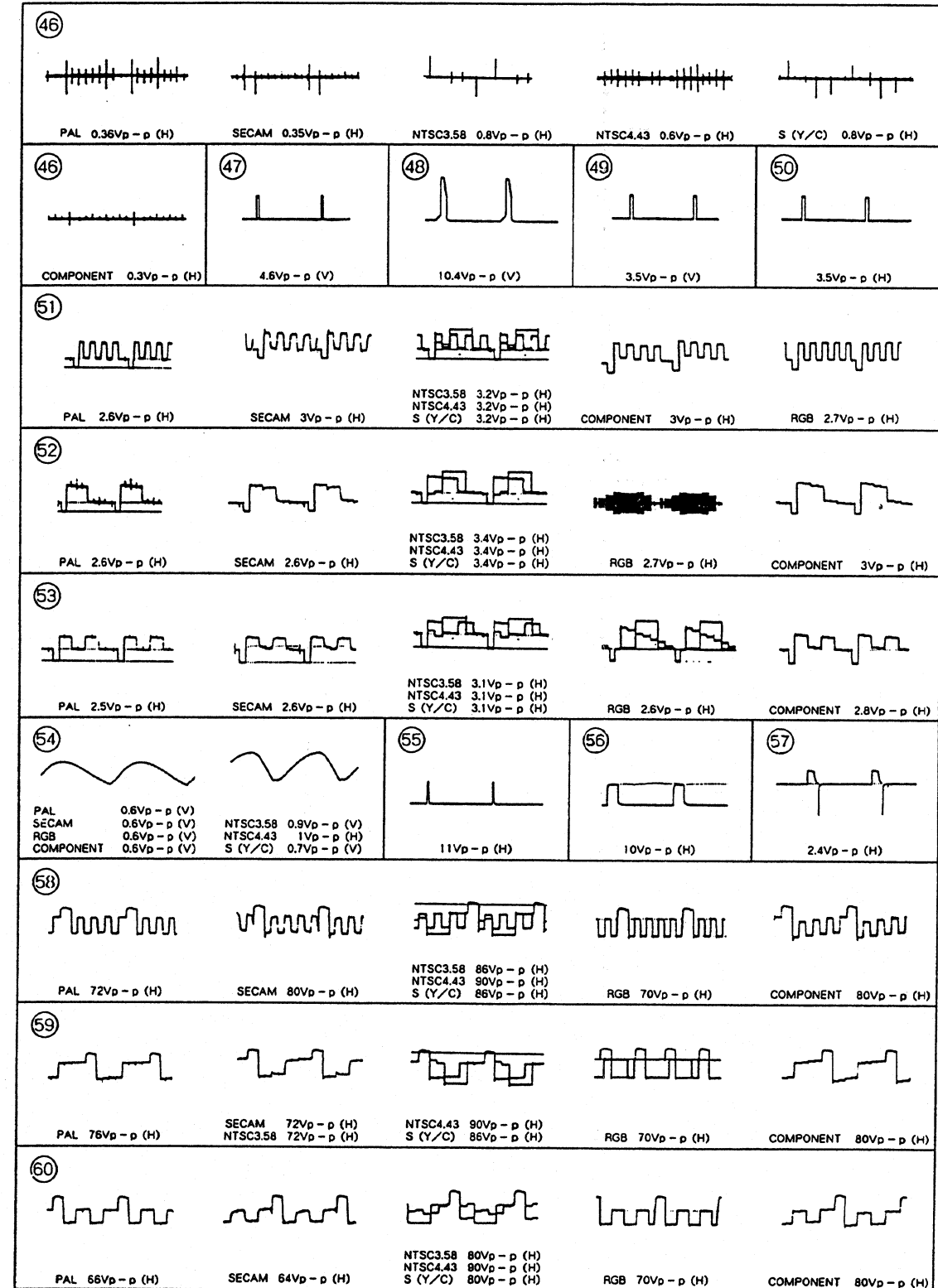
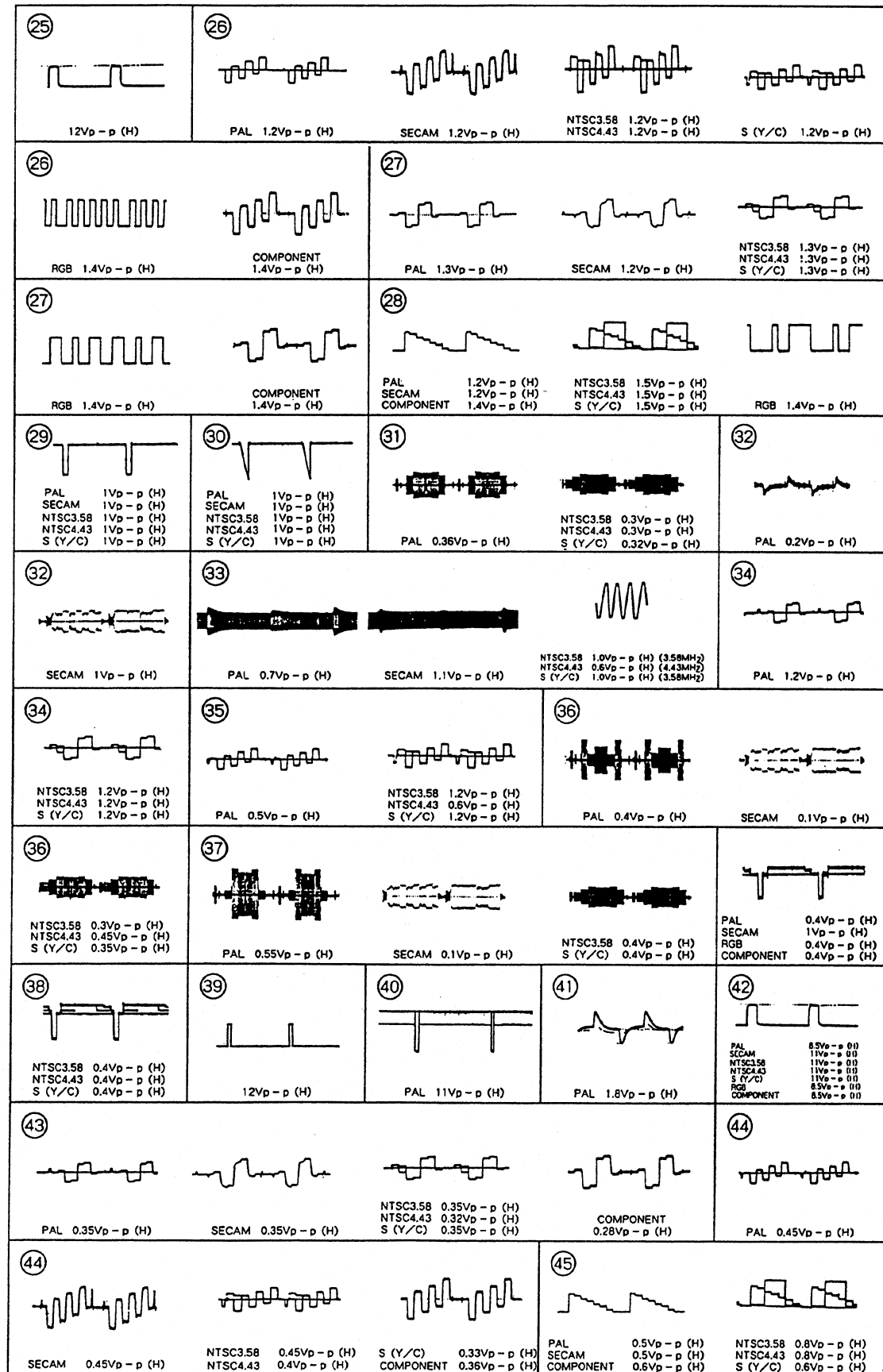

NOTE:

The component shading and call for safety. Replace only specified.

REF. NO. PART

*A-11

BPF101 1-23
BPF102 1-23

C101 1-12
C102 1-16
C103 1-12
C104 1-16
C105 1-16

C106 1-12
C107 1-16
C108 1-12
C109 1-12
C110 1-12

C111 1-16
C112 1-16
C113 1-16
C114 1-12
C115 1-16

C116 1-12
C117 1-12
C118 1-12
C119 1-16
C120 1-12

C121 1-12
C122 1-12
C123 1-16
C124 1-16
C125 1-12

C126 1-16
C127 1-12
C128 1-12
C129 1-16
C130 1-16

C131 1-16
C132 1-12
C133 1-12
C134 1-16
C135 1-16

C137 1-16
C138 1-12
C139 1-16
C140 1-16
C141 1-16

C142 1-16

SECTION 2
ELECTRICAL PARTS LIST

B

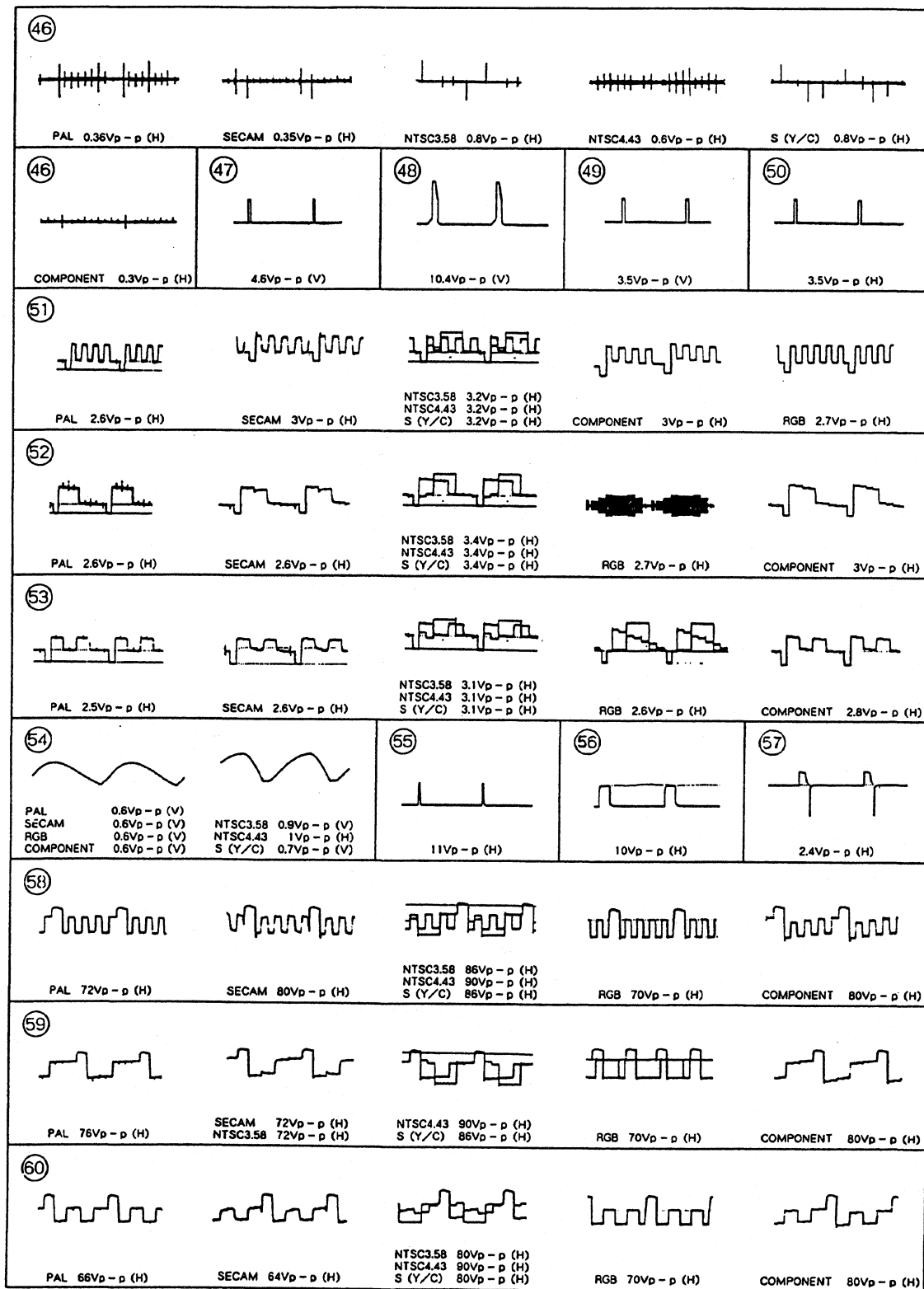

NOTE:

The components identified by shading and mark Δ are critical for safety. Replace only with part number specified.

Items marked " * " are not stocked since they are seldom required for routine service. Some delay should be anticipated when ordering these items.

When indicating parts by reference number, please include the board name.

All variable and adjustable resistors have characteristic curve B, unless otherwise noted.

RESISTORS

All resistors are in ohms
F : nonflammable

CAPACITORS

MF : μ F, PF : μ F MMH : mH, UH : μ H

COILS

The components identified by \square in this manual have been carefully factory-selected for each set in order to satisfy regulations regarding X-ray radiation. Should replacement be required, replace only with the value originally used.

REF.NO.	PART NO.	DESCRIPTION	REMARK	REF.NO.	PART NO.	DESCRIPTION	REMARK
*A-1135-716-A B BOARD, COMPLETE *****							
<FILTER>							
BPF101	1-236-363-11	FILTER, BAND PASS		C143	1-163-121-00	CERAMIC CHIP 150PF	5% 50V
BPF102	1-236-364-11	FILTER, BAND PASS		C144	1-163-101-00	CERAMIC CHIP 22PF	5% 50V
<CAPACITOR>							
C101	1-124-589-11	ELECT 47MF	20% 16V	C145	1-163-131-00	CERAMIC CHIP 390PF	5% 50V
C102	1-163-031-11	CERAMIC CHIP 0.01MF	50V	C146	1-126-157-11	ELECT 10MF	20% 16V
C103	1-126-157-11	ELECT 10MF	20% 16V	C147	1-164-232-11	CERAMIC CHIP 0.01MF	10% 50V
C104	1-163-031-11	CERAMIC CHIP 0.01MF	50V	C148	1-126-160-11	ELECT 1MF	20% 50V
C105	1-163-031-11	CERAMIC CHIP 0.01MF	50V	C149	1-163-022-00	CERAMIC CHIP 0.012MF	10% 50V
C106	1-124-477-11	ELECT 47MF	20% 16V	C150	1-124-589-11	ELECT 47MF	20% 16V
C107	1-163-031-11	CERAMIC CHIP 0.01MF	50V	C151	1-163-131-00	CERAMIC CHIP 390PF	5% 50V
C108	1-124-477-11	ELECT 47MF	20% 16V	C152	1-163-101-00	CERAMIC CHIP 22PF	5% 50V
C109	1-124-477-11	ELECT 47MF	20% 16V	C153	1-163-125-00	CERAMIC CHIP 220PF	5% 50V
C110	1-124-120-11	ELECT 220MF	20% 16V	C154	1-163-031-11	CERAMIC CHIP 0.01MF	50V
C111	1-163-031-11	CERAMIC CHIP 0.01MF	50V	C155	1-163-133-00	CERAMIC CHIP 470PF	5% 50V
C112	1-163-031-11	CERAMIC CHIP 0.01MF	50V	C156	1-164-299-11	CERAMIC CHIP 0.22MF	10% 25V
C113	1-163-031-11	CERAMIC CHIP 0.01MF	50V	C157	1-163-229-11	CERAMIC CHIP 12PF	5% 50V
C114	1-124-477-11	ELECT 47MF	20% 16V	C158	1-124-477-11	ELECT 47MF	20% 16V
C115	1-163-031-11	CERAMIC CHIP 0.01MF	50V	C159	1-163-229-11	CERAMIC CHIP 12PF	5% 50V
C116	1-124-589-11	ELECT 47MF	20% 16V	C160	1-163-229-11	CERAMIC CHIP 12PF	5% 50V
C117	1-126-154-11	ELECT 47MF	20% 6.3V	C161	1-124-902-00	ELECT 0.47MF	20% 50V
C118	1-126-154-11	ELECT 47MF	20% 6.3V	C162	1-124-903-11	ELECT 1MF	20% 50V
C119	1-163-031-11	CERAMIC CHIP 0.01MF	50V	C163	1-163-809-11	CERAMIC CHIP 0.047MF	10% 25V
C120	1-126-154-11	ELECT 47MF	20% 6.3V	C164	1-163-809-11	CERAMIC CHIP 0.047MF	10% 25V
C121	1-126-154-11	ELECT 47MF	20% 6.3V	C165	1-163-009-11	CERAMIC CHIP 0.001MF	10% 50V
C122	1-124-477-11	ELECT 47MF	20% 16V	C166	1-163-031-11	CERAMIC CHIP 0.01MF	50V
C123	1-163-031-11	CERAMIC CHIP 0.01MF	50V	C167	1-124-477-11	ELECT 47MF	20% 16V
C124	1-163-031-11	CERAMIC CHIP 0.01MF	50V	C168	1-163-031-11	CERAMIC CHIP 0.01MF	50V
C125	1-126-154-11	ELECT 47MF	20% 6.3V	C169	1-163-243-11	CERAMIC CHIP 47PF	5% 50V
C126	1-163-031-11	CERAMIC CHIP 0.01MF	50V	C170	1-163-129-00	CERAMIC CHIP 330PF	5% 50V
C127	1-126-154-11	ELECT 47MF	20% 6.3V	C171	1-163-243-11	CERAMIC CHIP 47PF	5% 50V
C128	1-126-154-11	ELECT 47MF	20% 6.3V	C172	1-163-129-00	CERAMIC CHIP 330PF	5% 50V
C129	1-163-031-11	CERAMIC CHIP 0.01MF	50V	C173	1-124-589-11	ELECT 47MF	20% 16V
C130	1-163-031-11	CERAMIC CHIP 0.01MF	50V	C174	1-124-477-11	ELECT 47MF	20% 16V
C131	1-163-031-11	CERAMIC CHIP 0.01MF	50V	C175	1-108-792-11	MYLAR 0.001MF	5% 50V
C132	1-124-589-11	ELECT 47MF	20% 16V	C176	1-163-031-11	CERAMIC CHIP 0.01MF	50V
C133	1-124-589-11	ELECT 47MF	20% 16V	C177	1-163-031-11	CERAMIC CHIP 0.01MF	50V
C134	1-163-275-11	CERAMIC CHIP 0.001MF	5% 50V	C178	1-163-031-11	CERAMIC CHIP 0.01MF	50V
C135	1-163-113-00	CERAMIC CHIP 68PF	5% 50V	C179	1-126-160-11	ELECT 1MF	20% 50V
C137	1-163-115-00	CERAMIC CHIP 82PF	5% 50V	C180	1-163-031-11	CERAMIC CHIP 0.01MF	50V
C138	1-124-589-11	ELECT 47MF	20% 16V	C181	1-126-154-11	ELECT 47MF	20% 6.3V
C139	1-163-031-11	CERAMIC CHIP 0.01MF	50V	C182	1-126-163-11	ELECT 4.7MF	20% 16V
C140	1-163-205-00	CERAMIC CHIP 0.001MF	5% 50V	C183	1-164-232-11	CERAMIC CHIP 0.01MF	10% 50V
C141	1-163-141-00	CERAMIC CHIP 0.001MF	5% 50V	C184	1-163-031-11	CERAMIC CHIP 0.01MF	50V
C142	1-163-031-11	CERAMIC CHIP 0.01MF	50V	C185	1-163-031-11	CERAMIC CHIP 0.01MF	50V
				C186	1-163-099-00	CERAMIC CHIP 18PF	5% 50V
				C187	1-163-031-11	CERAMIC CHIP 0.01MF	50V
				C188	1-163-031-11	CERAMIC CHIP 0.01MF	50V
				C189	1-163-035-00	CERAMIC CHIP 0.047MF	50V
				C190	1-163-121-00	CERAMIC CHIP 150PF	5% 50V
				C191	1-163-031-11	CERAMIC CHIP 0.01MF	50V
				C192	1-163-031-11	CERAMIC CHIP 0.01MF	50V
				C193	1-124-589-11	ELECT 47MF	20% 16V

REF. NO.	PART NO.	DESCRIPTION	REMARK	REF. NO.	PART NO.	DESCRIPTION	REMARK
Q208	8-729-216-22	TRANSISTOR 2SA1162-G		R167	1-216-635-11	METAL CHIP 220 0.50%	1/10W
Q209	8-729-255-12	TRANSISTOR 2SC2551-0		R168	1-216-103-00	METAL GLAZE 180K 5%	1/10W
Q210	8-729-255-12	TRANSISTOR 2SC2551-0		R169	1-216-033-00	METAL GLAZE 220 5%	1/10W
Q211	8-729-255-12	TRANSISTOR 2SC2551-0		R170	1-216-089-00	METAL GLAZE 47K 5%	1/10W
Q212	8-729-109-44	TRANSISTOR 2SK94		R171	1-216-053-00	METAL GLAZE 1.5K 5%	1/10W
Q299	8-729-422-27	TRANSISTOR 2SD601A-Q		R172	1-216-043-00	METAL GLAZE 560 5%	1/10W
		<RESISTOR>		R173	1-216-093-00	METAL GLAZE 68K 5%	1/10W
R101	1-216-089-00	METAL GLAZE 47K 5%		R174	1-216-069-00	METAL GLAZE 6.8K 5%	1/10W
R102	1-216-025-00	METAL GLAZE 100 5%		R175	1-216-057-00	METAL GLAZE 2.2K 5%	1/10W
R103	1-216-091-00	METAL GLAZE 56K 5%		R176	1-216-065-00	METAL GLAZE 4.7K 5%	1/10W
R104	1-216-061-00	METAL GLAZE 3.3K 5%		R177	1-216-073-00	METAL GLAZE 10K 5%	1/10W
R105	1-216-025-00	METAL GLAZE 100 5%		R178	1-216-089-00	METAL GLAZE 47K 5%	1/10W
R106	1-216-065-00	METAL GLAZE 4.7K 5%		R179	1-216-081-00	METAL GLAZE 22K 5%	1/10W
R107	1-216-025-00	METAL GLAZE 100 5%		R180	1-216-679-11	METAL CHIP 15K 0.50%	1/10W
R108	1-216-113-00	METAL GLAZE 470K 5%		R181	1-216-071-00	METAL GLAZE 8.2K 5%	1/10W
R109	1-216-065-00	METAL GLAZE 4.7K 5%		R182	1-216-683-11	METAL CHIP 22K 0.50%	1/10W
R110	1-216-049-00	METAL GLAZE 1K 5%		R183	1-216-691-11	METAL CHIP 47K 0.50%	1/10W
R111	1-216-063-00	METAL GLAZE 3.9K 5%		R184	1-216-699-11	METAL CHIP 100K 0.50%	1/10W
R112	1-216-049-00	METAL GLAZE 1K 5%		R185	1-216-073-00	METAL GLAZE 10K 5%	1/10W
R113	1-249-401-11	CARBON 47 5%	1/4W F	R186	1-216-113-00	METAL GLAZE 470K 5%	1/10W
R114	1-216-045-00	METAL GLAZE 680 5%		R187	1-216-073-00	METAL GLAZE 10K 5%	1/10W
R115	1-216-061-00	METAL GLAZE 3.3K 5%		R188	1-216-113-00	METAL GLAZE 470K 5%	1/10W
R117	1-216-073-00	METAL GLAZE 10K 5%		R189	1-216-103-00	METAL GLAZE 180K 5%	1/10W
R118	1-216-025-00	METAL GLAZE 100 5%		R190	1-216-107-00	METAL GLAZE 270K 5%	1/10W
R119	1-216-647-11	METAL CHIP 680 0.50%		R191	1-216-097-00	METAL GLAZE 100K 5%	1/10W
R120	1-216-647-11	METAL CHIP 680 0.50%		R192	1-216-103-00	METAL GLAZE 180K 5%	1/10W
R121	1-216-025-00	METAL GLAZE 100 5%		R193	1-216-105-00	METAL GLAZE 220K 5%	1/10W
R122	1-216-083-00	METAL GLAZE 27K 5%		R194	1-216-089-00	METAL GLAZE 47K 5%	1/10W
R123	1-216-073-00	METAL GLAZE 10K 5%		R195	1-216-113-00	METAL GLAZE 470K 5%	1/10W
R124	1-216-073-00	METAL GLAZE 10K 5%		R196	1-216-073-00	METAL GLAZE 10K 5%	1/10W
R125	1-216-083-00	METAL GLAZE 27K 5%		R197	1-216-671-11	METAL CHIP 6.8K 0.50%	1/10W
R126	1-216-093-00	METAL GLAZE 68K 5%		R198	1-216-049-00	METAL GLAZE 1K 5%	1/10W
R127	1-216-037-00	METAL GLAZE 330 5%		R199	1-216-065-00	METAL GLAZE 4.7K 5%	1/10W
R128	1-216-083-00	METAL GLAZE 27K 5%		R200	1-216-065-00	METAL GLAZE 4.7K 5%	1/10W
R129	1-216-067-00	METAL GLAZE 5.6K 5%		R201	1-216-043-00	METAL GLAZE 560 5%	1/10W
R130	1-216-097-00	METAL GLAZE 100K 5%		R202	1-216-033-00	METAL GLAZE 220 5%	1/10W
R131	1-216-089-00	METAL GLAZE 47K 5%		R203	1-216-045-00	METAL GLAZE 680 5%	1/10W
R132	1-216-057-00	METAL GLAZE 2.2K 5%		R204	1-216-073-00	METAL GLAZE 10K 5%	1/10W
R133	1-216-079-00	METAL GLAZE 18K 5%		R205	1-216-073-00	METAL GLAZE 10K 5%	1/10W
R134	1-216-645-11	METAL CHIP 560 0.50%		R206	1-216-043-00	METAL GLAZE 560 5%	1/10W
R135	1-216-645-11	METAL CHIP 560 0.50%		R207	1-216-045-00	METAL GLAZE 680 5%	1/10W
R136	1-216-091-00	METAL GLAZE 56K 5%		R208	1-216-671-11	METAL CHIP 6.8K 0.50%	1/10W
R137	1-216-045-00	METAL GLAZE 680 5%		R209	1-216-043-00	METAL GLAZE 560 5%	1/10W
R138	1-216-657-11	METAL CHIP 1.8K 0.50%		R210	1-216-033-00	METAL GLAZE 220 5%	1/10W
R139	1-216-079-00	METAL GLAZE 18K 5%		R211	1-216-099-00	METAL GLAZE 120K 5%	1/10W
R140	1-216-653-11	METAL CHIP 1.2K 0.50%		R212	1-216-065-00	METAL GLAZE 4.7K 5%	1/10W
R141	1-216-063-00	METAL GLAZE 3.9K 5%		R213	1-216-043-00	METAL GLAZE 560 5%	1/10W
R142	1-216-073-00	METAL GLAZE 10K 5%		R214	1-216-043-00	METAL GLAZE 560 5%	1/10W
R143	1-216-085-00	METAL GLAZE 33K 5%		R215	1-216-127-11	METAL GLAZE 1.8M 5%	1/10W
R145	1-216-065-00	METAL GLAZE 4.7K 5%		R216	1-216-043-00	METAL GLAZE 560 5%	1/10W
R146	1-216-037-00	METAL GLAZE 330 5%		R217	1-216-033-00	METAL GLAZE 220 5%	1/10W
R147	1-216-089-00	METAL GLAZE 47K 5%		R218	1-216-295-00	METAL GLAZE 0 5%	1/10W
R148	1-216-671-11	METAL CHIP 6.8K 0.50%		R219	1-216-043-00	METAL GLAZE 560 5%	1/10W
R155	1-216-655-11	METAL CHIP 1.5K 0.50%		R220	1-216-043-00	METAL GLAZE 560 5%	1/10W
R157	1-216-679-11	METAL CHIP 15K 0.50%		R221	1-216-035-00	METAL GLAZE 270 5%	1/10W
R158	1-216-677-11	METAL CHIP 12K 0.50%		R222	1-216-033-00	METAL GLAZE 220 5%	1/10W
R160	1-216-065-00	METAL GLAZE 4.7K 5%		R223	1-216-073-00	METAL GLAZE 10K 5%	1/10W
R161	1-216-089-00	METAL GLAZE 47K 5%		R224	1-216-073-00	METAL GLAZE 10K 5%	1/10W
R163	1-216-073-00	METAL GLAZE 10K 5%		R225	1-216-095-00	METAL GLAZE 82K 5%	1/10W
R164	1-216-677-11	METAL CHIP 12K 0.50%		R226	1-216-073-00	METAL GLAZE 10K 5%	1/10W
R165	1-216-107-00	METAL GLAZE 270K 5%		R227	1-216-035-00	METAL GLAZE 270 5%	1/10W
R166	1-216-681-11	METAL CHIP 18K 0.50%		R228	1-216-065-00	METAL GLAZE 4.7K 5%	1/10W
				R229	1-216-113-00	METAL GLAZE 470K 5%	1/10W

B

REF. NO.	PART NO.	DESCRIPTION	REMARK	REF. NO.	PART NO.	DESCRIPTION	REMARK
R230	1-216-081-00	METAL GLAZE	22K 5% 1/10W	R301	1-216-065-00	METAL GLAZE	4.7K 5% 1/10W
R231	1-216-113-00	METAL GLAZE	470K 5% 1/10W	R302	1-216-113-00	METAL GLAZE	470K 5% 1/10W
R232	1-216-105-00	METAL GLAZE	220K 5% 1/10W	R303	1-216-065-00	METAL GLAZE	4.7K 5% 1/10W
R233	1-216-073-00	METAL GLAZE	10K 5% 1/10W	R304	1-216-049-00	METAL GLAZE	1K 5% 1/10W
R234	1-216-041-00	METAL GLAZE	470 5% 1/10W	R305	1-216-049-00	METAL GLAZE	1K 5% 1/10W
R235	1-216-041-00	METAL GLAZE	470 5% 1/10W	R306	1-216-089-00	METAL GLAZE	47K 5% 1/10W
R236	1-216-077-00	METAL GLAZE	15K 5% 1/10W	R307	1-216-033-00	METAL GLAZE	220 5% 1/10W
R237	1-216-025-00	METAL GLAZE	100 5% 1/10W	R308	1-216-089-00	METAL GLAZE	47K 5% 1/10W
R238	1-216-065-00	METAL GLAZE	4.7K 5% 1/10W	R309	1-216-089-00	METAL GLAZE	47K 5% 1/10W
R239	1-216-065-00	METAL GLAZE	4.7K 5% 1/10W	R310	1-216-033-00	METAL GLAZE	220 5% 1/10W
R240	1-216-033-00	METAL GLAZE	220 5% 1/10W	R311	1-216-089-00	METAL GLAZE	47K 5% 1/10W
R241	1-216-073-00	METAL GLAZE	10K 5% 1/10W	R312	1-216-089-00	METAL GLAZE	47K 5% 1/10W
R242	1-216-051-00	METAL GLAZE	1.2K 5% 1/10W	R313	1-216-033-00	METAL GLAZE	220 5% 1/10W
R243	1-216-113-00	METAL GLAZE	470K 5% 1/10W	R314	1-216-089-00	METAL GLAZE	47K 5% 1/10W
R244	1-216-065-00	METAL GLAZE	4.7K 5% 1/10W	R315	1-216-113-00	METAL GLAZE	470K 5% 1/10W
R245	1-216-679-11	METAL CHIP	15K 0.50% 1/10W	R316	1-216-105-00	METAL GLAZE	220K 5% 1/10W
R246	1-216-103-00	METAL GLAZE	180K 5% 1/10W	R317	1-216-109-00	METAL GLAZE	330K 5% 1/10W
R247	1-216-093-00	METAL GLAZE	68K 5% 1/10W	R318	1-216-105-00	METAL GLAZE	220K 5% 1/10W
R248	1-216-095-00	METAL GLAZE	82K 5% 1/10W	R319	1-216-099-00	METAL GLAZE	120K 5% 1/10W
R249	1-216-109-00	METAL GLAZE	330K 5% 1/10W	R320	1-216-099-00	METAL GLAZE	120K 5% 1/10W
R250	1-216-101-00	METAL GLAZE	150K 5% 1/10W	R321	1-216-043-00	METAL GLAZE	560 5% 1/10W
R251	1-216-105-00	METAL GLAZE	220K 5% 1/10W	R322	1-216-109-00	METAL GLAZE	330K 5% 1/10W
R252	1-216-101-00	METAL GLAZE	150K 5% 1/10W	R323	1-216-109-00	METAL GLAZE	330K 5% 1/10W
R253	1-216-101-00	METAL GLAZE	150K 5% 1/10W	R324	1-216-109-00	METAL GLAZE	330K 5% 1/10W
R254	1-216-033-00	METAL GLAZE	220 5% 1/10W	R325	1-216-097-00	METAL GLAZE	100K 5% 1/10W
R255	1-216-061-00	METAL GLAZE	3.3K 5% 1/10W	R326	1-216-113-00	METAL GLAZE	470K 5% 1/10W
R256	1-216-107-00	METAL GLAZE	270K 5% 1/10W	R328	1-216-073-00	METAL GLAZE	10K 5% 1/10W
R258	1-216-041-00	METAL GLAZE	470 5% 1/10W	R329	1-216-107-00	METAL GLAZE	270K 5% 1/10W
R259	1-216-073-00	METAL GLAZE	10K 5% 1/10W	R330	1-216-105-00	METAL GLAZE	220K 5% 1/10W
R260	1-216-025-00	METAL GLAZE	100 5% 1/10W	R331	1-216-025-00	METAL GLAZE	100 5% 1/10W
R261	1-216-035-00	METAL GLAZE	270 5% 1/10W	R332	1-216-097-00	METAL GLAZE	100K 5% 1/10W
R262	1-216-097-00	METAL GLAZE	100K 5% 1/10W	R333	1-216-097-00	METAL GLAZE	100K 5% 1/10W
R263	1-216-029-00	METAL GLAZE	150 5% 1/10W	R334	1-216-025-00	METAL GLAZE	100 5% 1/10W
R264	1-216-065-00	METAL GLAZE	4.7K 5% 1/10W	R335	1-216-099-00	METAL GLAZE	120K 5% 1/10W
R265	1-216-067-00	METAL GLAZE	5.6K 5% 1/10W	R336	1-216-095-00	METAL GLAZE	82K 5% 1/10W
R266	1-216-073-00	METAL GLAZE	10K 5% 1/10W	R337	1-216-105-00	METAL GLAZE	220K 5% 1/10W
R267	1-216-073-00	METAL GLAZE	10K 5% 1/10W	R338	1-216-025-00	METAL GLAZE	100 5% 1/10W
R268	1-216-081-00	METAL GLAZE	22K 5% 1/10W	R339	1-216-099-00	METAL GLAZE	120K 5% 1/10W
R269	1-216-103-00	METAL GLAZE	180K 5% 1/10W	R340	1-216-095-00	METAL GLAZE	82K 5% 1/10W
R270	1-216-081-00	METAL GLAZE	22K 5% 1/10W	R341	1-216-105-00	METAL GLAZE	220K 5% 1/10W
R271	1-216-025-00	METAL GLAZE	100 5% 1/10W	R342	1-216-047-00	METAL GLAZE	820 5% 1/10W
R272	1-216-103-00	METAL GLAZE	180K 5% 1/10W	R343	1-216-053-00	METAL GLAZE	1.5K 5% 1/10W
R273	1-216-113-00	METAL GLAZE	470K 5% 1/10W	R344	1-216-664-11	METAL CHIP	3.6K 0.50% 1/10W
R275	1-216-081-00	METAL GLAZE	22K 5% 1/10W	R345	1-216-661-11	METAL CHIP	2.7K 0.50% 1/10W
R276	1-216-037-00	METAL GLAZE	330 5% 1/10W	R346	1-216-105-00	METAL GLAZE	220K 5% 1/10W
R277	1-216-049-00	METAL GLAZE	1K 5% 1/10W	R348	1-216-061-00	METAL GLAZE	3.3K 5% 1/10W
R278	1-216-059-00	METAL GLAZE	2.7K 5% 1/10W	R349	1-216-650-11	METAL CHIP	910 0.50% 1/10W
R280	1-216-061-00	METAL GLAZE	3.3K 5% 1/10W	R350	1-216-653-11	METAL CHIP	1.2K 0.50% 1/10W
R281	1-216-061-00	METAL GLAZE	3.3K 5% 1/10W	R351	1-216-650-11	METAL CHIP	910 0.50% 1/10W
R282	1-216-037-00	METAL GLAZE	330 5% 1/10W	R352	1-216-653-11	METAL CHIP	1.2K 0.50% 1/10W
R283	1-216-049-00	METAL GLAZE	1K 5% 1/10W	R353	1-216-650-11	METAL CHIP	910 0.50% 1/10W
R284	1-216-059-00	METAL GLAZE	2.7K 5% 1/10W	R354	1-216-653-11	METAL CHIP	1.2K 0.50% 1/10W
R286	1-216-061-00	METAL GLAZE	3.3K 5% 1/10W	R355	1-216-113-00	METAL GLAZE	470K 5% 1/10W
R287	1-216-061-00	METAL GLAZE	3.3K 5% 1/10W	R356	1-216-113-00	METAL GLAZE	470K 5% 1/10W
R288	1-216-037-00	METAL GLAZE	330 5% 1/10W	R357	1-216-095-00	METAL GLAZE	82K 5% 1/10W
R289	1-216-049-00	METAL GLAZE	1K 5% 1/10W	R358	1-216-113-00	METAL GLAZE	470K 5% 1/10W
R290	1-216-059-00	METAL GLAZE	2.7K 5% 1/10W	R359	1-216-081-00	METAL GLAZE	22K 5% 1/10W
R292	1-216-061-00	METAL GLAZE	3.3K 5% 1/10W	R360	1-216-089-00	METAL GLAZE	47K 5% 1/10W
R293	1-216-061-00	METAL GLAZE	3.3K 5% 1/10W	R363	1-216-069-00	METAL GLAZE	6.8K 5% 1/10W
R295	1-216-057-00	METAL GLAZE	2.2K 5% 1/10W	R364	1-216-073-00	METAL GLAZE	10K 5% 1/10W
R296	1-216-659-11	METAL CHIP	2.2K 0.50% 1/10W	R365	1-216-073-00	METAL GLAZE	10K 5% 1/10W
R297	1-216-659-11	METAL CHIP	2.2K 0.50% 1/10W	R366	1-216-244-00	METAL GLAZE	82K 5% 1/8W
R298	1-216-065-00	METAL GLAZE	4.7K 5% 1/10W	R367	1-216-244-00	METAL GLAZE	82K 5% 1/8W
R300	1-216-065-00	METAL GLAZE	4.7K 5% 1/10W				

B

REF. NO.	PART NO.	DESCRIPTION	REMARK	REF. NO.	PART NO.	DESCRIPTION	REMARK
R368	1-216-055-00	METAL GLAZE	1.8K 5% 1/10W	R1040	1-216-025-00	METAL GLAZE	100 5% 1/10W
R369	1-216-248-00	METAL GLAZE	120K 5% 1/8W	R1042	1-216-047-00	METAL GLAZE	820 5% 1/10W
R370	1-216-115-00	METAL GLAZE	560K 5% 1/10W	R1043	1-216-057-00	METAL GLAZE	2.2K 5% 1/10W
R371	1-216-067-00	METAL GLAZE	5.6K 5% 1/10W	R1044	1-216-061-00	METAL GLAZE	3.3K 5% 1/10W
R372	1-216-115-00	METAL GLAZE	560K 5% 1/10W	R1045	1-216-125-00	METAL GLAZE	1.5M 5% 1/10W
R374	1-216-115-00	METAL GLAZE	560K 5% 1/10W	R1046	1-216-689-11	METAL CHIP	39K 0.50% 1/10W
R375	1-216-683-11	METAL CHIP	22K 0.50% 1/10W	R1047	1-216-065-00	METAL GLAZE	4.7K 5% 1/10W
R376	1-216-663-11	METAL CHIP	3.3K 0.50% 1/10W	R1048	1-216-049-00	METAL GLAZE	1K 5% 1/10W
R378	1-216-025-00	METAL GLAZE	100 5% 1/10W	R1049	1-216-085-00	METAL GLAZE	33K 5% 1/10W
R379	1-216-641-11	METAL CHIP	390 0.50% 1/10W	R1050	1-216-059-00	METAL GLAZE	2.7K 5% 1/10W
R380	1-216-668-11	METAL CHIP	5.1K 0.50% 1/10W	R1051	1-216-105-00	METAL GLAZE	220K 5% 1/10W
R381	1-216-089-00	METAL GLAZE	47K 5% 1/10W	R1053	1-216-091-00	METAL GLAZE	56K 5% 1/10W
R382	1-216-025-00	METAL GLAZE	100 5% 1/10W	R1054	1-216-093-00	METAL GLAZE	68K 5% 1/10W
R383	1-216-641-11	METAL CHIP	390 0.50% 1/10W	R1055	1-216-097-00	METAL GLAZE	100K 5% 1/10W
R384	1-216-668-11	METAL CHIP	5.1K 0.50% 1/10W	R1056	1-216-037-00	METAL GLAZE	330 5% 1/10W
R385	1-216-117-00	METAL GLAZE	680K 5% 1/10W	R1057	1-216-065-00	METAL GLAZE	4.7K 5% 1/10W
R386	1-216-025-00	METAL GLAZE	100 5% 1/10W	R1058	1-216-109-00	METAL GLAZE	330K 5% 1/10W
R387	1-216-641-11	METAL CHIP	390 0.50% 1/10W	R1059	1-216-109-00	METAL GLAZE	330K 5% 1/10W
R388	1-216-668-11	METAL CHIP	5.1K 0.50% 1/10W	R1060	1-216-109-00	METAL GLAZE	330K 5% 1/10W
R389	1-216-089-00	METAL GLAZE	47K 5% 1/10W	R1061	1-216-109-00	METAL GLAZE	330K 5% 1/10W
R390	1-216-105-00	METAL GLAZE	220K 5% 1/10W	R1062	1-216-103-00	METAL GLAZE	180K 5% 1/10W
R391	1-216-081-00	METAL GLAZE	22K 5% 1/10W	R1063	1-216-103-00	METAL GLAZE	180K 5% 1/10W
R392	1-216-113-00	METAL GLAZE	470K 5% 1/10W	R1064	1-216-103-00	METAL GLAZE	180K 5% 1/10W
R393	1-216-085-00	METAL GLAZE	33K 5% 1/10W	R1065	1-216-103-00	METAL GLAZE	180K 5% 1/10W
R394	1-216-113-00	METAL GLAZE	470K 5% 1/10W	R1066	1-216-073-00	METAL GLAZE	10K 5% 1/10W
R397	1-249-437-11	CARBON	47K 5% 1/4W F	R1067	1-216-073-00	METAL GLAZE	10K 5% 1/10W
R398	1-249-434-11	CARBON	27K 5% 1/4W F	R1068	1-216-049-00	METAL GLAZE	1K 5% 1/10W
R399	1-216-073-00	METAL GLAZE	10K 5% 1/10W	R1069	1-216-133-00	METAL GLAZE	3.3M 5% 1/10W
R1001	1-216-073-00	METAL GLAZE	10K 5% 1/10W	R1070	1-216-085-00	METAL GLAZE	33K 5% 1/10W
R1002	1-216-047-00	METAL GLAZE	820 5% 1/10W	R1071	1-216-113-00	METAL GLAZE	470K 5% 1/10W
R1003	1-216-055-00	METAL GLAZE	1.8K 5% 1/10W	R1072	1-216-099-00	METAL GLAZE	120K 5% 1/10W
R1004	1-216-061-00	METAL GLAZE	3.3K 5% 1/10W	R1073	1-216-131-11	METAL GLAZE	2.7M 5% 1/10W
R1005	1-216-047-00	METAL GLAZE	820 5% 1/10W	R1075	1-216-065-00	METAL GLAZE	4.7K 5% 1/10W
R1006	1-216-055-00	METAL GLAZE	1.8K 5% 1/10W	R1076	1-216-101-00	METAL GLAZE	150K 5% 1/10W
R1007	1-216-061-00	METAL GLAZE	3.3K 5% 1/10W	R1077	1-216-103-00	METAL GLAZE	180K 5% 1/10W
R1008	1-216-047-00	METAL GLAZE	820 5% 1/10W	R1079	1-216-131-11	METAL GLAZE	2.7M 5% 1/10W
R1009	1-216-053-00	METAL GLAZE	1.5K 5% 1/10W	R1080	1-216-097-00	METAL GLAZE	100K 5% 1/10W
R1010	1-216-061-00	METAL GLAZE	3.3K 5% 1/10W	R1081	1-216-097-00	METAL GLAZE	100K 5% 1/10W
R1011	1-216-033-00	METAL GLAZE	220 5% 1/10W	R1082	1-216-105-00	METAL GLAZE	220K 5% 1/10W
R1012	1-216-051-00	METAL GLAZE	1.2K 5% 1/10W	R1083	1-216-065-00	METAL GLAZE	4.7K 5% 1/10W
R1013	1-216-051-00	METAL GLAZE	1.2K 5% 1/10W	R1084	1-216-063-00	METAL GLAZE	3.9K 5% 1/10W
R1014	1-216-246-00	METAL GLAZE	100K 5% 1/8W	R1086	1-216-073-00	METAL GLAZE	10K 5% 1/10W
R1015	1-216-033-00	METAL GLAZE	220 5% 1/10W	R1087	1-216-121-00	METAL GLAZE	1M 5% 1/10W
R1016	1-216-089-00	METAL GLAZE	47K 5% 1/10W	R1088	1-216-047-00	METAL GLAZE	820 5% 1/10W
R1017	1-216-045-00	METAL GLAZE	680 5% 1/10W	R1090	1-216-049-00	METAL GLAZE	1K 5% 1/10W
R1018	1-216-043-00	METAL GLAZE	560 5% 1/10W	R1091	1-216-049-00	METAL GLAZE	1K 5% 1/10W
R1019	1-216-033-00	METAL GLAZE	220 5% 1/10W	R1092	1-216-049-00	METAL GLAZE	1K 5% 1/10W
R1020	1-216-089-00	METAL GLAZE	47K 5% 1/10W	R1093	1-216-121-00	METAL GLAZE	1M 5% 1/10W
R1021	1-216-045-00	METAL GLAZE	680 5% 1/10W	R1094	1-216-075-00	METAL GLAZE	12K 5% 1/10W
R1022	1-216-025-00	METAL GLAZE	100 5% 1/10W	R1095	1-216-075-00	METAL GLAZE	12K 5% 1/10W
R1023	1-216-073-00	METAL GLAZE	10K 5% 1/10W	R1096	1-216-075-00	METAL GLAZE	12K 5% 1/10W
R1024	1-216-025-00	METAL GLAZE	100 5% 1/10W	R1200	1-216-699-11	METAL CHIP	100K 0.50% 1/10W
R1025	1-216-033-00	METAL GLAZE	220 5% 1/10W	R1201	1-218-754-11	METAL CHIP	120K 0.50% 1/10W
R1026	1-216-061-00	METAL GLAZE	3.3K 5% 1/10W	R1207	1-216-061-00	METAL GLAZE	3.3K 5% 1/10W
R1027	1-216-101-00	METAL GLAZE	150K 5% 1/10W	R1208	1-216-065-00	METAL GLAZE	4.7K 5% 1/10W
R1028	1-216-033-00	METAL GLAZE	220 5% 1/10W	R1220	1-216-055-00	METAL GLAZE	1.8K 5% 1/10W
R1029	1-216-061-00	METAL GLAZE	3.3K 5% 1/10W	R1221	1-216-055-00	METAL GLAZE	1.8K 5% 1/10W
R1030	1-216-089-00	METAL GLAZE	47K 5% 1/10W	R1222	1-216-055-00	METAL GLAZE	1.8K 5% 1/10W
R1031	1-216-033-00	METAL GLAZE	220 5% 1/10W	R1223	1-216-689-11	METAL GLAZE	39K 5% 1/10W
R1032	1-216-061-00	METAL GLAZE	3.3K 5% 1/10W	R1225	1-215-876-00	METAL OXIDE	15K 5% 1W F
R1033	1-216-081-00	METAL GLAZE	22K 5% 1/10W	R1226	1-215-876-00	METAL OXIDE	15K 5% 1W F
R1035	1-216-073-00	METAL GLAZE	10K 5% 1/10W	R1227	1-215-876-00	METAL OXIDE	15K 5% 1W F
R1036	1-216-089-00	METAL GLAZE	47K 5% 1/10W	R1228	1-249-421-11	CARBON	2.2K 5% 1/4W F
R1038	1-216-081-00	METAL GLAZE	22K 5% 1/10W				

PVM-9041QM/9044QM

B **D**

REF. NO.	PART NO.	DESCRIPTION	REMARK	REF. NO.	PART NO.	DESCRIPTION	REMARK
R1229	1-249-421-11	CARBON	2.2K 5% 1/4W F	R1348	1-216-073-00	METAL GLAZE	10K 5% 1/10W
R1230	1-249-421-11	CARBON	2.2K 5% 1/4W F	R1349	1-216-073-00	METAL GLAZE	10K 5% 1/10W
R1231	1-216-029-00	METAL GLAZE	150 5% 1/10W	R1350	1-216-073-00	METAL GLAZE	10K 5% 1/10W
R1232	1-216-029-00	METAL GLAZE	150 5% 1/10W	R1351	1-216-073-00	METAL GLAZE	10K 5% 1/10W
R1233	1-216-029-00	METAL GLAZE	150 5% 1/10W	R1352	1-216-073-00	METAL GLAZE	10K 5% 1/10W
R1234	1-216-029-00	METAL GLAZE	150 5% 1/10W	R1353	1-216-115-00	METAL GLAZE	560K 5% 1/10W
R1235	1-216-029-00	METAL GLAZE	150 5% 1/10W	R1371	1-216-057-00	METAL GLAZE	2.2K 5% 1/10W
R1236	1-216-029-00	METAL GLAZE	150 5% 1/10W	R1372	1-216-057-00	METAL GLAZE	2.2K 5% 1/10W
R1237	1-249-419-11	CARBON	1.5K 5% 1/4W F	R1373	1-216-057-00	METAL GLAZE	2.2K 5% 1/10W
R1238	1-249-419-11	CARBON	1.5K 5% 1/4W F	R1392	1-216-089-00	METAL GLAZE	47K 5% 1/10W
R1239	1-249-419-11	CARBON	1.5K 5% 1/4W F	R1393	1-216-095-00	METAL GLAZE	82K 5% 1/10W
R1270	1-216-079-00	METAL GLAZE	18K 5% 1/10W	<VARIABLE RESISTOR>			
R1271	1-216-057-00	METAL GLAZE	2.2K 5% 1/10W	RV101	1-241-763-11	RES. ADJ. CERMET	4.7K
R1280	1-216-109-00	METAL GLAZE	330K 5% 1/10W	RV102	1-241-763-11	RES. ADJ. CERMET	4.7K
R1290	1-216-071-00	METAL GLAZE	8.2K 5% 1/10W	RV103	1-238-009-11	RES. ADJ. CARBON	220
R1291	1-216-081-00	METAL GLAZE	22K 5% 1/10W	RV104	1-238-009-11	RES. ADJ. CARBON	220
R1294	1-216-069-00	METAL GLAZE	6.8K 5% 1/10W	RV105	1-241-627-11	RES. ADJ. CARBON	1K
R1295	1-216-109-00	METAL GLAZE	330K 5% 1/10W	RV106	1-241-627-11	RES. ADJ. CARBON	1K
R1296	1-216-095-00	METAL GLAZE	82K 5% 1/10W	RV107	1-241-627-11	RES. ADJ. CARBON	1K
R1297	1-216-071-00	METAL GLAZE	8.2K 5% 1/10W	RV108	1-241-630-11	RES. ADJ. CARBON	10K
R1298	1-216-071-00	METAL GLAZE	8.2K 5% 1/10W	RV109	1-241-765-11	RES. ADJ. CERMET	22K
R1299	1-216-071-00	METAL GLAZE	8.2K 5% 1/10W	RV110	1-241-630-11	RES. ADJ. CARBON	10K
R1300	1-216-089-00	METAL GLAZE	47K 5% 1/10W	RV111	1-241-630-11	RES. ADJ. CARBON	10K
R1301	1-216-065-00	METAL GLAZE	4.7K 5% 1/10W	RV112	1-238-019-11	RES. ADJ. CARBON	47K
R1302	1-216-113-00	METAL GLAZE	470K 5% 1/10W	RV113	1-238-019-11	RES. ADJ. CARBON	47K
R1303	1-216-113-00	METAL GLAZE	470K 5% 1/10W	RV114	1-238-019-11	RES. ADJ. CARBON	47K
R1304	1-216-091-00	METAL GLAZE	56K 5% 1/10W	RV115	1-241-631-11	RES. ADJ. CARBON	22K
R1305	1-216-093-00	METAL GLAZE	68K 5% 1/10W	RV116	1-241-631-11	RES. ADJ. CARBON	22K
R1306	1-216-063-00	METAL GLAZE	3.9K 5% 1/10W	RV118	1-241-631-11	RES. ADJ. CARBON	22K
R1307	1-216-041-00	METAL GLAZE	470 5% 1/10W	RV119	1-241-631-11	RES. ADJ. CARBON	22K
R1308	1-216-041-00	METAL GLAZE	470 5% 1/10W	RV120	1-241-631-11	RES. ADJ. CARBON	22K
R1309	1-216-063-00	METAL GLAZE	3.9K 5% 1/10W	RV121	1-241-631-11	RES. ADJ. CARBON	22K
R1310	1-216-119-00	METAL GLAZE	820K 5% 1/10W	RV122	1-241-631-11	RES. ADJ. CARBON	22K
R1313	1-216-101-00	METAL GLAZE	150K 5% 1/10W	RV123	1-241-628-11	RES. ADJ. CARBON	2.2K
R1314	1-216-053-00	METAL GLAZE	1.5K 5% 1/10W	RV124	1-241-627-11	RES. ADJ. CARBON	1K
R1315	1-216-077-00	METAL GLAZE	15K 5% 1/10W	RV125	1-241-627-11	RES. ADJ. CARBON	1K
R1320	1-216-083-00	METAL GLAZE	27K 5% 1/10W	RV205	1-241-631-11	RES. ADJ. CARBON	22K
R1321	1-216-093-00	METAL GLAZE	68K 5% 1/10W	<MODULE>			
R1322	1-216-037-00	METAL GLAZE	330 5% 1/10W	SEP101	1-808-654-11	MODULE	
R1323	1-216-057-00	METAL GLAZE	2.2K 5% 1/10W	<CRYSTAL>			
R1324	1-216-121-00	METAL GLAZE	1M 5% 1/10W	X101	1-527-722-00	OSCILLATOR, CRYSTAL	
R1325	1-216-085-00	METAL GLAZE	33K 5% 1/10W	X102	1-577-259-11	VIBRATOR, CRYSTAL	
R1326	1-216-065-00	METAL GLAZE	4.7K 5% 1/10W	*****			
R1327	1-216-099-00	METAL GLAZE	120K 5% 1/10W	A-1346-018-A	D BOARD, COMPLETE	*****	
R1328	1-216-099-00	METAL GLAZE	120K 5% 1/10W	1-533-189-11	HOLDER, FUSE		
R1329	1-216-093-00	METAL GLAZE	68K 5% 1/10W	*3-738-015-01	COVER, (DIA. 6) CARBON VR		
R1330	1-216-063-00	METAL GLAZE	3.9K 5% 1/10W	4-382-854-01	SCREW (M3X8), P, SW (+)		
R1331	1-216-051-00	METAL GLAZE	1.2K 5% 1/10W	4-382-854-11	SCREW (M3X10), P, SW (+)		
R1332	1-216-057-00	METAL GLAZE	2.2K 5% 1/10W	<CAPACITOR>			
R1333	1-216-057-00	METAL GLAZE	2.2K 5% 1/10W	C501	1-124-477-11	ELECT	47MF 20% 16V
R1334	1-216-055-00	METAL GLAZE	1.8K 5% 1/10W	C502	1-124-907-11	ELECT	10MF 20% 50V
R1335	1-216-035-00	METAL GLAZE	270 5% 1/10W	C503	1-126-103-11	ELECT	470MF 20% 16V
R1336	1-216-089-00	METAL GLAZE	47K 5% 1/10W	C504	1-124-902-00	ELECT	0.47MF 20% 50V
R1337	1-216-113-00	METAL GLAZE	470K 5% 1/10W	C505	1-106-381-12	MYLAR	0.039MF 10% 100V
R1338	1-216-049-00	METAL GLAZE	1K 5% 1/10W				
R1339	1-216-097-00	METAL GLAZE	100K 5% 1/10W				
R1340	1-216-097-00	METAL GLAZE	100K 5% 1/10W				
R1341	1-216-111-00	METAL GLAZE	390K 5% 1/10W				
R1342	1-216-694-11	METAL CHIP	62K 0.50% 1/10W				
R1343	1-216-121-00	METAL GLAZE	1M 5% 1/10W				
R1344	1-216-073-00	METAL GLAZE	10K 5% 1/10W				
R1345	1-216-055-00	METAL GLAZE	1.8K 5% 1/10W				
R1346	1-216-047-00	METAL GLAZE	820 5% 1/10W				
R1347	1-216-073-00	METAL GLAZE	10K 5% 1/10W				

D

The components identified by shading and mark Δ are critical for safety. Replace only with part number specified.

REF. NO.	PART NO.	DESCRIPTION	REMARK	REF. NO.	PART NO.	DESCRIPTION	REMARK
D1608	8-719-977-02	DIODE DTZ5.6A		Q532	8-729-422-27	TRANSISTOR 2SD601A-Q	
D1609	8-719-977-49	DIODE DTZ15B		Q569	8-729-907-26	TRANSISTOR 1MX1	
D1610	8-719-404-46	DIODE MA110		Q576	8-729-920-48	TRANSISTOR 1MH2	
D1611	8-729-101-31	TRANSISTOR N13T1		Q579	8-729-920-48	TRANSISTOR 1MH2	
D1612	8-719-404-46	DIODE MA110		Q599	8-729-920-48	TRANSISTOR 1MH2	
D1615	8-719-404-46	DIODE MA110		Q833	8-729-216-22	TRANSISTOR 2SA1162-G	
D1617	8-719-977-49	DIODE DTZ15B		Q834	8-729-422-27	TRANSISTOR 2SD601A-Q	
D1618	8-719-977-49	DIODE DTZ15B		Q835	8-729-422-27	TRANSISTOR 2SD601A-Q	
D1620	8-719-400-18	DIODE MA152WK		Q836	8-729-255-12	TRANSISTOR 2SC2551-0	
D1621	8-719-510-12	DIODE D10SC4M		Q1601	8-729-422-27	TRANSISTOR 2SD601A-Q	
D1622	8-719-400-18	DIODE MA152WK		Q1602	8-729-422-27	TRANSISTOR 2SD601A-Q	
D1623	8-719-400-18	DIODE MA152WK		Q1603	8-729-422-27	TRANSISTOR 2SD601A-Q	
D1626	8-719-404-46	DIODE MA110		Q1604	8-729-216-22	TRANSISTOR 2SA1162-G	
D1627	8-719-404-46	DIODE MA110		Q1605	8-729-119-80	TRANSISTOR 2SC2688-LK	
D1628	8-719-404-46	DIODE MA110		Q1606	8-729-133-42	TRANSISTOR 2SC2334-L	
D1635	8-719-404-46	DIODE MA110		Q1607	8-729-422-27	TRANSISTOR 2SD601A-Q	
D1699	8-719-404-46	DIODE MA110		Q1608	8-729-422-27	TRANSISTOR 2SD601A-Q	
<FUSE>				Q1609	8-729-422-27	TRANSISTOR 2SD601A-Q	
F1601	Δ 1-532-777-21	FUSE, MICRO (SECONDARY) (1.25A/125V)		Q1610	8-729-422-27	TRANSISTOR 2SD601A-Q	
F1602	Δ 1-576-232-11	FUSE (H. B. C) (5.0A/250V)		Q1611	8-729-422-27	TRANSISTOR 2SD601A-Q	
<IC>				Q1612	8-729-422-27	TRANSISTOR 2SD601A-Q	
IC501	8-759-909-70	IC CX23025		Q1613	8-729-422-27	TRANSISTOR 2SD601A-Q	
IC502	8-759-100-60	IC UPC1377C		Q1614	8-729-422-27	TRANSISTOR 2SD601A-Q	
IC503	8-759-801-98	IC LA7830		Q1615	8-729-216-22	TRANSISTOR 2SA1162-G	
IC504	8-759-701-79	IC MC7812CT		Q1616	8-729-216-22	TRANSISTOR 2SA1162-G	
IC505	8-759-009-51	IC MC14538BF		Q1617	8-729-216-22	TRANSISTOR 2SA1162-G	
IC831	8-759-509-29	IC XRU4011BF		<RESISTOR>			
IC832	8-759-509-37	IC XRU4070BF		R501	1-216-089-00	METAL GLAZE 47K 5% 1/10W	
IC833	8-759-009-51	IC MC14538BF		R502	1-216-089-00	METAL GLAZE 47K 5% 1/10W	
IC1601	8-759-509-91	IC XRA10393F		R503	1-249-437-11	CARBON 47K 5% 1/4W F	
<JUMPER RESISTOR>				R504	1-216-073-00	METAL GLAZE 10K 5% 1/10W	
JR510	1-216-295-00	METAL GLAZE 0 5% 1/10W		R505	1-249-393-11	CARBON 10 5% 1/4W F	
<COIL>				R506	1-216-071-00	METAL GLAZE 8.2K 5% 1/10W	
L501	1-410-093-11	INDUCTOR 33MMH		R507	1-216-059-00	METAL GLAZE 2.7K 5% 1/10W	
L502	1-410-665-31	INDUCTOR 15UH		R508	1-216-085-00	METAL GLAZE 33K 5% 1/10W	
L503	1-424-625-11	COIL, CHOKE (PMC) 390UH		R509	1-216-687-11	METAL CHIP 33K 0.50% 1/10W	
L506	1-412-530-31	INDUCTOR 27UH		R510	1-216-683-11	METAL CHIP 22K 0.50% 1/10W	
L1601	1-459-155-00	COIL (WITH CORE) 47UH		R511	1-216-675-11	METAL CHIP 10K 0.50% 1/10W	
L1602	1-402-785-11	COIL, CHOKE 600UH		R512	1-218-761-11	METAL CHIP 240K 0.50% 1/10W	
L1603	1-410-397-21	FERRITE BEAD INDUCTOR		R513	1-216-065-00	METAL GLAZE 4.7K 5% 1/10W	
<TRANSISTOR>				R514	1-218-754-11	METAL CHIP 120K 0.50% 1/10W	
Q501	8-729-901-01	TRANSISTOR DTC144EK		R515	1-216-081-00	METAL GLAZE 22K 5% 1/10W	
Q502	8-729-901-01	TRANSISTOR DTC144EK		R516	1-216-073-00	METAL GLAZE 10K 5% 1/10W	
Q503	8-729-901-06	TRANSISTOR DTA144EK		R517	1-218-762-11	METAL CHIP 270K 0.50% 1/10W	
Q504	8-729-901-01	TRANSISTOR DTC144EK		R518	1-249-422-11	CARBON 2.7K 5% 1/4W F	
Q505	8-729-422-27	TRANSISTOR 2SD601A-Q		R519	1-216-085-00	METAL GLAZE 33K 5% 1/10W	
Q508	8-729-422-27	TRANSISTOR 2SD601A-Q		R520	1-216-677-11	METAL CHIP 12K 0.50% 1/10W	
Q509	8-729-422-27	TRANSISTOR 2SD601A-Q		R521	1-216-067-00	METAL GLAZE 5.6K 5% 1/10W	
Q510	8-729-901-06	TRANSISTOR DTA144EK		R522	1-216-107-00	METAL GLAZE 270K 5% 1/10W	
Q512	8-729-422-27	TRANSISTOR 2SD601A-Q		R523	1-216-081-00	METAL GLAZE 22K 5% 1/10W	
Q513	8-729-216-22	TRANSISTOR 2SA1162-G		R524	1-216-049-00	METAL GLAZE 1K 5% 1/10W	
Q514	8-729-216-22	TRANSISTOR 2SA1162-G		R525	1-216-434-11	METAL OXIDE 1.8K 5% 1W F	
Q515	8-729-313-42	TRANSISTOR 2SD1134-C		R526	1-216-079-00	METAL GLAZE 18K 5% 1/10W	
Q518	8-729-422-27	TRANSISTOR 2SD601A-Q		R527	1-249-437-11	CARBON 47K 5% 1/4W F	
Q519	8-729-422-27	TRANSISTOR 2SD601A-Q		R528	1-216-073-00	METAL GLAZE 10K 5% 1/10W	
				R529	1-216-073-00	METAL GLAZE 10K 5% 1/10W	
				R530	1-216-089-00	METAL GLAZE 47K 5% 1/10W	
				R531	1-216-089-00	METAL GLAZE 47K 5% 1/10W	
				R532	1-216-097-00	METAL GLAZE 100K 5% 1/10W	
				R533	1-216-089-00	METAL GLAZE 47K 5% 1/10W	

REF. NO.	PART NO.	DESCRIPTION	REMARK	REF. NO.	PART NO.	DESCRIPTION	REMARK
R534	1-216-097-00	METAL GLAZE	100K 5% 1/10W	R852	1-216-675-11	METAL CHIP	10K 0.50% 1/10W
R535	1-216-053-00	METAL GLAZE	1.5K 5% 1/10W	R853	1-216-105-00	METAL GLAZE	220K 5% 1/10W
R536	1-212-881-11	FUSIBLE	100 5% 1/4W F	R854	1-218-754-11	METAL CHIP	120K 0.50% 1/10W
R537	1-215-867-00	METAL OXIDE	470 5% 1W F	R855	1-216-697-11	METAL CHIP	82K 0.50% 1/10W
R538	1-216-095-00	METAL GLAZE	82K 5% 1/10W	R856	1-216-699-11	METAL CHIP	100K 0.50% 1/10W
R539	1-216-095-00	METAL GLAZE	82K 5% 1/10W	R857	1-216-686-11	METAL CHIP	30K 0.50% 1/10W
R540	1-216-101-00	METAL GLAZE	150K 5% 1/10W	R858	1-216-061-00	METAL GLAZE	3.3K 5% 1/10W
R541	1-216-063-00	METAL GLAZE	3.9K 5% 1/10W	R859	1-216-436-00	METAL OXIDE	3.9K 5% 1W F
R542	1-216-075-00	METAL GLAZE	12K 5% 1/10W	R860	1-216-675-11	METAL CHIP	10K 0.50% 1/10W
R543	1-216-065-00	METAL GLAZE	4.7K 5% 1/10W	R861	1-216-671-11	METAL CHIP	6.8K 0.50% 1/10W
R544	1-216-101-00	METAL GLAZE	150K 5% 1/10W	R862	1-216-675-11	METAL CHIP	10K 0.50% 1/10W
R545	1-216-041-00	METAL GLAZE	470 5% 1/10W	R863	1-249-435-11	CARBON	33K 5% 1/4W F
R546	1-216-091-00	METAL GLAZE	56K 5% 1/10W	R1503	1-216-049-00	METAL GLAZE	1K 5% 1/10W
R547	1-216-121-00	METAL GLAZE	1M 5% 1/10W	R1504	1-216-695-11	METAL CHIP	68K 0.50% 1/10W
R548	1-216-107-00	METAL GLAZE	270K 5% 1/10W	R1505	1-216-089-00	METAL GLAZE	47K 5% 1/10W
R549	1-216-101-00	METAL GLAZE	150K 5% 1/10W	R1506	1-216-667-11	METAL CHIP	4.7K 0.50% 1/10W
R550	1-216-356-00	METAL OXIDE	3.9 5% 1W F	R1507	1-216-081-00	METAL GLAZE	22K 5% 1/10W
R552	1-216-061-00	METAL GLAZE	3.3K 5% 1/10W	R1508	1-216-073-00	METAL GLAZE	10K 5% 1/10W
R553	1-216-689-11	METAL GLAZE	39K 5% 1/10W	R1509	1-216-065-00	METAL GLAZE	4.7K 5% 1/10W
R554	1-216-073-00	METAL GLAZE	10K 5% 1/10W	R1510	1-249-425-11	CARBON	4.7K 5% 1/4W F
R555	1-216-077-00	METAL GLAZE	15K 5% 1/10W	R1511	1-216-033-00	METAL GLAZE	220 5% 1/10W
R557	1-216-057-00	METAL GLAZE	2.2K 5% 1/10W	R1512	1-216-049-00	METAL GLAZE	1K 5% 1/10W
R558	1-216-049-00	METAL GLAZE	1K 5% 1/10W	R1513	1-216-017-00	METAL GLAZE	47 5% 1/10W
R559	1-216-065-00	METAL GLAZE	4.7K 5% 1/10W	R1519	1-216-031-00	METAL GLAZE	180 5% 1/10W
R560	1-216-037-00	METAL GLAZE	330 5% 1/10W	R1520	1-216-053-00	METAL GLAZE	1.5K 5% 1/10W
R561	1-216-081-00	METAL GLAZE	22K 5% 1/10W	R1601	1-216-685-11	METAL CHIP	27K 0.50% 1/10W
R562	1-216-053-00	METAL GLAZE	1.5K 5% 1/10W	R1602	1-216-681-11	METAL CHIP	18K 0.50% 1/10W
R563	1-216-061-00	METAL GLAZE	3.3K 5% 1/10W	R1603	1-216-671-11	METAL CHIP	6.8K 0.50% 1/10W
R564	1-249-415-11	CARBON	680 5% 1/4W F	R1604	1-249-433-11	CARBON	22K 5% 1/4W F
R565	1-216-059-00	METAL GLAZE	2.7K 5% 1/10W	R1605	1-216-070-00	METAL GLAZE	7.5K 5% 1/10W
R566	1-216-025-00	METAL GLAZE	100 5% 1/10W	R1606	1-216-070-00	METAL GLAZE	7.5K 5% 1/10W
R567	1-216-095-00	METAL GLAZE	82K 5% 1/10W	R1607	1-216-071-00	METAL GLAZE	8.2K 5% 1/10W
R568	1-216-063-00	METAL GLAZE	3.9K 5% 1/10W	R1608	1-216-065-00	METAL GLAZE	4.7K 5% 1/10W
R569	1-216-063-00	METAL GLAZE	3.9K 5% 1/10W	R1609	1-216-069-00	METAL GLAZE	6.8K 5% 1/10W
R570	1-216-093-00	METAL GLAZE	68K 5% 1/10W	R1610	1-216-057-00	METAL GLAZE	2.2K 5% 1/10W
R571	1-216-089-00	METAL GLAZE	47K 5% 1/10W	R1611	1-216-057-00	METAL GLAZE	2.2K 5% 1/10W
R572	1-216-095-00	METAL GLAZE	82K 5% 1/10W	R1612	1-215-913-11	METAL OXIDE	220 5% 3W F
R573	1-216-063-00	METAL GLAZE	3.9K 5% 1/10W	R1613	1-216-025-00	METAL GLAZE	100 5% 1/10W
R574	1-216-063-00	METAL GLAZE	3.9K 5% 1/10W	R1614	1-216-067-00	METAL GLAZE	5.6K 5% 1/10W
R575	1-216-105-00	METAL GLAZE	220K 5% 1/10W	R1615	1-216-657-11	METAL CHIP	1.8K 0.50% 1/10W
R576	1-216-109-00	METAL GLAZE	330K 5% 1/10W	R1616	1-216-629-11	METAL CHIP	120 0.50% 1/10W
R577	1-216-105-00	METAL GLAZE	220K 5% 1/10W	R1617	1-216-659-11	METAL CHIP	2.2K 0.50% 1/10W
R578	1-249-457-11	CARBON	6.8 5% 1/4W F	R1618	1-216-073-00	METAL GLAZE	10K 5% 1/10W
R579	1-249-457-11	CARBON	6.8 5% 1/4W F	R1620	1-216-065-00	METAL GLAZE	4.7K 5% 1/10W
R589	1-216-101-00	METAL GLAZE	150K 5% 1/10W	R1621	1-216-073-00	METAL GLAZE	10K 5% 1/10W
R591	1-216-063-00	METAL GLAZE	3.9K 5% 1/10W	R1622	1-216-073-00	METAL GLAZE	10K 5% 1/10W
R592	1-216-033-00	METAL GLAZE	220 5% 1/10W	R1623	1-216-073-00	METAL GLAZE	10K 5% 1/10W
R831	1-216-049-00	METAL GLAZE	1K 5% 1/10W	R1624	1-216-246-00	METAL GLAZE	100K 5% 1/8W
R832	1-216-075-00	METAL GLAZE	12K 5% 1/10W	R1625	1-216-061-00	METAL GLAZE	3.3K 5% 1/10W
R833	1-216-065-00	METAL GLAZE	4.7K 5% 1/10W	R1626	1-216-065-00	METAL GLAZE	4.7K 5% 1/10W
R834	1-216-059-00	METAL GLAZE	2.7K 5% 1/10W	R1627	1-216-049-00	METAL GLAZE	1K 5% 1/10W
R835	1-216-081-00	METAL GLAZE	22K 5% 1/10W	R1628	1-216-073-00	METAL GLAZE	10K 5% 1/10W
R836	1-216-049-00	METAL GLAZE	1K 5% 1/10W	R1629	1-216-683-11	METAL CHIP	22K 0.50% 1/10W
R837	1-216-075-00	METAL GLAZE	12K 5% 1/10W	R1630	1-216-683-11	METAL CHIP	22K 0.50% 1/10W
R838	1-216-049-00	METAL GLAZE	1K 5% 1/10W	R1631	1-216-057-00	METAL GLAZE	2.2K 5% 1/10W
R839	1-216-061-00	METAL GLAZE	3.3K 5% 1/10W	R1632	1-216-042-00	METAL GLAZE	510 5% 1/10W
R840	1-216-097-00	METAL GLAZE	100K 5% 1/10W	R1633	1-216-109-00	METAL GLAZE	330K 5% 1/10W
R841	1-216-093-00	METAL GLAZE	68K 5% 1/10W	R1634	1-216-099-00	METAL GLAZE	120K 5% 1/10W
R842	1-216-093-00	METAL GLAZE	68K 5% 1/10W	R1635	1-216-097-00	METAL GLAZE	100K 5% 1/10W
R843	1-216-065-00	METAL GLAZE	4.7K 5% 1/10W	R1636	1-216-073-00	METAL GLAZE	10K 5% 1/10W
R844	1-216-077-00	METAL GLAZE	15K 5% 1/10W	R1640	1-216-063-00	METAL GLAZE	3.9K 5% 1/10W
R847	1-216-049-00	METAL GLAZE	1K 5% 1/10W	R1641	1-216-073-00	METAL GLAZE	10K 5% 1/10W
R850	1-216-085-00	METAL GLAZE	33K 5% 1/10W	R1642	1-216-073-00	METAL GLAZE	10K 5% 1/10W
R851	1-216-669-11	METAL CHIP	5.6K 0.50% 1/10W				

PVM-9041QM/9044QM

• The components identified by **☒** in this manual have been carefully factory-selected for each set in order to satisfy regulations regarding X-ray radiation. Should replacement be required, replace only with the value originally used.

The components identified by shading and mark **△** are critical for safety. Replace only with part number specified.

D **S**

REF. NO.	PART NO.	DESCRIPTION	REMARK	REF. NO.	PART NO.	DESCRIPTION	REMARK
R1643	1-216-069-00	METAL GLAZE 6.8K 5%	1/10W	C1108	1-163-119-00	CERAMIC CHIP 120PF	5% 50V
R1644	1-216-069-00	METAL GLAZE 6.8K 5%	1/10W	C1109	1-163-031-11	CERAMIC CHIP 0.01MF	50V
R1645	1-216-073-00	METAL GLAZE 10K 5%	1/10W	C1110	1-163-117-00	CERAMIC CHIP 100PF	5% 50V
R1646	1-216-073-00	METAL GLAZE 10K 5%	1/10W	C1111	1-163-018-00	CERAMIC CHIP 0.0056MF	10% 50V
R1647	1-216-685-11	METAL CHIP 27K 0.50%	1/10W	C1112	1-126-160-11	ELECT 1MF	20% 50V
R1648	1-216-069-00	METAL GLAZE 6.8K 5%	1/10W	C1113	1-163-119-00	CERAMIC CHIP 120PF	5% 50V
R1649	1-216-069-00	METAL GLAZE 6.8K 5%	1/10W	C1114	1-163-103-00	CERAMIC CHIP 27PF	5% 50V
R1650	1-216-069-00	METAL GLAZE 6.8K 5%	1/10W	C1115	1-164-004-11	CERAMIC CHIP 0.1MF	10% 25V
R1651	1-216-069-00	METAL GLAZE 6.8K 5%	1/10W	C1116	1-163-114-00	CERAMIC CHIP 75PF	5% 50V
R1652	1-216-069-00	METAL GLAZE 6.8K 5%	1/10W	C1117	1-124-589-11	ELECT 47MF	20% 16V
R1653	1-216-069-00	METAL GLAZE 6.8K 5%	1/10W	C1118	1-164-004-11	CERAMIC CHIP 0.1MF	10% 25V
R1654	1-216-681-11	METAL CHIP 18K 0.50%	1/10W	C1119	1-163-020-00	CERAMIC CHIP 0.0082MF	10% 50V
R1655	1-216-081-00	METAL GLAZE 22K 5%	1/10W	C1120	1-163-097-00	CERAMIC CHIP 15PF	5% 50V
R1656	1-216-643-11	METAL CHIP 470 0.50%	1/10W	C1121	1-163-097-00	CERAMIC CHIP 15PF	5% 50V
R1657	1-216-081-00	METAL GLAZE 22K 5%	1/10W	C1122	1-163-222-11	CERAMIC CHIP 5PF	0.25PF 50V
R1658	1-216-063-00	METAL GLAZE 3.9K 5%	1/10W	C1123	1-163-097-00	CERAMIC CHIP 15PF	5% 50V
R1659	1-216-049-00	METAL GLAZE 1K 5%	1/10W	C1130	1-163-097-00	CERAMIC CHIP 15PF	5% 50V
R1660	1-216-649-11	METAL CHIP 820 0.50%	1/10W	C1131	1-163-097-00	CERAMIC CHIP 15PF	5% 50V
R1661	1-216-065-00	METAL GLAZE 4.7K 5%	1/10W				
<VARIABLE RESISTOR>				<CONNECTOR>			
RV501	1-238-019-11	RES, ADJ, CARBON 47K		CN1101	*1-565-488-11	CONNECTOR, BOARD TO BOARD 12P	
RV502	1-241-631-11	RES, ADJ, CARBON 22K		<DIODE>			
RV503	1-241-763-11	RES, ADJ, CERMET 4.7K		D1101	8-719-404-46	DIODE MA110	
RV504	1-224-250-XX	RES, ADJ, METAL GLAZE 2.2K		D1102	8-719-404-46	DIODE MA110	
RV505	1-238-009-11	RES, ADJ, CARBON 220		<IC>			
RV506	1-241-627-11	RES, ADJ, CARBON 1K		IC1101	8-752-056-67	IC CXA1214P	
RV507	1-241-628-11	RES, ADJ, CARBON 2.2K		<COIL>			
RV508	1-241-627-11	RES, ADJ, CARBON 1K		L1101	1-408-411-00	INDUCTOR 15UH	
RV509	1-238-021-11	RES, ADJ, CARBON 220K		L1102	1-404-496-00	COIL	
RV511	1-241-629-11	RES, ADJ, CARBON 4.7K		L1103	1-404-496-00	COIL	
RV512	1-241-629-11	RES, ADJ, CARBON 4.7K		L1104	1-408-411-00	INDUCTOR 15UH	
RV514	1-238-019-11	RES, ADJ, CARBON 47K		L1110	1-412-008-31	INDUCTOR CHIP 15UH	
RV515	1-238-021-11	RES, ADJ, CARBON 220K		L1111	1-412-008-31	INDUCTOR CHIP 15UH	
RV516	1-241-763-11	RES, ADJ, CERMET 4.7K		<TRANSISTOR>			
RV831	1-228-997-00	RES, ADJ, METAL GLAZE 100K		Q1101	8-729-216-22	TRANSISTOR 2SA1162-G	
RV832	1-241-764-11	RES, ADJ, CERMET 10K		Q1102	8-729-422-27	TRANSISTOR 2SD601A-Q	
☒RV833A	1-228-996-11	RES, ADJ, METAL GLAZE 47K		Q1103	8-729-216-22	TRANSISTOR 2SA1162-G	
RV1601	1-241-762-11	RES, ADJ, CERMET 2.2K		Q1104	8-729-216-22	TRANSISTOR 2SA1162-G	
RV1602	1-241-627-11	RES, ADJ, CARBON 1K		Q1105	8-729-901-01	TRANSISTOR DTC144EK	
☒RV1603A	1-228-996-11	RES, ADJ, METAL GLAZE 47K		Q1106	8-729-901-01	TRANSISTOR DTC144EK	
<RELAY>				Q1107	8-729-109-44	TRANSISTOR 2SK94	
RY1601	1-515-481-21	RELAY (G2R-212P-V)		Q1108	8-729-422-27	TRANSISTOR 2SD601A-Q	
<TRANSFORMER>				<RESISTOR>			
T1601	1-437-216-11	TRANSFORMER, DRIVE		R1101	1-216-053-00	METAL GLAZE 1.5K 5%	1/10W
*****				R1102	1-216-067-00	METAL GLAZE 5.6K 5%	1/10W
*A-1394-368-A	S BOARD, COMPLETE			R1103	1-216-059-00	METAL GLAZE 2.7K 5%	1/10W
*****				R1104	1-216-073-00	METAL GLAZE 10K 5%	1/10W
<CAPACITOR>				R1105	1-216-031-00	METAL GLAZE 180 5%	1/10W
C1101	1-163-119-00	CERAMIC CHIP 120PF	5% 50V	R1106	1-216-059-00	METAL GLAZE 2.7K 5%	1/10W
C1102	1-164-004-11	CERAMIC CHIP 0.1MF	10% 25V	R1107	1-216-071-00	METAL GLAZE 8.2K 5%	1/10W
C1103	1-124-589-11	ELECT 47MF	20% 16V	R1108	1-216-039-00	METAL GLAZE 390 5%	1/10W
C1104	1-163-031-11	CERAMIC CHIP 0.01MF	50V	R1109	1-216-063-00	METAL GLAZE 3.9K 5%	1/10W
C1105	1-163-114-00	CERAMIC CHIP 75PF	5% 50V	R1110	1-216-069-00	METAL GLAZE 6.8K 5%	1/10W
C1106	1-163-101-00	CERAMIC CHIP 22PF	5% 50V				
C1107	1-164-004-11	CERAMIC CHIP 0.1MF	10% 25V				

REF. NO.	PART NO.	DESCRIPTION	REMARK		
R1111	1-216-065-00	METAL GLAZE	4.7K	5%	1/10W
R1112	1-216-059-00	METAL GLAZE	2.7K	5%	1/10W
R1113	1-216-069-00	METAL GLAZE	6.8K	5%	1/10W
R1114	1-216-055-00	METAL GLAZE	1.8K	5%	1/10W
R1115	1-216-061-00	METAL GLAZE	3.3K	5%	1/10W
R1116	1-216-069-00	METAL GLAZE	6.8K	5%	1/10W
R1117	1-216-061-00	METAL GLAZE	3.3K	5%	1/10W
R1118	1-216-073-00	METAL GLAZE	10K	5%	1/10W
R1119	1-216-049-00	METAL GLAZE	1K	5%	1/10W
R1120	1-216-097-00	METAL GLAZE	100K	5%	1/10W
R1121	1-216-121-00	METAL GLAZE	1M	5%	1/10W
R1122	1-216-039-00	METAL GLAZE	390	5%	1/10W
R1123	1-216-065-00	METAL GLAZE	4.7K	5%	1/10W
R1124	1-216-029-00	METAL GLAZE	150	5%	1/10W
R1125	1-216-029-00	METAL GLAZE	150	5%	1/10W
R1126	1-216-053-00	METAL GLAZE	1.5K	5%	1/10W
R1127	1-216-043-00	METAL GLAZE	560	5%	1/10W
R1128	1-216-049-00	METAL GLAZE	1K	5%	1/10W
R1129	1-216-091-00	METAL GLAZE	56K	5%	1/10W
R1131	1-216-073-00	METAL GLAZE	10K	5%	1/10W
R1132	1-216-073-00	METAL GLAZE	10K	5%	1/10W
R1133	1-216-073-00	METAL GLAZE	10K	5%	1/10W
R1134	1-216-091-00	METAL GLAZE	56K	5%	1/10W

<VARIABLE RESISTOR>

RV1101	1-241-629-11	RES, ADJ, CARBON	4.7K
RV1102	1-241-628-11	RES, ADJ, CARBON	2.2K

<TRANSFORMER>

T1101	1-404-584-11	COIL
-------	--------------	------

PVM-9041QM/9044QM

PVM-9041QM/9044QM

SONY SERVICE MANUAL

AEP Model
PVM-9041QM
Chassis No. SCC-F09B-A
PVM-9044QM
Chassis No. SCC-F09A-A

SUPPLEMENT-3

File this supplement with the service manual.

INTRODUCTION

New Product, which have a changeover switch with both 16 : 9 and 4 : 3, has come from the following Serial Number.

Model	Serial Number
PVM-9041QM	2,500,001 and later
PVM-9044QM	2,500,001 and later



PVM-9041QM/9044QM

SPECIFICATIONS

Video signal

Color system	PVM-9044QM/9041QM: PAL, SECAM, NTSC, NTSC _{4.43}
Resolution	PVM-9044QM: 450 TV lines PVM-9041QM: 250 TV lines
Aperture correction	-4.0 dB - +6.0 dB (at 3.0 MHz)
Frequency response	6.0 MHz (-3.0 dB) at all inputs
Synchronization	AFC time constant 1.0 msec.

Picture performance

Normal scan	6% over scan of CRT effective screen area
Underscan	3% underscan of CRT effective screen area
H. linearity	Less than 7.0% (typical)
V. linearity	Less than 7.0% (typical)
Convergence	Central area: 0.43 mm (typical) Peripheral area: 0.53 mm (typical)
Raster size stability	H: 1.0%, V: 1.5%
High voltage regulation	3.0%
Color temperature	D65

Inputs and Outputs

Inputs	Y/C IN: 4-pin mini DIN connector (See the pin assignment on page 10.) VIDEO IN: BNC connector 1Vp-p ± 6 dB, sync negative AUDIO IN: phono jack, -5 dBs, less than 47k ohms R/R-Y, G/Y, B/B-Y: BNC connector R, G, B channels: 0.7 Vp-p, ±6 dB Sync on green: 0.3 Vp-p, negative, R-Y, Y, B-Y channels: 0.7 Vp-p, ±6 dB (Standard color bar signal of 100% chrominance) EXT SYNC IN: BNC connector Composite sync 4 Vp-p, ±6 dB, negative
--------	---

Loop-through outputs	Y/C OUT: 4-pin mini DIN connector, 75 ohms terminated VIDEO OUT: BNC connector, 75 ohms terminated AUDIO OUT: phono jack Output level 0.5 W EXT SYNC OUT: BNC connector, 75 ohms terminated
Remote input	REMOTE: 8-pin mini DIN connector (See the pin assignment on page 10.)

General

Power consumption	PVM-9044QM/9041QM 43 W at AC operation 40 W at DC operation
Power requirements	100 - 240 V AC, 50/60 Hz (for all models) 12 V DC, with the Sony (NP-1A/1B) battery pack (not supplied) or AC-550/550CE AC power adaptor (not supplied)
Operating temperature range	0 - 35°C
Storage temperature range	-10 - +40°C
Humidity	0 - 90%
Dimensions	Approx. 217 × 217 × 352.5 mm (w/h/d) (8 ⁵ / ₈ × 8 ⁵ / ₈ × 14 inches) not incl. projecting parts and controls
Weight	Approx. 7.8 kg (17 lb 3 oz) not incl. battery packs
Accessory supplied	AC power cord (1) Cable with an 8-pin connector (1) AC plug holders (1 set) Tally plate (1)

Design and specifications are subject to change without notice.

Pin Assignment

Y/C IN connector (4-pin mini DIN)

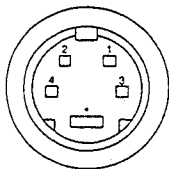

Pin No.	Signal	Description
1	Y-input	1 Vp-p, sync negative, 75 ohms
2	CHROMA sub-carrier-input	300 mVp-p, burst Delay time between Y and C: within 0±100 nsec., 75 ohms
3	GND for Y-input	GND
4	GND for CHROMA-input	GND

REMOTE connector (8-pin mini DIN)

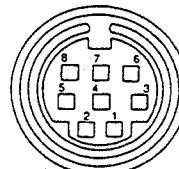

Pin No.	Signal
1	Blue only
2	H/V delay
3	GND
4	INT/EXT SYNC
5	Tally
6	Underscan/normal scan
7	A/B or RGB/Y R-Y B-Y
8	RGB/LINE

For remote control, connect the pin of the desired function to pin 3 (GND).

TABLE OF CONTENTS

<u>Section</u>	<u>Title</u>	<u>Page</u>	<u>Section</u>	<u>Title</u>	<u>Page</u>
1. GENERAL			6. DIAGRAMS		
1-1.	Features.....	4	6-1.	Block Diagrams (1).....	30
1-2.	Location and Function of Parts and Controls.....	5		Block Diagrams (2).....	34
1-3.	Power Sources.....	9	6-2.	Frame Schematic Diagram.....	39
2. DISASSEMBLY			6-3.	Circuit Boards Location.....	43
2-1.	Cabinet Removal.....	10	6-4.	Printed Wiring Boards and Schematic Diagrams.....	43
2-2.	B Board Removal.....	10		• D Board.....	44
2-3.	Switching Regulator Removal.....	11		• QA Board.....	55
2-4.	D Board Removal.....	11		• FA Board.....	56
2-5.	P Board Removal.....	12		• G Board.....	56
2-6.	Rear Assy Removal.....	12		• HA Board.....	56
2-7.	HA and FA Boards Removal.....	13		• X Board.....	56
2-8.	Picture Tube Removal.....	14		• CA Board.....	57
3. SET-UP ADJUSTMENTS				• P Board.....	57
3-1.	Beam Landing.....	15		• S Board.....	58
3-2.	Convergence.....	16		• B Board (1/2).....	59
3-3.	Focus.....	18		• B Board (2/2).....	63
3-4.	White Balance.....	18	6-5.	Semiconductors.....	69
4. SAFETY RELATED ADJUSTMENT			7. EXPLODED VIEWS		
4-1.	Safety Related Adjustments.....	19	7-1.	Chassis.....	71
5. CIRCUIT ADJUSTMENTS			7-2.	Picture Tube.....	72
5-1.	D Board Adjustments.....	21	8. ELECTRICAL PARTS LIST		73
5-2.	B Board Adjustment.....	24			
5-3.	S Board Adjustment.....	29			

SECTION 1 GENERAL

The operating instructions mentioned here are partial abstracts from the Operating Instruction Manual. The page numbers of the Operating Instruction Manual remain as in the manual.

1-1. FEATURES

Four color systems available

(PVM-9044QM/9041QM only)

The monitor can display PAL, SECAM, NTSC and NTSC_{4.43}¹⁾ signals. The appropriate color system is selected automatically.

HR (High Resolution) Trinitron^{®2)} picture tube

(PVM-9044QM only)

The HR Trinitron picture tube provides a high resolution picture. Horizontal resolution is more than 450 TV lines at the center of the picture.

Blue only picture

(PVM-9044QM/9041QM only)

The picture can be displayed in blue and black only. This facilitates hue adjustment and the observation of video noise.

Analog RGB/component input connectors

(PVM-9044QM/9041QM only)

Analog RGB or component (Y, R-Y and B-Y) signals from video equipment can be input through these connectors.

Y/C input connector

The video signal, split into the chrominance signal (C) and the luminance signal (Y), can be input through this connector, eliminating the interference between the two signals, which tends to occur in a composite video signal, assuring video quality.

Beam current feedback circuit

The built-in beam current feedback circuit assures stable white balance.

Comb filter

(PVM-9044QM/9041QM only)

When NTSC video signals are received, a comb filter activates to increase the resolution, resulting in fine picture detail without color spill or color noise.

Under scan 4:3/16:9 selector³⁾

(PVM-9044QM/9041QM only)

The monitor can display the 16:9 signal with the correct ratio of width and height, compressing the picture vertically. Selecting 16:9 with the UNDER SCAN 4:3/16:9 selector on the rear panel in the under scan mode changes the ratio of the picture to 16:9.

Automatic termination

(only connectors marked Ψ ⁴⁾)

The Y/C, VIDEO IN and EXT SYNC IN⁴⁾ connectors are terminated at 75 ohms inside, when no cable is connected to the loop-through output connectors. When a cable is connected to an output connector, the 75-ohm termination is automatically released.

EIA standard 19-inch rack mounting

By using an MB-507 mounting bracket (not supplied), the monitor can be mounted in an EIA standard 19-inch rack. For details on mounting, see the instruction manual of the MB-507.

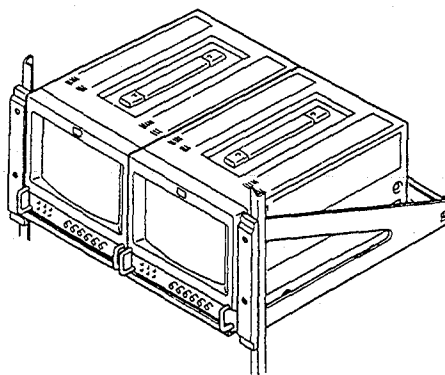

- 1) An NTSC_{4.43} signal is used for playing back NTSC-recorded video cassettes with a video tape recorder/player especially designed for use with this system.
- 2) Trinitron is a trademark of Sony Corporation.
- 3) The UNDER SCAN 4:3/16:9 selector and the Ψ mark have been adopted since the serial No. 2500001 product.
- 4) The EXT SYNC IN connector is provided with the PVM-9044QM/9041QM only.

1-2. LOCATION AND FUNCTION OF PARTS AND CONTROLS

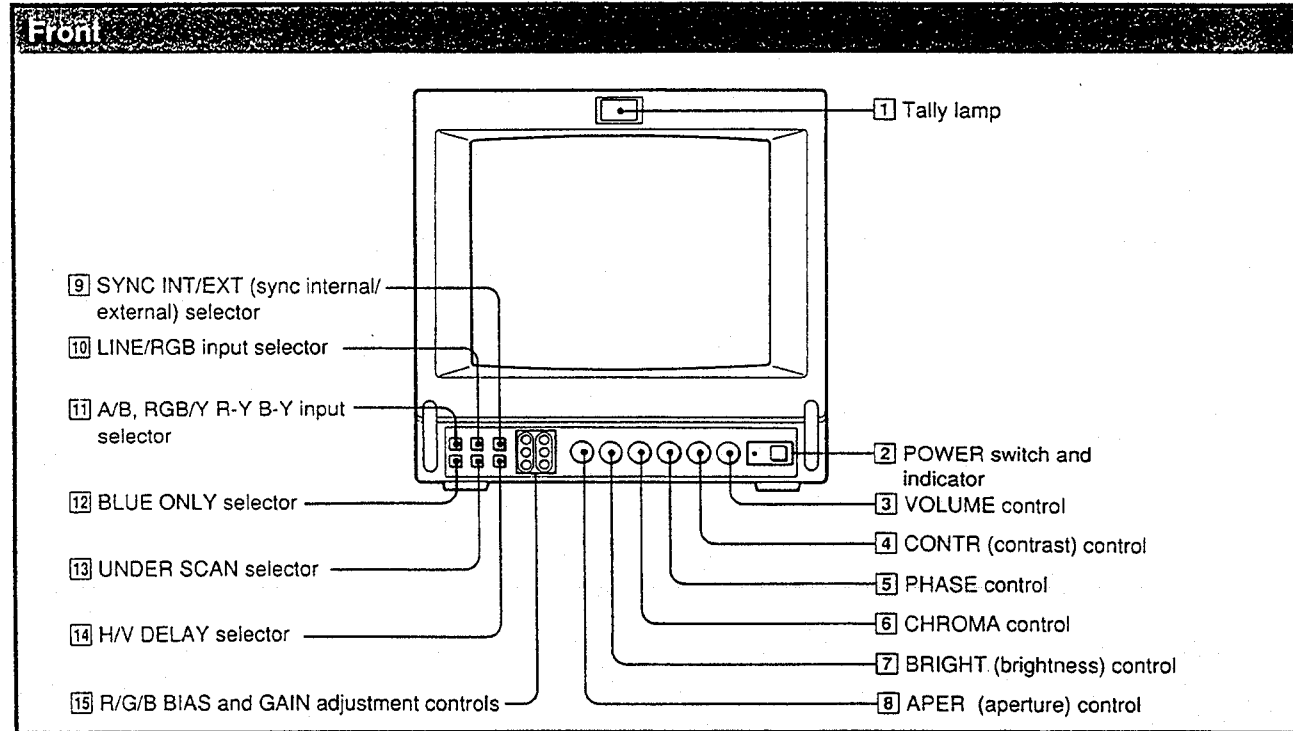

1 Tally lamp

2 POWER switch and indicator
Depress to turn the monitor on. The indicator will light up in green.
The POWER indicator also functions as the battery indicator. When the internal battery becomes weak or the power supplied through the DC12V IN jack decreases, the indicator flashes.

3 VOLUME control
Turn this control clockwise or counterclockwise to obtain the desired volume.

4 CONTR (contrast) control
Turn clockwise to make the contrast stronger and counterclockwise to make it weaker.

5 PHASE control
This control is effective only for the NTSC and NTSC_{4.43} color systems. Turn clockwise to make the skin tones greenish and counterclockwise to make them purplish.

6 CHROMA control
Turn clockwise to make the color intensity stronger and counterclockwise to make it weaker.

7 BRIGHT (brightness) control
Turn clockwise for more brightness and counterclockwise for less.

8 APER (aperture) control
Turn clockwise for more sharpness and counterclockwise for less.

Notes

- The PHASE, CHROMA and APER control settings have no effect on an analog RGB signal.
- The PHASE control has no effect on component signals.
- The PHASE control setting is effective only for the NTSC system.

9 SYNC INT/EXT (sync internal/external) selector
Keep this button released (INT) to operate the monitor on the sync signal from the displayed composite video signal.
Depress this button (EXT) to operate the monitor on an external sync signal fed through the EXT SYNC connector on the rear panel.

10 LINE/RGB input selector
Select the program to be monitored. Keep this button released (LINE) for a signal fed through the LINE A or LINE B connectors. Depress this button (RGB) for a signal fed through the RGB connectors.

11 A/B, RGB/Y R-Y B-Y input selector
When the LINE/RGB input selector is set to LINE, keep this button released (A) for a signal fed through the LINE A connectors. Depress this button (B) for a signal fed through the LINE B connectors.

When the LINE/RGB input selector is set to RGB, select the RGB signal or the component signal which is fed through the RGB input connectors. Keep this button released (RGB) for the RGB signal. Depress this button (Y R-Y B-Y) for the component signal.

12 BLUE ONLY selector
Depress this button to turn off the red and green signals. A blue signal is displayed as an apparent monochrome picture on the screen. This facilitates "chroma" and "phase" control adjustments and the observation of video noise.

13 UNDER SCAN selector
Depress this button for underscanning. The display size is reduced by approximately 3% so that four corners of the raster are visible.

With this button depressed, if the UNDER SCAN 4:3/16:9 selector on the rear panel is set to 16:9, the ratio of the picture changes to 16:9.

14 H/V DELAY selector
Depress this button to observe the horizontal and vertical sync signals at the same time. The horizontal sync signal is displayed in the left quarter of the screen; the vertical sync signal is displayed near the center of the screen.

15 R/G/B BIAS and GAIN adjustment controls
Used for white balance fine adjustment. BIAS and GAIN controls are provided for the R (red), G (green) and B (blue) screens.

BIAS: Adjust the white balance and brightness of the screen at the lowlight.

GAIN: Adjust the white balance and brightness of the screen at the highlight.

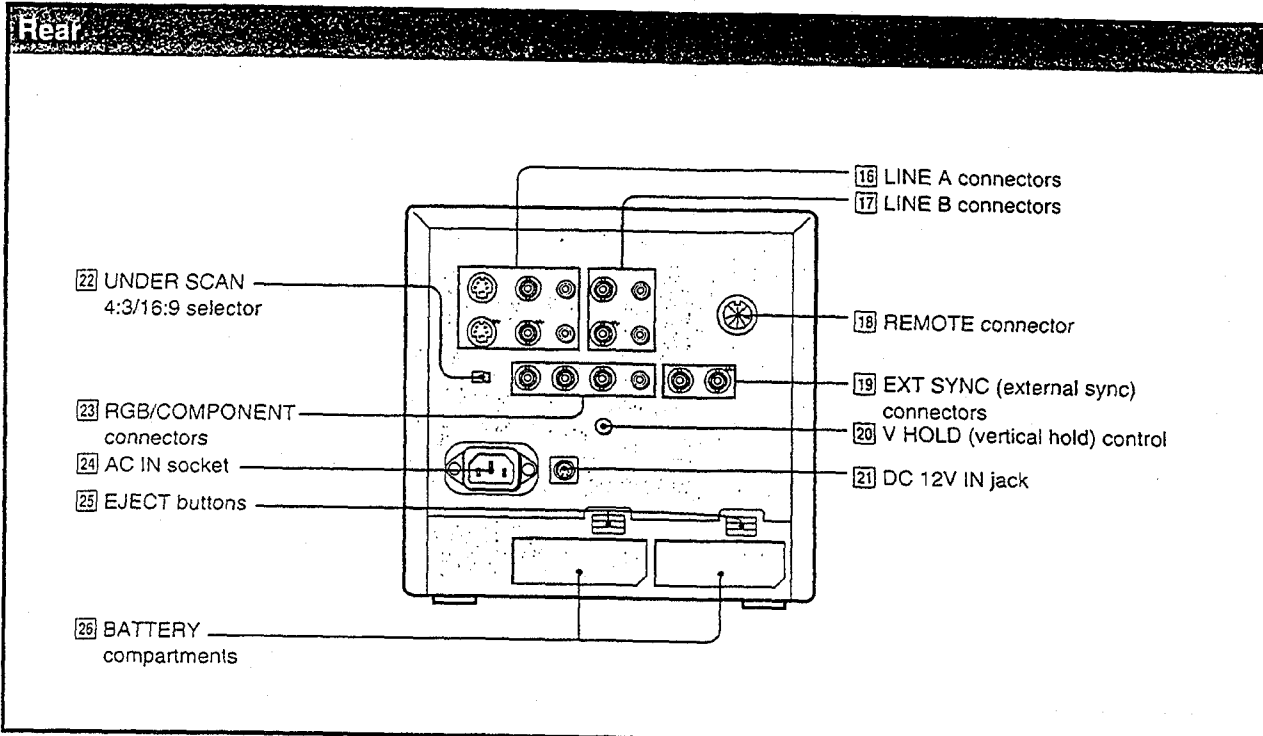

16 LINE A connectors

To monitor the signal fed through these connectors, keep the LINE/RGB selector and the A/B, RGB/Y R-Y B-Y selector on the front panel released (LINE and A).

17 LINE B connectors

To monitor the signal fed through these connectors, keep the LINE/RGB selector released (LINE) and depress the A/B, RGB/Y R-Y B-Y selector on the front panel (B).

VIDEO IN (BNC): Connect to the video output of a video camera, VCR or other video equipment.

VIDEO OUT (BNC): Loop-through output of the VIDEO IN connector. Connect to the video input of a VCR or another monitor.

AUDIO IN (phono jack): Connect to the audio output of a VCR or a microphone (through a suitable microphone amplifier).

AUDIO OUT (phono jack): Loop-through output of the AUDIO IN connector. Connect to the audio input of a VCR or another monitor.

18 REMOTE connector (8-pin mini DIN)

Connect to the tally output of a control console, special-effect generator, etc. The tally lamp on the front panel will be turned on and off by the connected equipment. This connector can be used for connecting a remote controller. For the pin assignment of this connector, see "Specifications" on page 10.

Note

The Y/C IN connector has a priority over the VIDEO IN connector.

When a plug is connected to the Y/C IN connector, the VIDEO IN connector is automatically disconnected.

19 EXT SYNC (external sync) connectors

IN (BNC): When this monitor operates on an external sync signal, connect the reference signal from a sync generator to this connector. In this case, depress the SYNC INT/EXT selector on the front panel (EXT).

OUT (BNC): Loop-through output of the EXT SYNC IN connector. Connect to the external sync input of video equipment to be synchronized with this monitor.

20 V HOLD (vertical hold) control

Turn to stabilize the picture if it rolls vertically.

21 DC 12V IN jack (XLR, 4 pin)

Connect the Sony AC-550/550CE AC power adaptor (not supplied).

22 UNDER SCAN 4:3/16:9 selector

Set to compress the picture vertically to monitor the 16:9 input signal with the correct ratio.

The function of the UNDER SCAN button on the front panel is changed by the position of this selector.

UNDER SCAN button 4:3/16:9 selector	Not depressed (□)	Depressed (■)
When the selector is set to 4:3	The 4:3 input signal is monitored with overscanning.	The 4:3 input signal is monitored with underscanning.
When the selector is set to 16:9	The 4:3 input signal is monitored with overscanning.	The 16:9 input signal is monitored with underscanning. (Compressed vertically)

The UNDER SCAN 4:3/16:9 selector has been adopted since the serial No. 2500001 product.

23 RGB/COMPONENT input connectors

R/R-Y, G/Y, B/B-Y (BNC), AUDIO (phono):

To monitor a signal fed through these connectors, depress the LINE/RGB selector on the front panel (RGB). When the SYNC INT/EXT selector on the front panel is released (INT), the monitor operates on the sync signal from the G/Y channel.

To monitor the analog RGB signal

Connect to the analog RGB signal outputs of a video camera. Keep the A/B, RGB/Y R-Y B-Y selector on the front panel released (RGB).

To monitor the component signal

Connect to the R-Y/Y/B-Y component signal outputs of a Sony BetaCam video camera. Depress the A/B, RGB/Y R-Y B-Y selector on the front panel (Y R-Y B-Y).

24 AC IN socket

Connect the supplied AC power cord to this socket and to a wall outlet.

25 EJECT buttons

Press the EJECT button upwards to remove the battery pack.

26 BATTERY compartments

Insert the NP-1A/1B battery pack (not supplied).

1-3. POWER SOURCES

House Current (for all models)

Connect the supplied AC power cord to the AC IN socket and to a wall outlet.

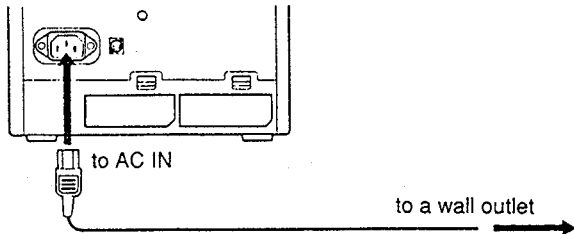

For the PVM-9044QM/9041QM

When the AC power cord is plugged into the AC IN socket, the battery pack (if installed) or the AC power adaptor (if connected) is automatically disconnected.

To connect an AC power cord securely with AC plug holders

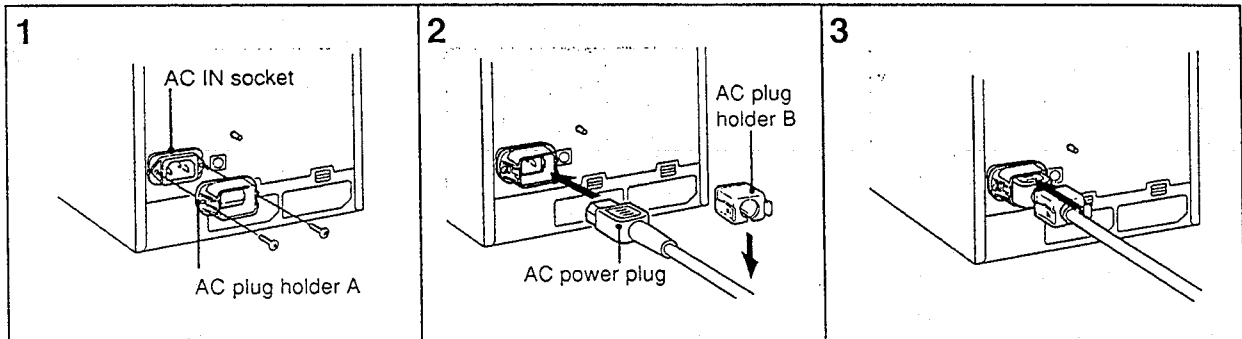

- 1 Remove the AC IN socket screws and then use them to attach the AC plug holder A (supplied) to the AC IN socket.
- 2 Plug the power cord to the AC IN socket. Then, attach the supplied AC plug holder B on top of the AC power cord.

- 3 Slide AC plug holder B over the cord until it locks.

To remove the AC power cord

Pull out AC plug holder B by squeezing the left and right sides.

Rechargeable Battery (PVM-9044QM/9041QM only)

The monitor can operate with one or two battery packs. For extended use, two battery packs are recommended.

To remove the battery pack, press the EJECT button upwards.

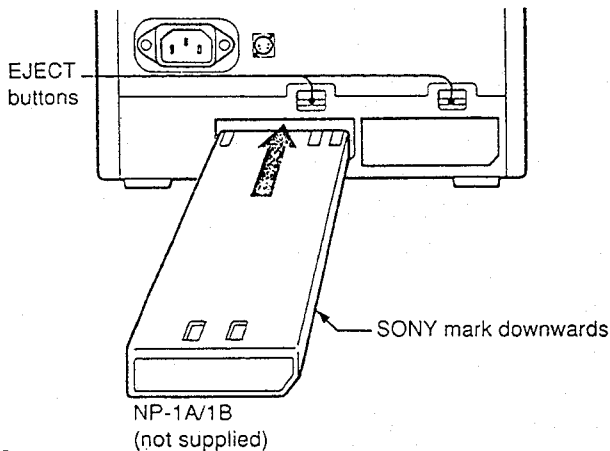

For charging, use the BC-1WA battery charger (not supplied) for the NP-1A or the BC-1WB for the NP-1B.

Note

Make sure that the AC power cord and the AC power adaptor are disconnected from the monitor. Otherwise, the monitor cannot operate on the battery pack(s).

SECTION 2 DISASSEMBLY

2-1. CABINET REMOVAL

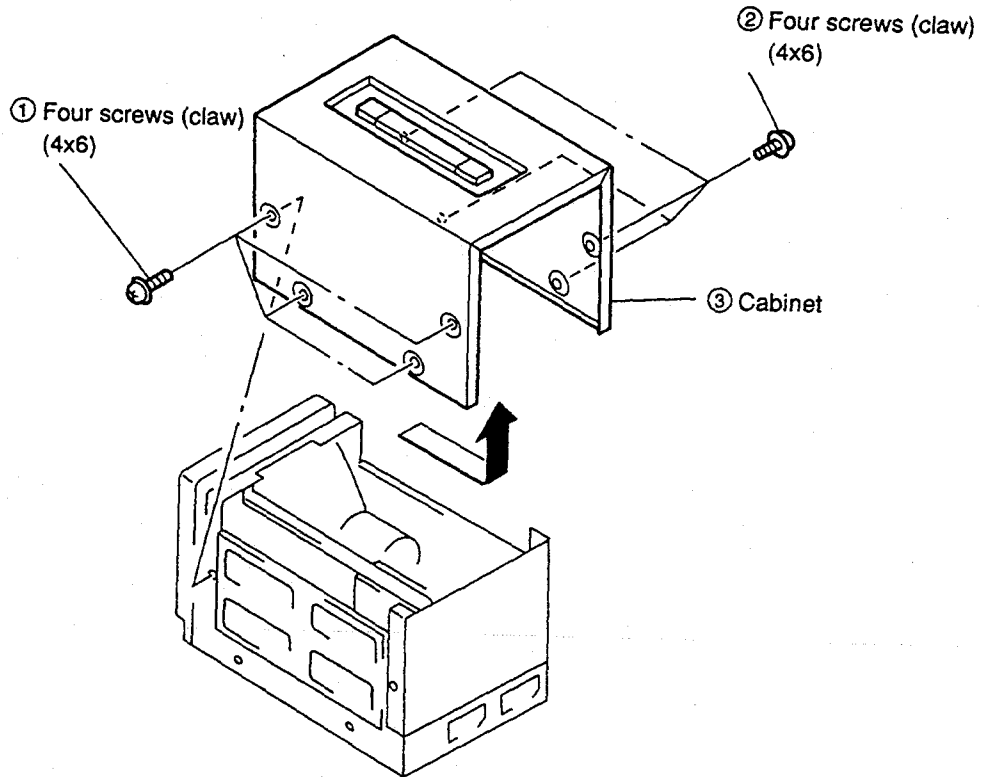

2-2. B BOARD REMOVAL

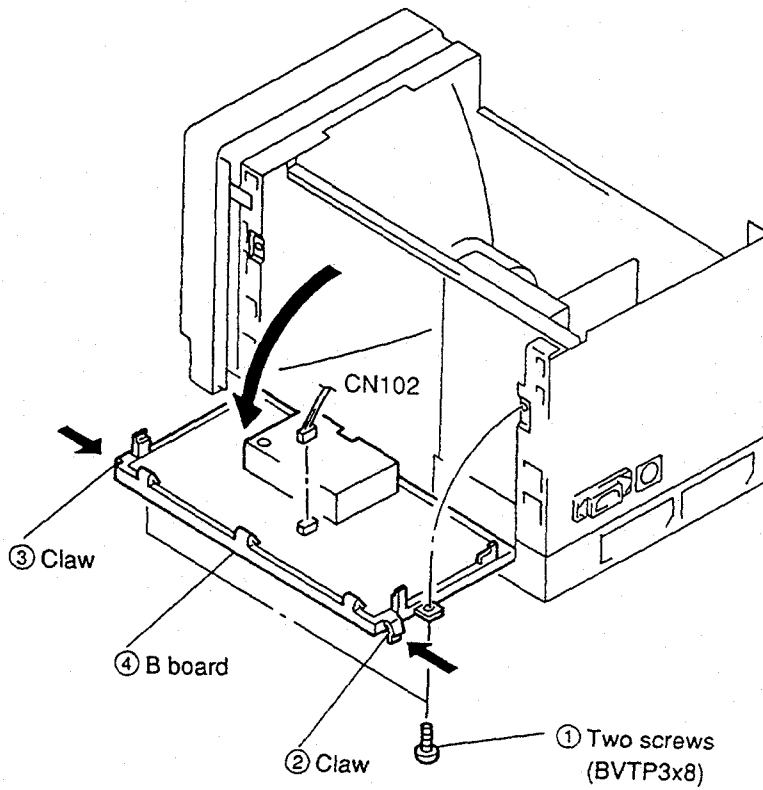

2-3. SWITCHING REGULATOR REMOVAL

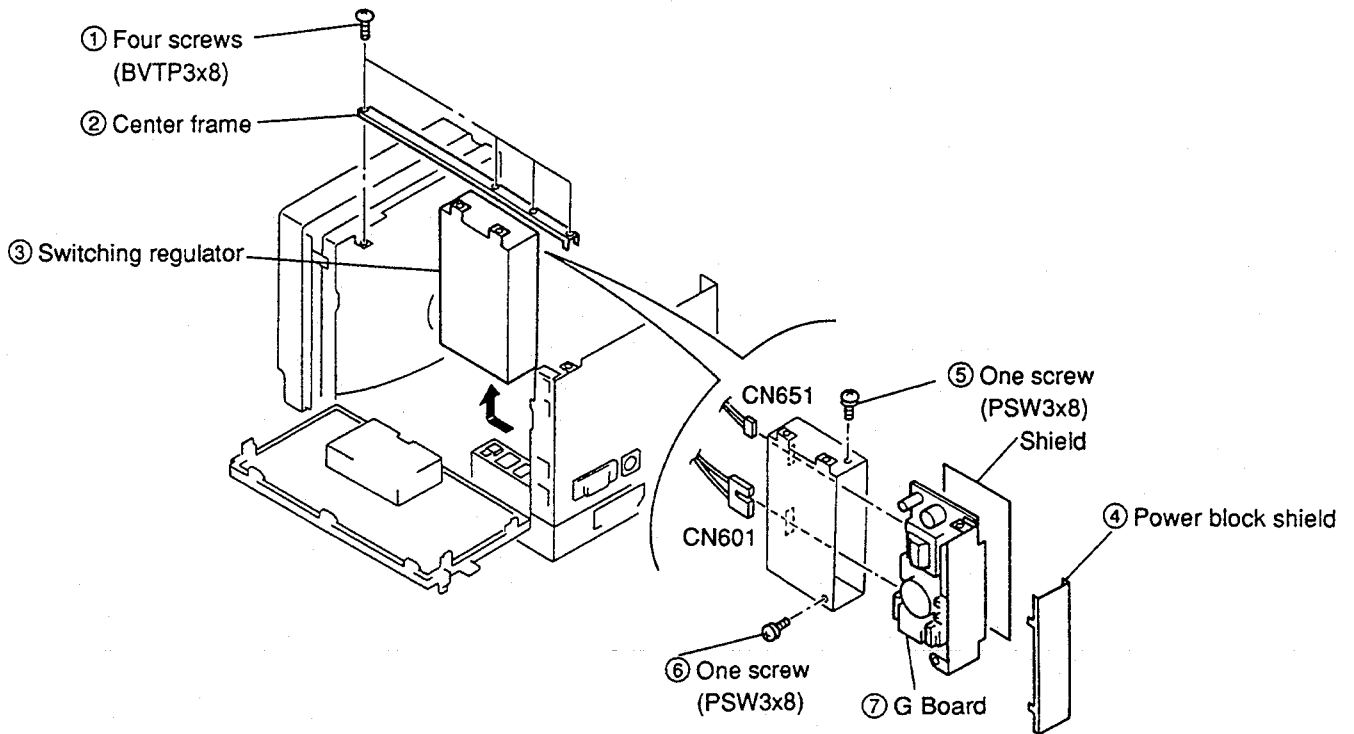

2-4. D BOARD REMOVAL

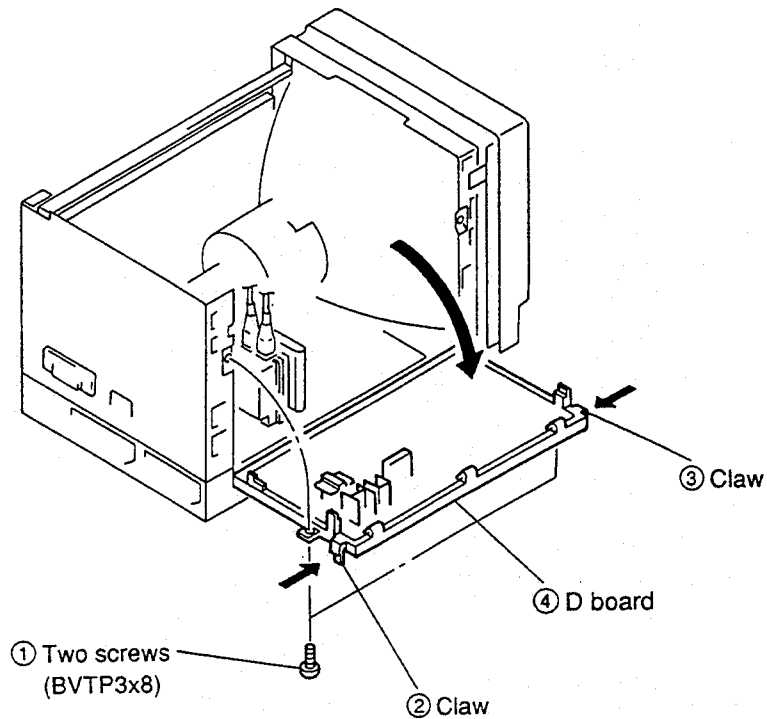

2-5. P BOARD REMOVAL

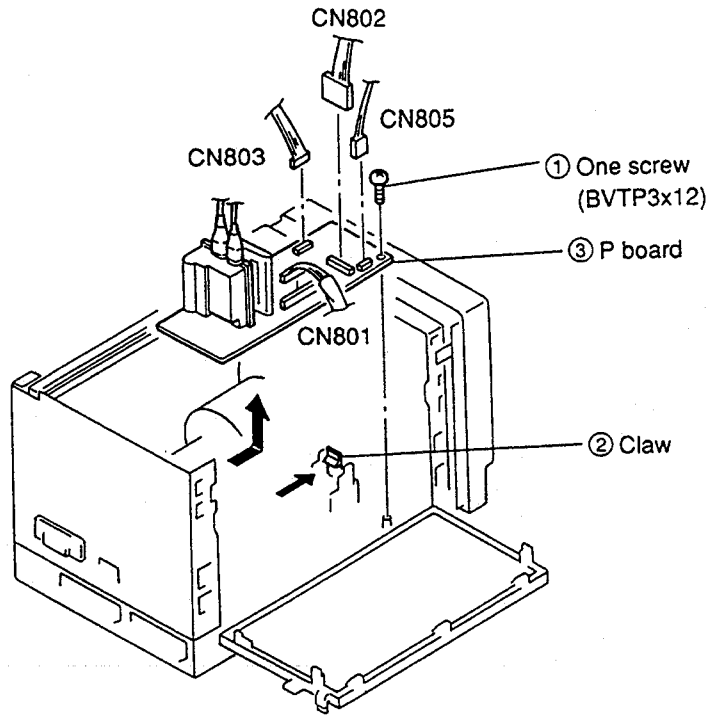

2-6. REAR ASSY REMOVAL

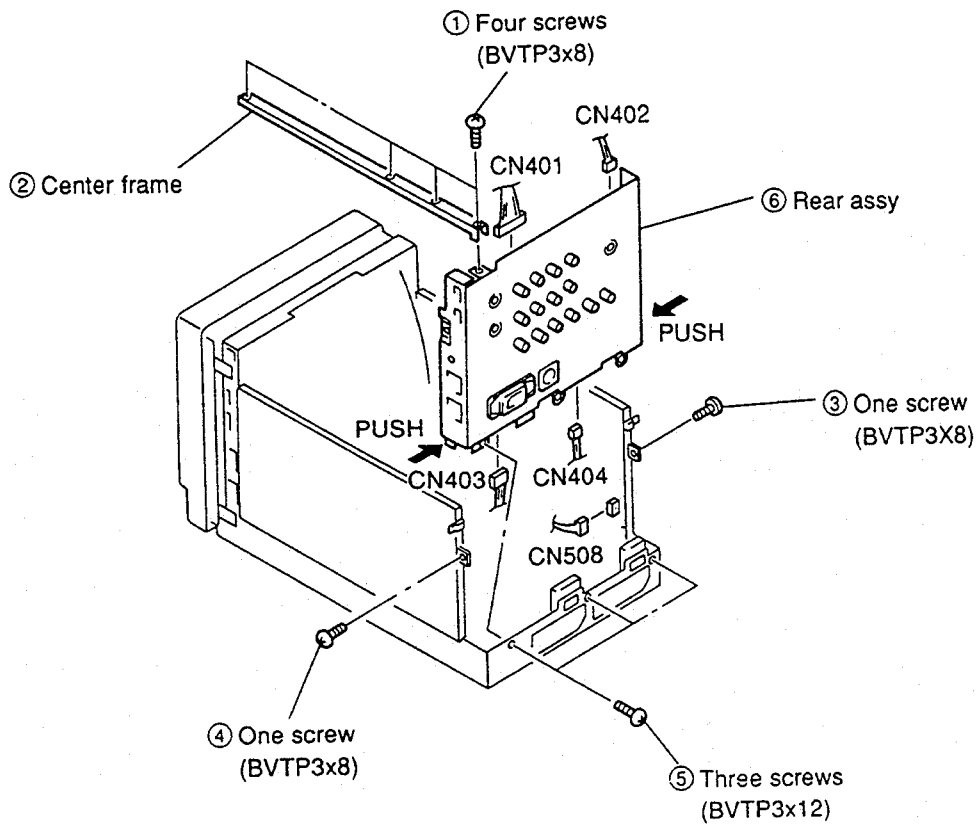

2-7. HA AND FA BOARDS REMOVAL

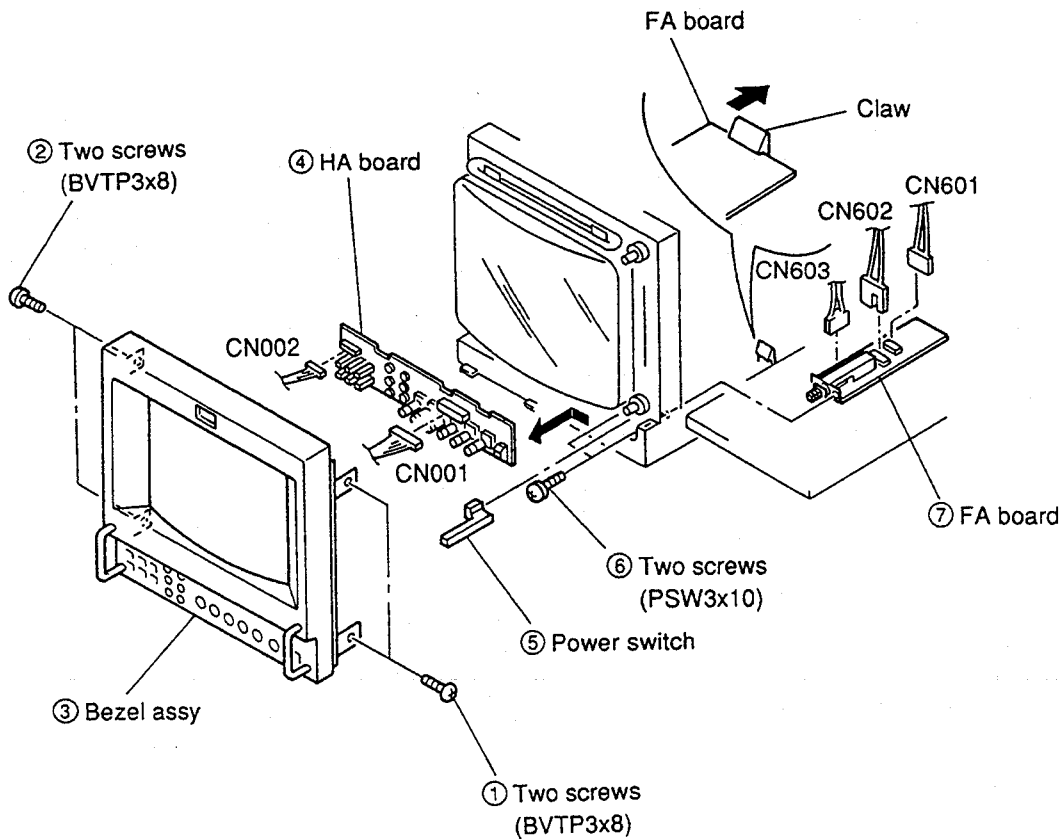

2-8. PICTURE TUBE REMOVAL

Note : Caution for ANODE CAP installation.

When you replace PICTURE TUBE or FBT, remove RTV on ANODE CAP so that PICTURE TUBE and FBT can be separated. Please adhere picture tube and anode cap in accordance with the following procedure.

ADHERING PROCEDURE OF ANODE CAP.

1. Clean PICTURE TUBE ANODE CAP with ethnaol to remove original RTV.
2. Dry clean face with air.

3. Use KE-490RTV (RTV silicone adhesive, SHIN-ETSU CHEMICAL).

Part. No.	Description
7-322-065-19	Silicone (RTV) KE-490W

4. Install ANODE CAP.
5. Adequately apply RTV to the entire picture tube anode area, place the anode cap onto the picture tube and push it down security so that no air pockets remain beneath the cap.
6. Dry more than 12 hours at room temperature.

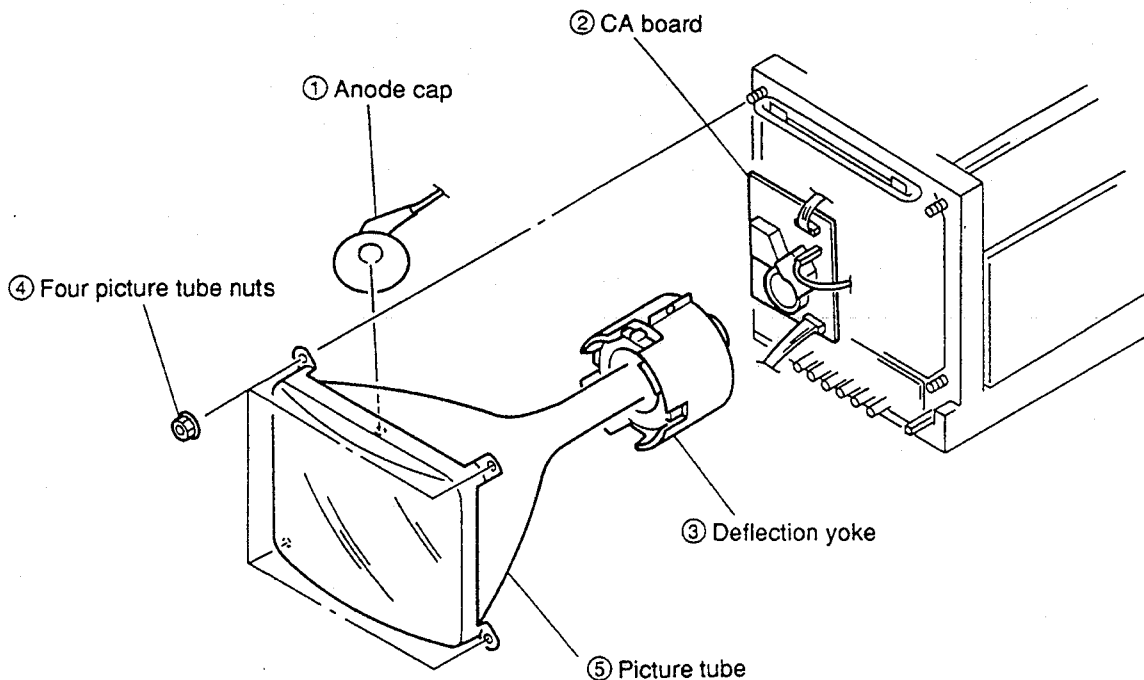

• **REMOVAL OF ANODE-CAP REMOVING PROCEDURES**

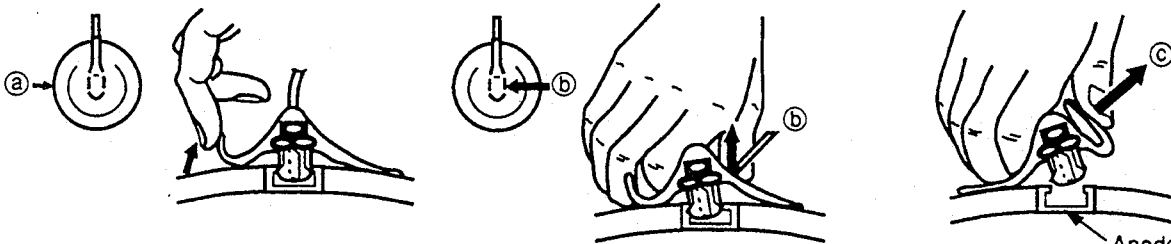

- ① Turn up one side of the rubber cap in the direction indicated by the arrow (a).
- ② Using a thumb pull up the rubber cap firmly in the direction indicated by the arrow (b).
- ③ When one side of the rubber cap is separated from the anode button, the anode-cap can be removed by turning up the rubber cap and pulling up it in the direction of the arrow (c).

• **HOW TO HANDLE AN ANODE-CAP**

- ① Don't hurt the surface of anode-caps with sharp shaped material!
- ② Don't press the rubber hardly not to hurt inside of anode-caps!
A metal fitting called as shatter-hook terminal is built in the rubber.
- ③ Don't turn the foot of rubber over hardly!

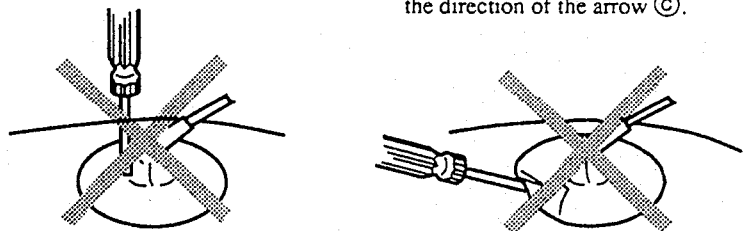

SECTION 3 SET-UP ADJUSTMENTS

- The following adjustments should be made when a complete realignment is required or a new picture tube is installed.
- These adjustments should be performed with rated power supply voltage unless otherwise noted.

Perform the adjustments in order as follows:

- 3-1. Beam Landing
- 3-2. Convergence
- 3-3. Focus
- 3-4. White Balance

The control and switch below should be set as follows unless otherwise noted:

CONTRAST control80%
 BRIGHTNESS control50%

Note: Test equipment Required.

1. Color Bar/Pattern Generator
2. Degausser
3. Color Analyzer (Minolta)
4. Luminance Level Meter

3-1. BEAM LANDING

Precaution

1. Set the side of the unit with the PICTURE TUBE so that it faces east or west in order to reduce the influence of external magnetic force.
2. Turn the power switch for the unit ON and erase the magnetic force using a degausser.

(1) Beam Landing

1. Receive an entirely white signal with the pattern generator.
 CONTRASTMAX.
 BRIGHTNESS..... set easy to observe
2. Adjust the white balance, G2 voltage and convergence roughly.
3. Loosen the deflection yoke mounting screw, and set the purity control to the center as shown in Fig.3-1.
4. Switch over the pattern generator to green.
5. Move the deflection yoke backward, and adjust with the purity control so that green is in the center and blue and red are at the sides, evenly. (Fig.3-2)
6. Move the deflection yoke forward, and adjust so that the entire screen becomes green. Repeat 5 to 7 as to red and blue.
7. When landing at the corners is not right, correct by using the magnet. (Fig.3-3)
8. When the position of the deflection yoke is determined, tighten it with a deflection yoke mounting screw.

CAUTION: When correction magnet is used, be sure to degauss the unit.

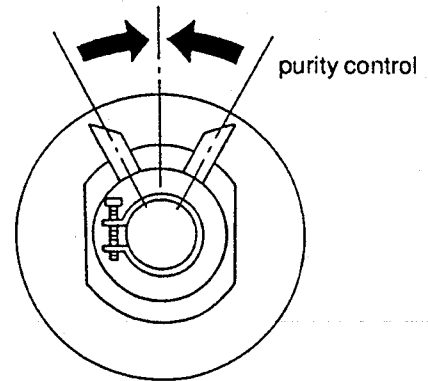

Fig.3-1

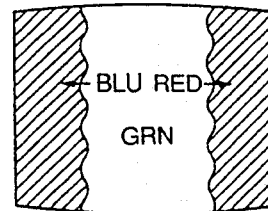

Fig.3-2

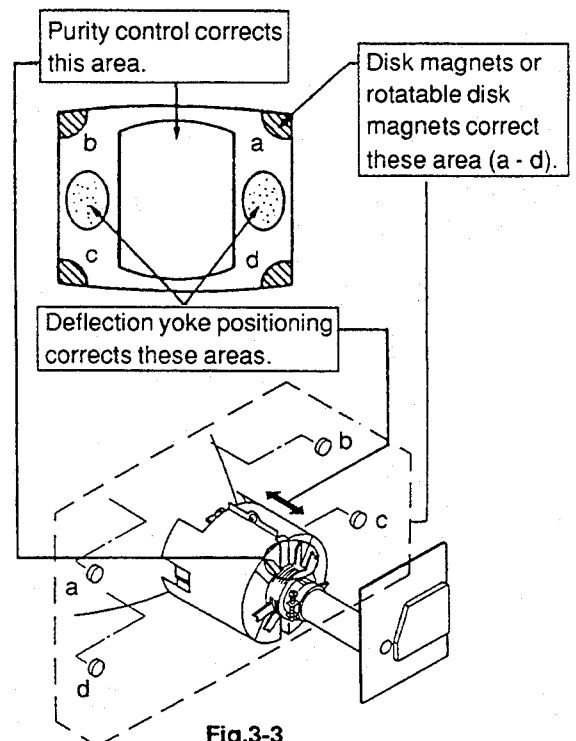
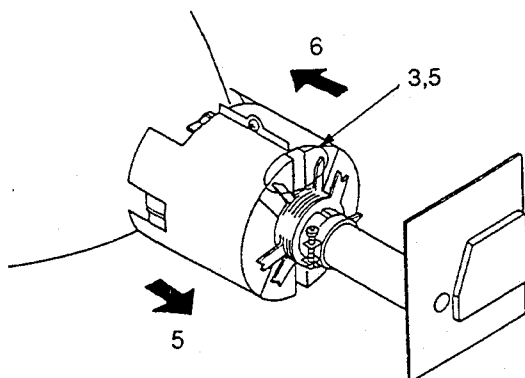

Fig.3-3

3-2. CONVERGENCE

(1) Horizontal and vertical Static Convergence Adjustment on the Center of Screen.

- Before starting, perform V. SIZE, V. CENT, H.SIZE, H.CENT and Screen Distortion Adjustment rightly.

(Static Convergence Adjustment)

1. Receive a dot signal, setting BRIGHTNESS minimum and set CONTRAST to normal.
2. Adjust H.STAT VR to coincide red, green and blue dots on the center of screen. (Horizontal movement)
3. Adjust V.STAT magnet to coincide red, green and blue dots on the center of screen. (Vertical movement)

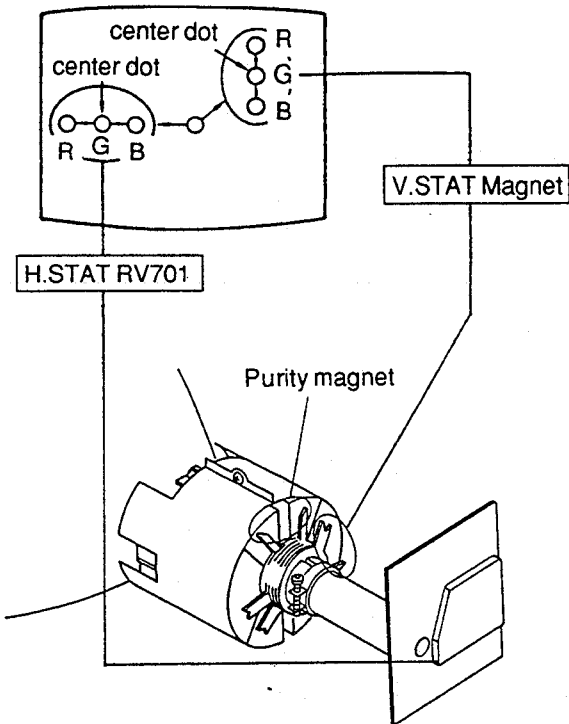

4. When the V.STAT magnet is moved in the direction of arrow A and b, red, green and blue dots move as shown below.

① When moving the V.STAT Magnet open or close.

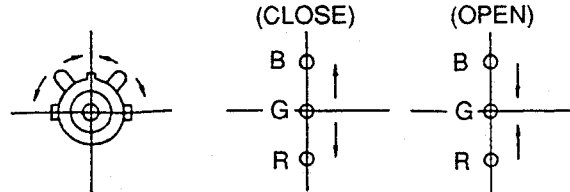

② When moving the V.STAT magnet counterclockwise.

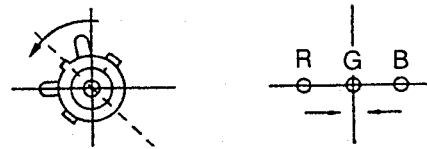

③ When moving the V.STAT magnet clockwise.

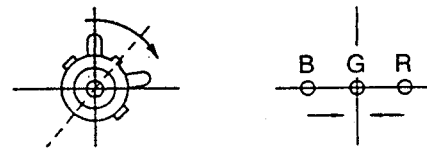

④ When tilt the V.STAT magnet and open or close.

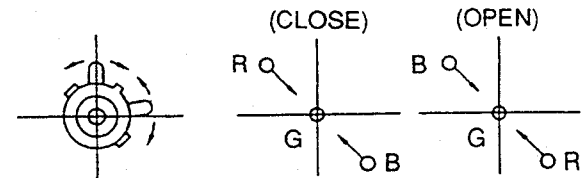

* If the red and green dots do not coincide with blue dot, adjustment with BMC (6-poles) magnet.

5. HMC and VMC correction for BMC (6-Poles) magnet.

① HMC (Horizontal Misconvergence) correction and motion of the Electron Beam with the BMC (6-poles) magnet.

* If the red, green and blue dots do not coincide on the center of screen with H.STAT VR, perform adjustment using V.STAT at the same time while tracking. (Tilt the V.STAT magnet and adjust static convergence to open or close the V.STAT magnet.)

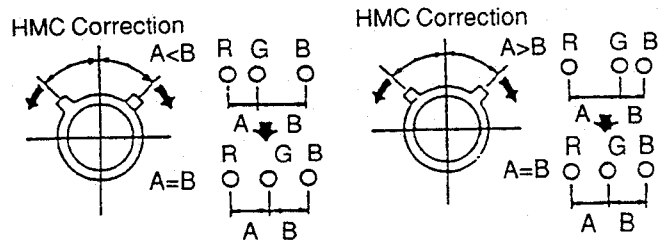
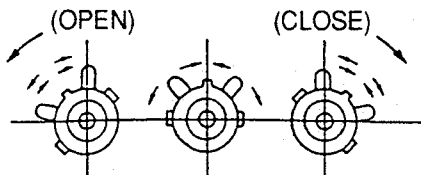

② VMC (Vertical Misconvergence) correction and motion of the Electron Beam with the BMC (6-poles) magnet.

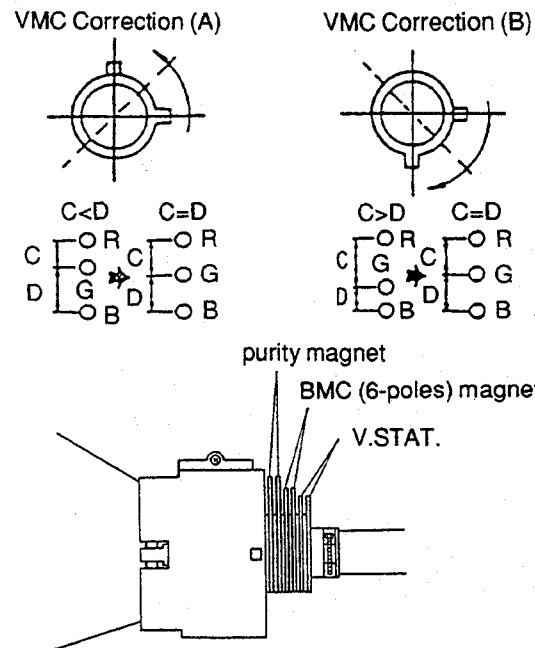

(2) Horizontal and Vertical Dynamic Convergence Adjustment at the Environs of the Screen (Dynamic Convergence Adjustment)

- When there is misconvergence at the sides of screen, adjust for best convergence as follows by moving the deflection yoke.
- Loosen deflection yoke screw. Remove deflection yoke spacers. Move the deflection yoke for best convergence. Tighten the deflection yoke screw. Install three deflection yoke spacers.

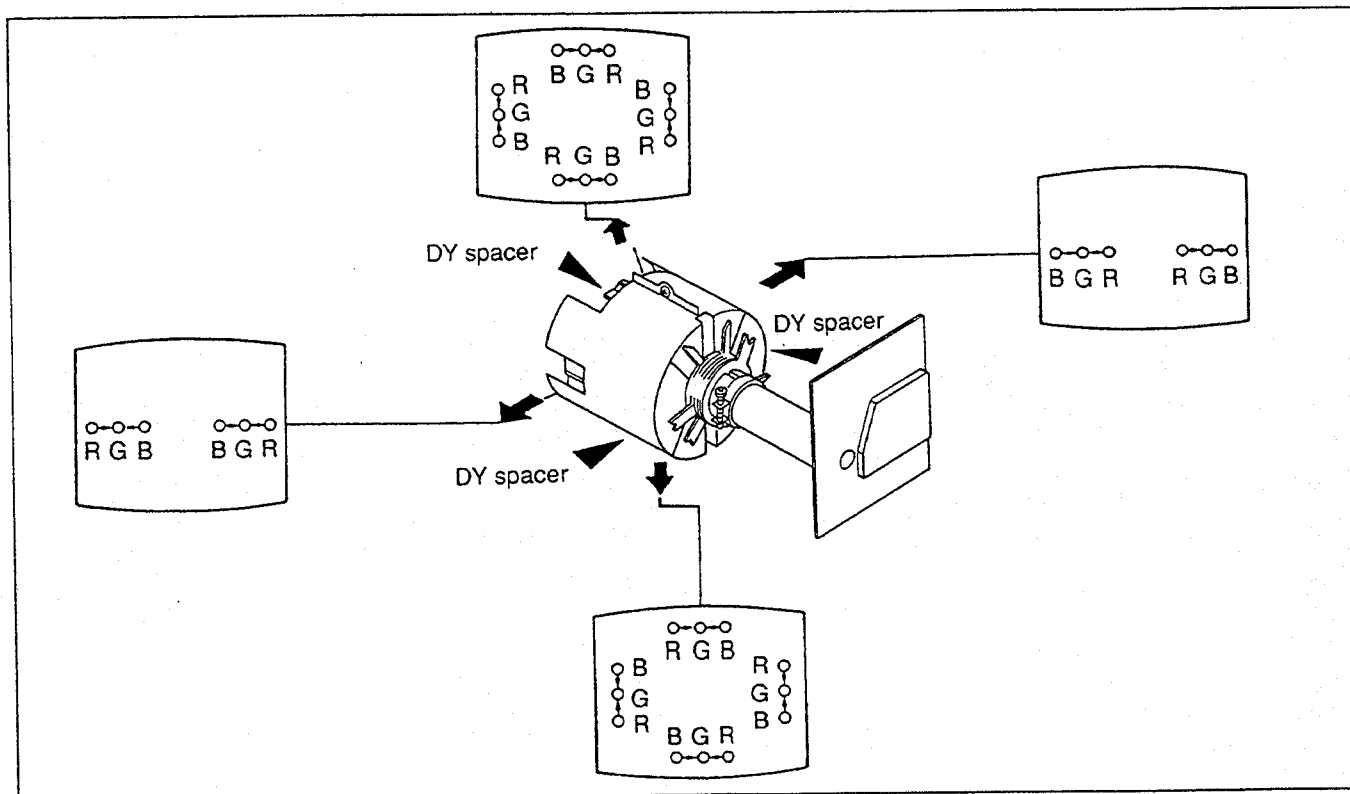

Screen-corner Convergence

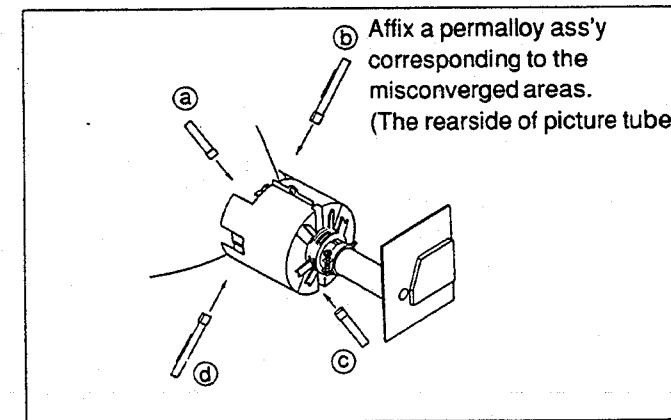
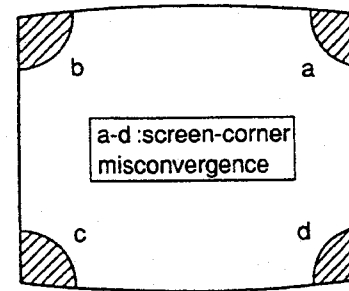

3-3. FOCUS

- Receive a monoscope signal.
- CONTRAST → Normal
- Adjust FOCUS control so that the focus on the center of screen becomes to the best.

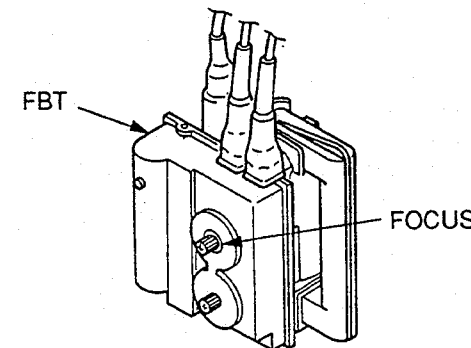

3-4. WHITE BALANCE

[Screen (G2) Voltage Adjustment]

- Receive a dot signal with the pattern generator.
- Adjust R, G, B cut-off controls so that respective cathode voltage against ground becomes 103V DC.
- Observing the screen, adjust SCREEN control so that the background of the dot signal is bright dimly.

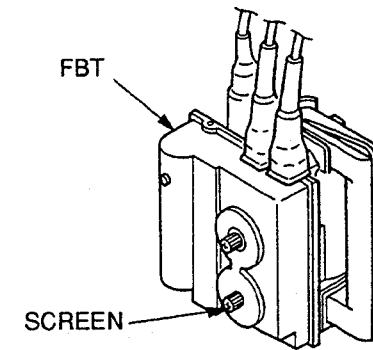

[White Balance]

- Receive a color-bar pattern signal with the pattern generator. (Make black and white screen by chroma switch off.)
- BRIGHTNESS 50%
 - CONTRAST Minimum
 - CHROMA 50%
 - DRIVE control Mechanical center
 - BKG control Mechanical center
- Adjust RV118 (SUB BRT) on B board so that the blue stripe portion on the color-bar pattern signal is bright dimly.

color-bar pattern

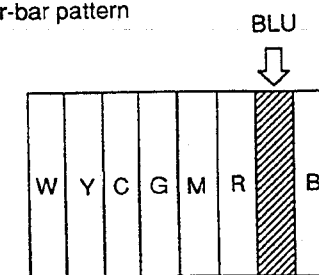

- Receive an entirely white signal from the pattern generator.
- CONTRAST 70% (90 degree clockwise from mechanical center.)
- Using the luminance level meter, adjust the luminance level of the pattern generator becomes 3 Nits. (The condition the screen is bright dimly.)
- Adjust white balance at cut-off using RV119 (G-C/O) and RV121 (B-C/O).
- Change the all-white signal luminance level to 100 IREs.
- Adjust white balance at high-light using RV120 (G-GAIN) and RV121 (B-GAIN).
- Change the unit to blue ONLY mode.
- Adjust white balance (at high-light) in blue ONLY mode using RV124 *R-GAIN/BL and RV125 (G-GAIN/BL).
- Using the luminance level meter, adjust the luminance level of the pattern generator becomes 8 Nits. Confirm that white balance at cut-off is satisfactory..

SECTION 4 SAFETY RELATED ADJUSTMENT

4-1. SAFETY RELATED ADJUSTMENTS

B+ ADJUSTMENT AND B+ MAX CHECK FOR SERVICING (RV651)

The following adjustments should always be performed when replacing the following components (marked with \blacksquare on the schematic diagram).

\blacksquare on G board : (Power supply block)
IC601, IC651, PH601, C654, R653, R655, R656, R657, RV651.

1. Input the AC power supply voltage $240V \pm 1V$.
2. Input the monoscope signal.
3. Set as follows.
 - CONTRAST 80%
 - BRIGHTNESS 50%
4. Connect the digital multimeter to RY1601 pin-⑦ on the D board.
5. Adjust RV651 on the G board so that the +B voltage becomes $40.0 \pm 0.1V$.
6. After adjusting RV651, fix it with an epoxy.
7. Input the AC power supply voltage $240V \pm 1V$.
8. Input the dot signal.
9. Set as follows.
 - CONTRAST Minimum
 - BRIGHTNESS Minimum
10. Check that the B+ voltage is below 41.9V.
If it is above this value, repeat from step 1.

B+ MAX IN DC POWER INPUT MODE, CONFIRMATION (RV1603)

The following adjustments should always be performed when replacing the following components (marked with \blacksquare on the schematic diagram).

\blacksquare on D board :
Q1601, Q1602, Q1603, D1601, D1602, D1603, D1622, C1601, C1602, R1601, R1602, R1603, R1604, R1605, R1606, R1607, R1608, R1628, R1629, R1630, RV1601, RV1603.

1. Supply DC $12V \pm 0.4V$ from DC 12V IN connector.
2. Receive a dot signal.
3.
 - CONTRAST Minimum
 - BRIGHTNESS Minimum
4. Connect a digital multimeter to C1605 positive + side of D board.
5. Turn RV1601 on the D board fully clockwise. Confirm that the voltage of C1605 + pin is less than 41.9V DC.
6. If step 5 is not satisfied, readjust the RV1603. After adjusting, fasten RV1603 in place with epoxy.

HOLD-DOWN CIRCUIT CONFIRMATION (RV833) AND READJUSTMENTS

The following adjustments should always be performed when replacing the following components (marked with \blacksquare on the schematic diagram).

\blacksquare on D board :
IC502, Q833, Q834, Q835, Q836, D835, D836, C519, C843, C844, C845, C846, C847, C848, RV833, R523, R850, R851, R852, R853, R854, R855, R856, R857, R858, R859, R860, R861, R862, R863.
 \blacksquare on P board : C814, NL801, T802 (FBT)

1. Receive an entire white signal.
- CONTRAST Maximum
 - BRIGHTNESS Maximum
3. Connect a digital multimeter to the TP85 (CN503 pin-⑥).
4. Confirm the voltage is $14.1 \pm 3.0V$ DC.
5. Receive a dot signal.
6. Connect an ammeter between D board CN503 pin-⑧ and P board CN801 pin-⑧.
7. Adjust BRIGHTNESS and CONTRAST so that the current is $IABL = 160 \pm 30 \mu A$.
8. Apply an external DC voltage gradually to TP85. When the voltage becomes $18.5V \pm 0.1V$ DC, confirm the HOLD-DOWN circuit operates immediately and raster disappears.
9. When external DC voltage at TP85 becomes $17.5V \pm 0.1V$ DC, confirm the HOLD-DOWN circuit doesn't operate.
10. Receive an entire white signal.
11. Adjust with BRIGHTNESS and CONTRAST controls so that the current is $IABL = 520 \pm 30 \mu A$.
12. Apply DC voltage of $17.8V \pm 0.1V$ to TP85. Confirm the HOLD-DOWN circuit operates immediately and raster disappears.
13. With the same set-up as steps 10 and 11, supply $16.8V \pm 0.1V$ DC to TP85. Confirm that the HOLD-DOWN circuit doesn't operate.
14. When above specifications are not satisfied, readjust RV833. After adjusting, fasten RV833 in place with epoxy.

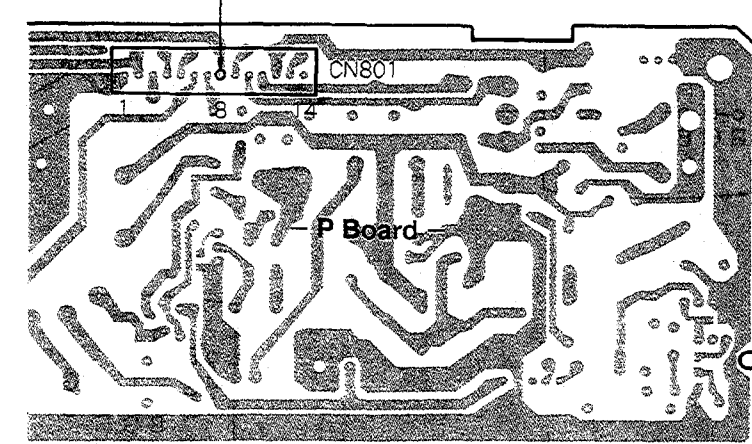
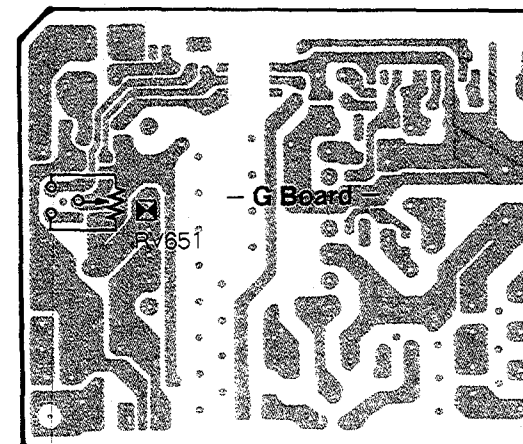
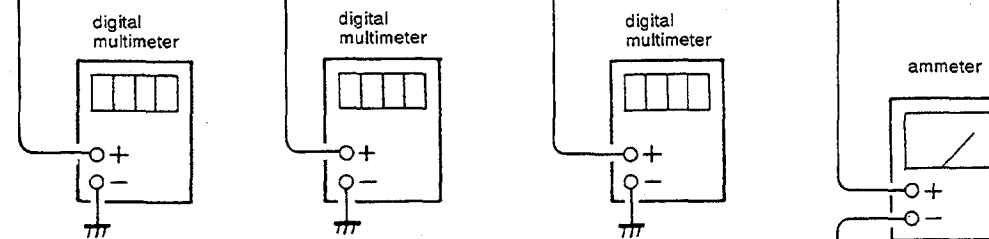
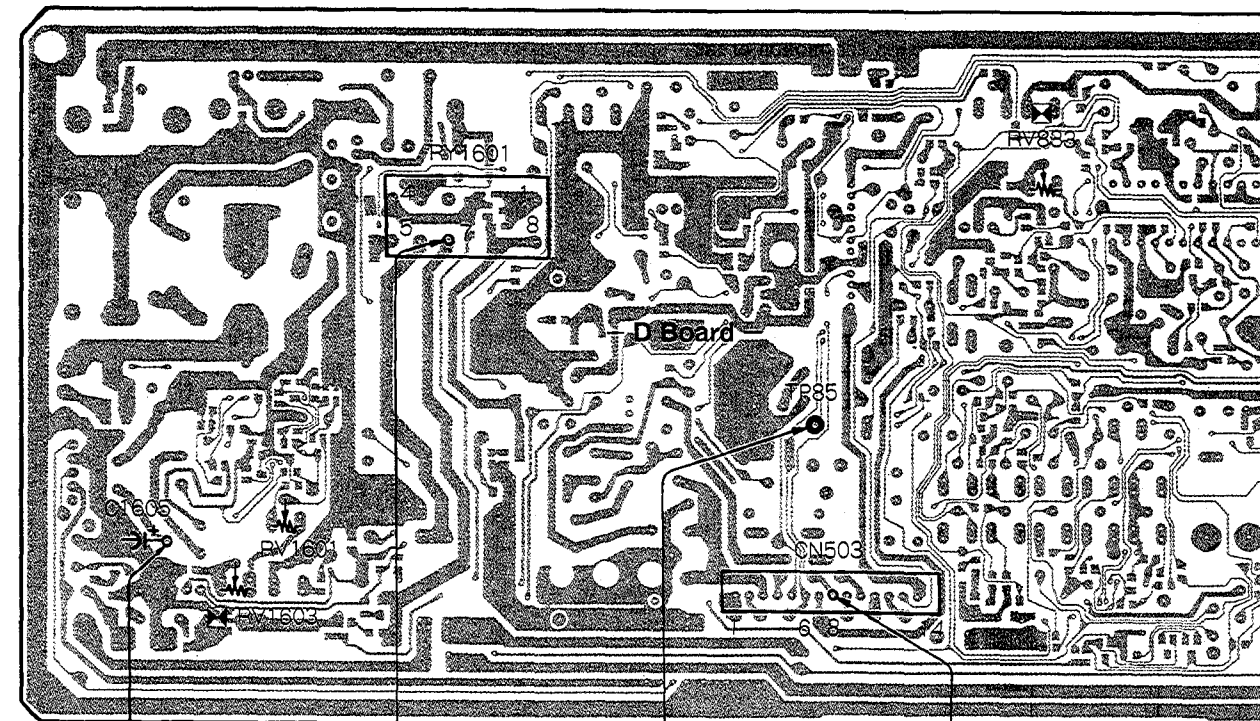

SECTION 5 CIRCUIT ADJUSTMENTS

5-1. D BOARD ADJUSTMENTS

—D BOARD (COMPONENT SIDE)—

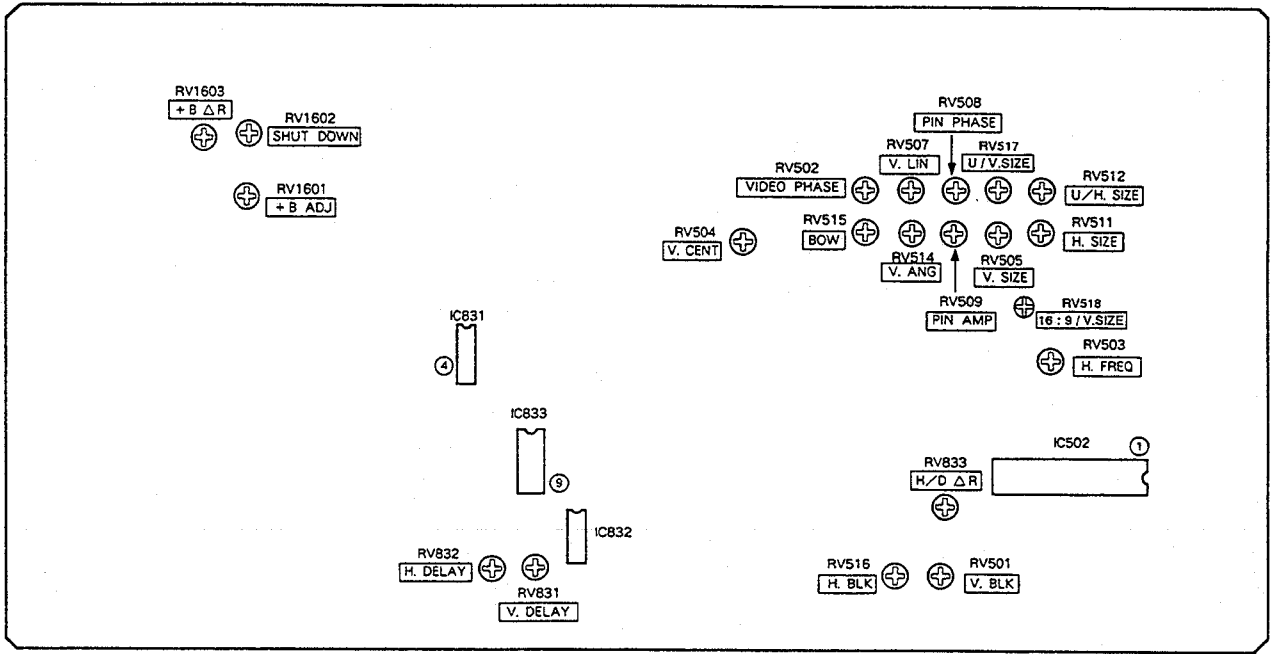

HORIZONTAL OSCILLATION FREQUENCY ADJUSTMENT (RV503)

1. Receive a monoscope signal.
2. Connect pin-① of IC502 to ground with 100μF/16V electrolytic capacitor.
3. Adjust RV503 (H.FREQ) so that the screen streaming to stops.

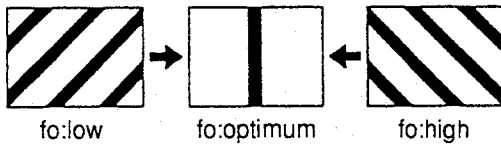

SCREEN PHASE ADJUSTMENTS (RV502, RV512, RV516)

1. Receive a monoscope signal.
2. Set U/S (Under Scan) switch to Under mode.
Set U/S 4:3/16:9 SW to 4:3 mode.
3.
 - CONTRAST Minimum
 - BRIGHTNESS Maximum.
4. Adjust RV512 (U/H. SIZE) so that the white frame of monoscope signal becomes visible.
5. Adjust RV516 (H.BLK) for minimum BLKG width so that all the deflection area becomes visible.
6. Adjust RV502 (VIDEO PHASE) so that the monoscope's white frames should have equal width.

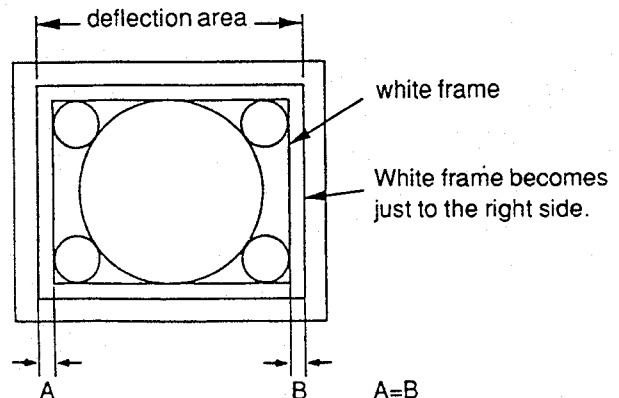

H.V BLK ADJUSTMENTS (RV501,RV516)

1. Receive a monoscope signal.
2. Set U/S (Under Scan) switch to Under mode.
Set U/S 4:3/16:9 SW to 4:3 mode.
3.
 - CONTRAST Minimum
 - BRIGHTNESS Maximum.
4. V. BLK Adjustment (RV501)
 - (1) Adjust RV501(V. BLK) so that the upper side white frame of monoscope signal is not blanked.

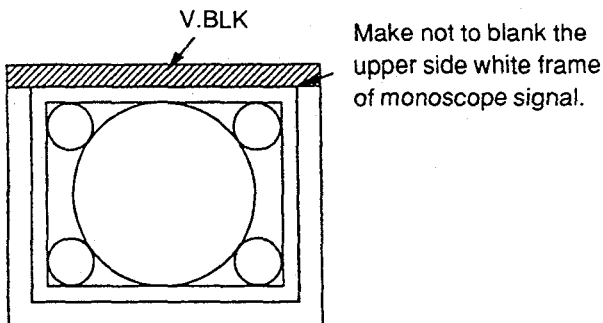

5. H. BLK Adjustment (RV516)
 - (1) Adjust with RV516(H. BLK) so that the left end white vertical line of the white frame of monoscope signal is not blanked as following figure.

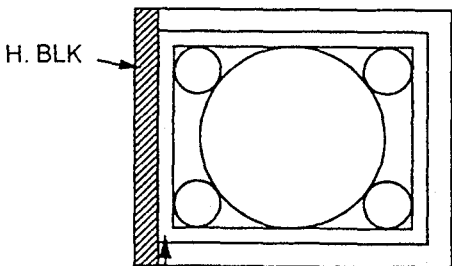

Make not to blank the left end white vertical line of the white frame of monoscope signal.

VERTICAL DEFLECTION PART ADJUSTMENTS (RV504, RV505, RV507, RV517, RV518)

1. Receive a monoscope signal.
2.
 - CONTRAST 70%
 - BRIGHTNESS 50%
3. Adjust RV505 (V. SIZE) so that the vertical size of monoscope signal becomes 12 frames.

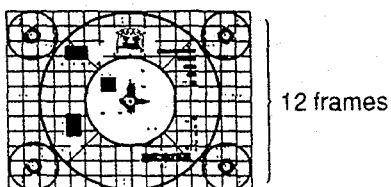

4. Adjust RV507(V.LIN) the vertical linearity.

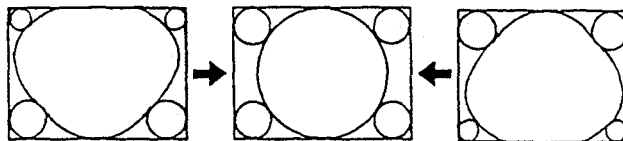

5. Adjust RV504 (V. CENT) the vertical position.

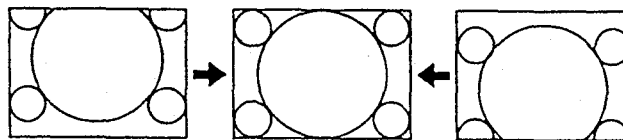

6. 16:9/V.SIZE ADJUSTMENT (RV518)

- (1) Set U/S (Under Scan) switch to Under mode.
- (2) Set 16:9/4:3 switch to 16:9 mode.
- (3) Adjust the 16:9/V.SIZE with RV518 (16:9/V.SIZE) as follows.

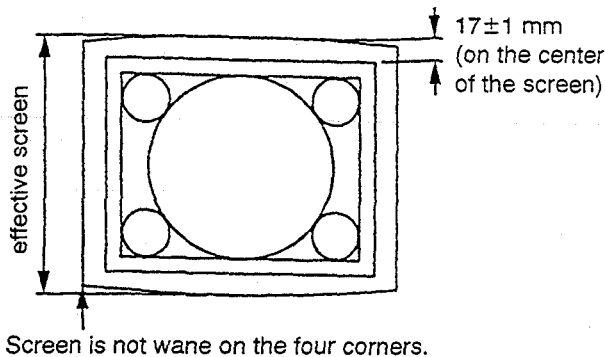

HORIZONTAL DEFLECTION PART ADJUSTMENTS (RV508, RV509, RV511, RV514, RV515, RV801/P board)

1. Receive a monoscope signal.
2.
 - CONTRAST 70%
 - BRIGHTNESS 50%
3. H. CENT Adjustment (RV801 on P board)
 - (1) Adjust RV801 on P board (H. CENT) the horizontal position.

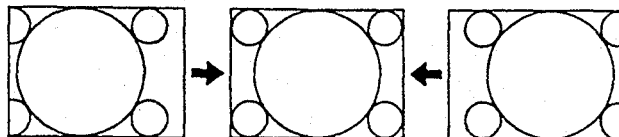

4. H. SIZE Adjustment (RV511)

- (1) Adjust RV511 (H. SIZE) the horizontal size of 16 frames of monoscope signal.

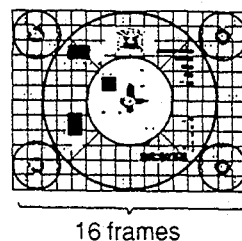

5. PIN AMP, PIN PHASE, V. ANG, BOW ADJUSTMENTS (RV508 RV509, RV514, RV515)

Adjust RV514 (V. ANG) and RV515 (BOW) to correct vertical angular distortion and bow distortion. Adjust RV509 (PIN AMP) and RV508 (PIN PHASE) so that vertical lines become straight.

- V. ANG (RV514)

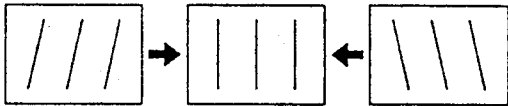

- BOW (RV515)

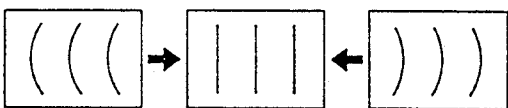

- PIN AMP (RV509)

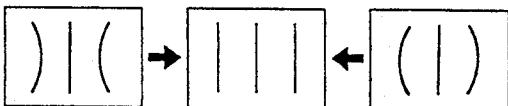

- PIN PHASE (RV508)

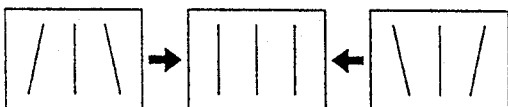

6. H. SIZE ADJUSTMENT (RV511)

- (1) Adjust RV511 (H. SIZE) so that the horizontal size becomes 16 ± 0.2 frames.

7. UNDERSCAN MODE H.SIZE ADJUSTMENT (RV512)

- (1) Set U/S (Under Scan) switch to Under mode.
- (2) Adjust RV512 (U/H. SIZE) the Under H. SIZE as shown in the figure.

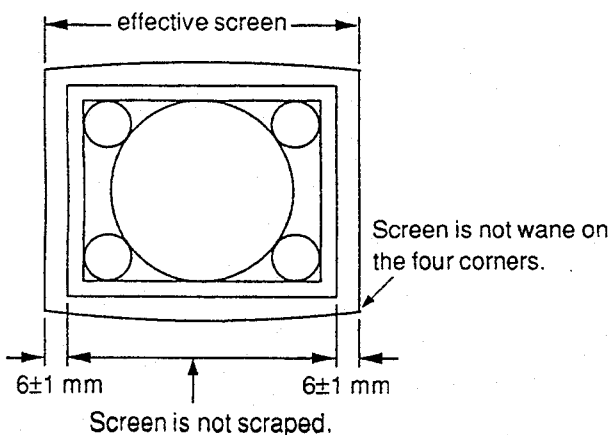

H V DELAY ADJUSTMENT (RV831, RV832)

1. Receive a monoscope signal.
2. • CONTRAST 70%
• BRIGHTNESS 50%
3. Set H V DELAY switch to DELAY mode.
4. H. DELAY Adjustment (RV832)
 - (1) Connect an oscilloscope to pin-④ of IC831.
 - (2) Adjust RV832 (H. DELAY) to becomes $41 \pm 1 \mu\text{sec}$.

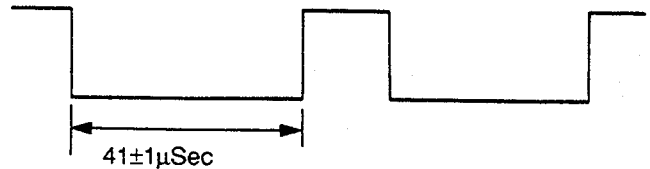

5. V. DELAY Adjustment (RV831)

- (1) Connect an oscilloscope to pin-⑤ of IC833.
- (2) Adjust RV831 to become $8.0 \pm 0.4 \text{mSec}$ as follows.

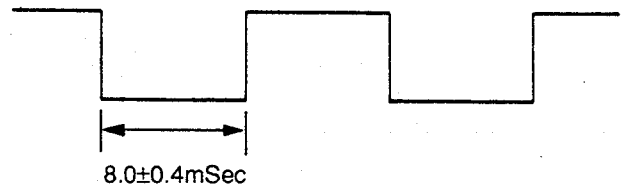

SHUT-DOWN VOLTAGE ADJUSTMENT (RV1602)

1. Fully rotate RV1602 in the direction that does not shut-down.
2. Supply a $9.4\text{V} \pm 0.1\text{V}$ voltage to the C1602 side of L1602 on the D board.
3. Turn AC power switch ON.
4. Rotate D board RV1602 (SHT DOWN) slowly to the point that shuts-down the unit.

B+ VOLTAGE DURING DC OPERATE MODE, ADJUSTMENT (RV1601)

1. Supply $DC12\text{V} \pm 0.2\text{V}$ to DC 12V IN connector.
2. Receive a monoscope signal.
3. • CONTRAST 80%
• BRIGHTNESS 50%
4. Connect a digital voltmeter to C1605 + positive side on D board.
5. Adjust RV1601 on the D board for $40.0 \pm 0.1\text{V DC}$.

5-2. B BOARD ADJUSTMENT

-B BOARD (COMPONENT SIDE)-

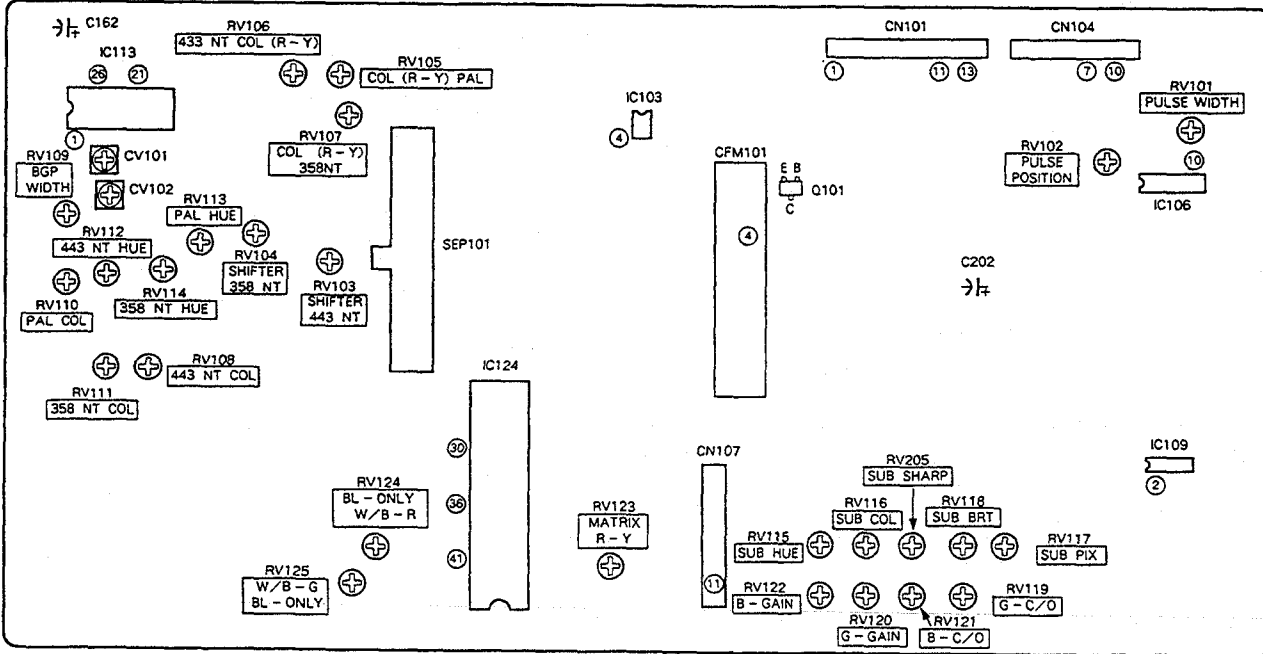

-B BOARD (CONDUCTOR SIDE)-

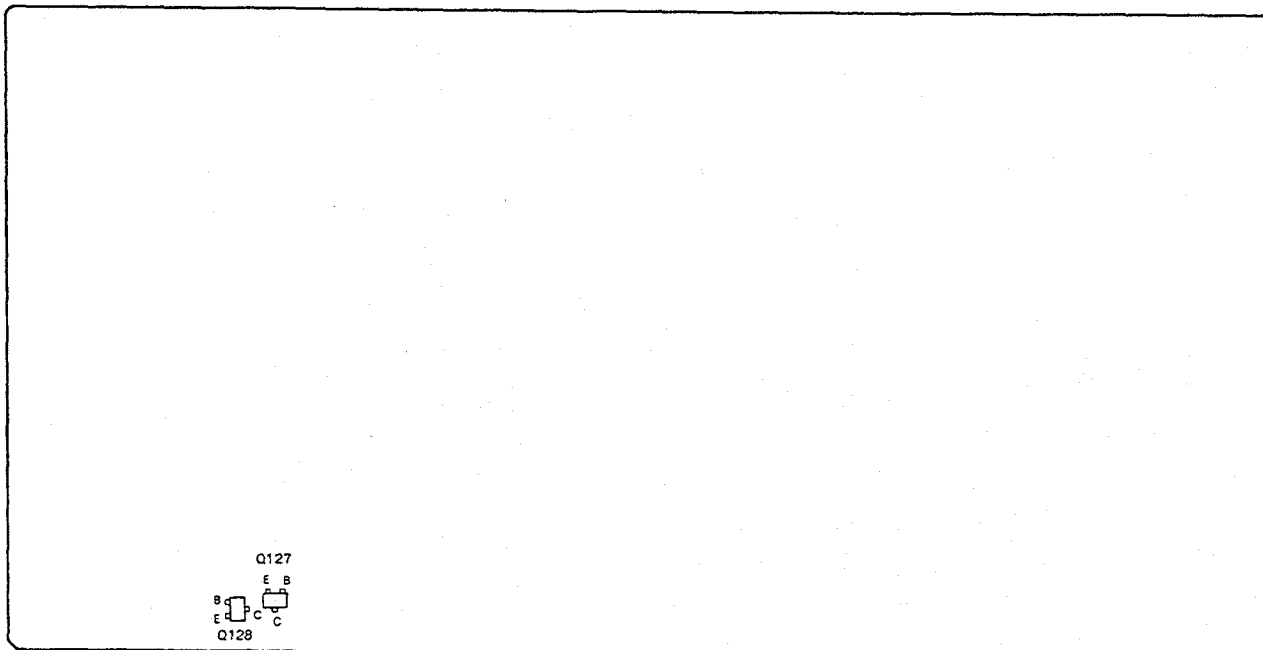

**PRIMARY COLOR MATRIX ADJUSTMENT
(RV115, RV116, RV123)**

1. Supply component color bar signal (75% chroma color bar) to the equipment so that Y signal is supplied to EXT SYNC and R-Y signal to R-Y connectors. Operate the equipment in external sync mode.
2. Connect oscilloscope to IC124 pin-30 (B-OUT).
3. Adjust RV115 (SUB HUE) to obtain the Blue output as shown in figure.

(B-OUT)

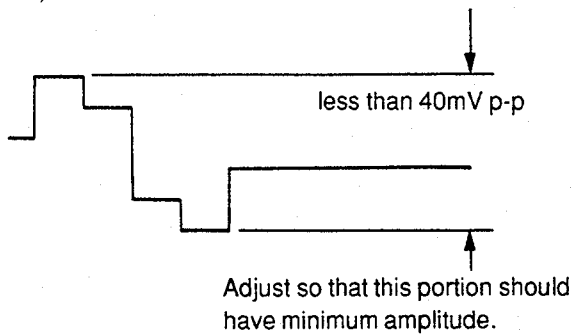

4. Supply component color bar signal (75% color bar) to the component input connector to feed R-Y and B-Y signals. Operate the equipment in internal SYNC mode.
5. Connect oscilloscope to IC124 pin-30 (SUB-COL). Adjust RV116 (SUB-COL) so that waveform peaks should have the same level.

(B-OUT)

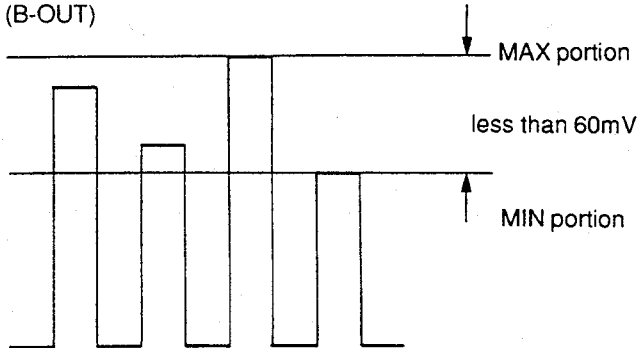

6. Connect oscilloscope to IC124 pin-41 (R-OUT).
7. Adjust RV123 ((R-Y)-IN) so that waveform peaks should have the same level.

(R-OUT)

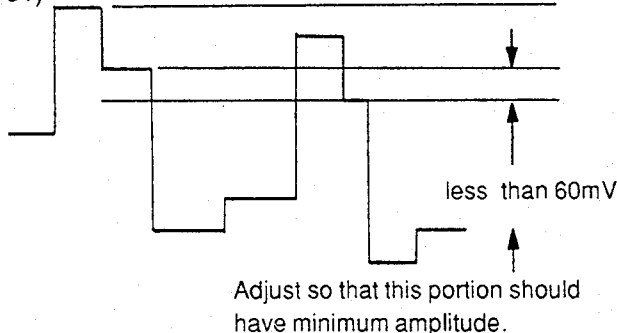

BURST GATE PULSE WIDTH ADJUSTMENT (RV109)

1. Receive color bar signal.
2. Connect dual trace oscilloscope to CN104 connector pin-10 (COMP-SYNC) and IC113 (M51279) pin-1 (BGP-WIDTH). Adjust RV109 (BGP-WIDTH) to obtain the relationship as shown in the figure.

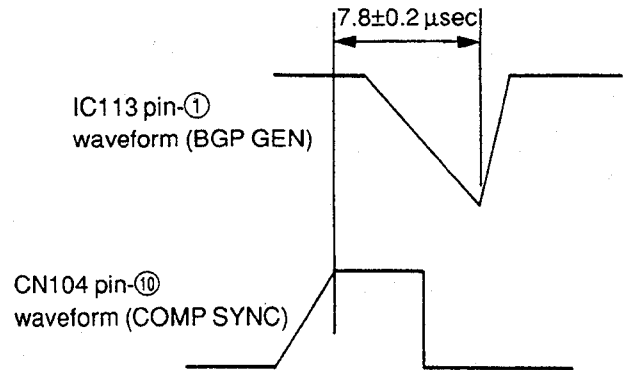

VXO ADJUSTMENT (CV101, CV102)

1. 3.58MHz VXO adjustment (CV101)
 - (1) Receive NTSC color bar signal.
 - (2) Connect +5V power line to IC113 pin-26 (ID-FILT-REF) via a 4700Ω resistor.
 - (3) Ground IC109 pin-2 by connecting it to ground.
 - (4) Ground C162 - negative side by connecting it to ground.
 - (5) Connect frequency counter to IC113 pin-21. Adjust CV101 (358FO) for 3579545±20Hz. (This adjustment can be alternatively done by observing screen as below.)

Adjust color synchronization by CV101 (358FO).

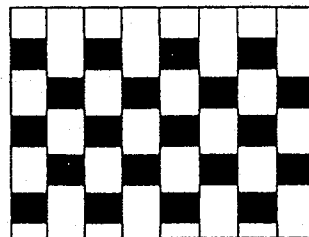

Adjust so that color stripes disappear and the hue change is stabilized extremely.

PVM-9041QM/9044QM

2. 4.43MHz VXO adjustment (CV102)

- (1) Receive PAL colour bar signal.
- (2) Connect +12V power line to IC109 pin-②.
- (3) Connect frequency counter to IC113 pin-②. Adjust CV102 (443FO) for $4433619 \pm 20\text{Hz}$.
(This adjustment can be alternatively done by observing screen as below.)

Adjust colour synchronization by CV102(443FO).

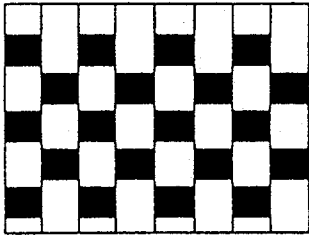

Adjust so that colour stripes disappear and the hue change is stabilized extremely.

NTSC COMB FILTER ADJUSTMENT (RV1,T1/CFM101 BOARD)

1. Receive NTSC 3.58 color bar signal.
2. Connect an oscilloscope to C202 – negative side.
3. Confirm the Y OUT is $0.78 \pm 0.5 \text{ Vp-p}$.
4. Confirm the residual chroma is 32 mVp-p below. If it is above 35 mVp-p, adjust with RV1 and T1 on CFM101 board while tracking

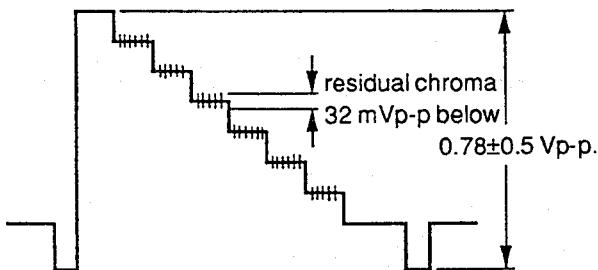

NTSC COLOR DEMODULATION ADJUSTMENT (RV114,RV111,RV104,RV107)

1. NTSC 3.58MHz - HUE adjustment (RV114)
 - (1) Supply NTSC color bar signal including burst and R-Y component.
(For example, Tektronix 1410SG output color bar signal with B-Y component removed.)
 - (2) Connect an oscilloscope to Q128 emitter (B-Y OUT).
 - (3) Adjust RV114 (358NT - HUE) so that all the waveform peaks should have equal amplitude (look flat) except burst. (Level difference should be less than 10mV p-p.)

2. NTSC 3.58MHz - COLOR adjustment (RV111)

- (1) Receive NTSC 3.58 color bar signal.
- (2) Connect an oscilloscope to IC124 pin-⑩ (B-OUT).
- (3) Adjust RV111(358NT-COL) so that waveform peaks should have the same level (most flat).

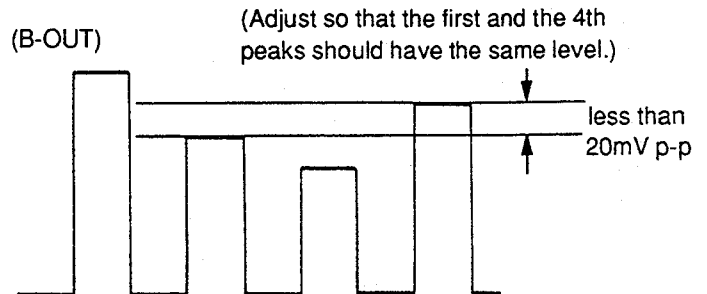

3. NTSC 3.58MHz - COLOR (R-Y) adjustment (RV104, RV107)

- (1) Receive the color bar signal.
- (2) Connect an oscilloscope to the Q127 emitter (R-Y OUT), and adjust RV104 (358NT-SHIFT) so that the output of the burst section (B-Y axis signal output) becomes 0.
- (3) Connect an oscilloscope to IC124 pin-④ (R-OUT). Adjust RV107 (358NT-COL (R-Y)) so that the level difference should be minimum.

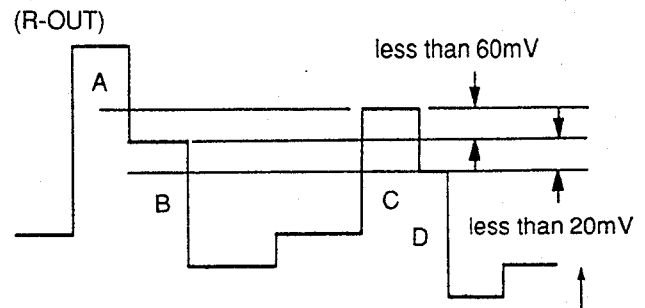

(Adjust for B=D. [less than 20mV] Also level difference between B and C should be less than 60mV.)

NTSC 4.43MHz COLOR DEMODULATION ADJUSTMENT (RV108,RV112,RV103,RV106)

1. NTSC 4.43MHz - COLOR adjustment (RV108,RV112)
 - (1) Receive NTSC 4.43 color bar signal (75% color bar).
 - (2) Connect an oscilloscope to IC124 pin-30 (B-OUT).
 - (3) Adjust RV108 (443NT-COL) so that waveform peaks should have the same level (most flat).

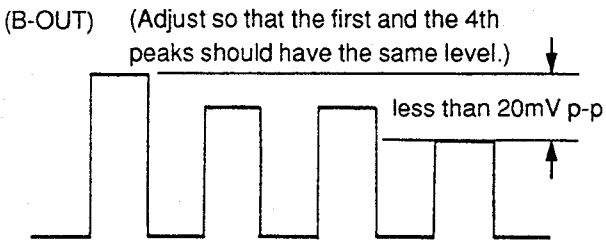

- (4) When cyan and magenta have level difference, adjust RV112 (443NT-HUE) and RV108 (443NT-COL) alternatively to remove, by tracking.

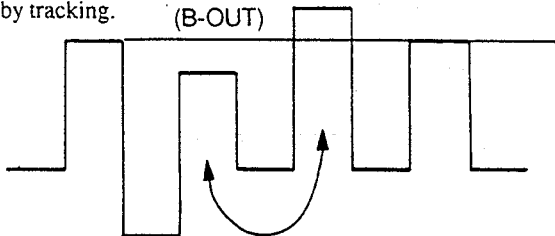

When cyan and magenta have level difference, adjust RV112 and RV108 alternatively to remove.

2. NTSC 4.43MHz - COLOR (R-Y) adjustment (RV103, RV106)
 - (1) Receive the NTSC 4.43 color bar signal (75%, chroma color bar).
 - (2) Connect an oscilloscope to the Q127 emitter (R-Y OUT), and adjust RV103(443NT-SHIFT) so that the output of the burst section (B-Y axis signal output) becomes 0.
 - (3) Connect an oscilloscope to IC124 pin-4 (R-OUT). Adjust RV106 (443NT-COL (R-Y)) so that the level difference should be minimum.

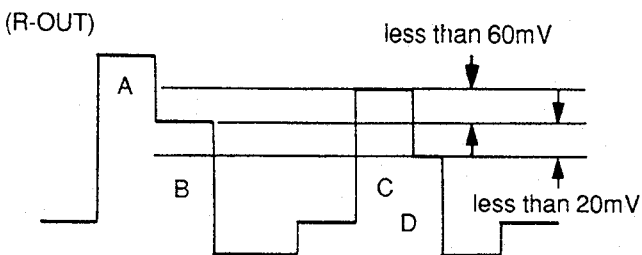

(Adjust for B=D. [less than 20mV] Also level difference between B and C should be less than 60mV.)

PAL COLOR DEMODULATION ADJUSTMENT (RV113, RV2/SEP101, RV110, RV105)

1. PAL PHASE Adjustment (RV113,RV2/SEP101)
 - (1) Receive the special PAL color-bar.
 - (2) Connect an oscilloscope to emitter of Q127 (R-Y OUT).
 - (3) Adjust RV113 (PAL-PHASE) so that B-Y (0/180°) anti-PAL portion (in the R-Y demodulated output) becomes "0" (flat) as following figure.

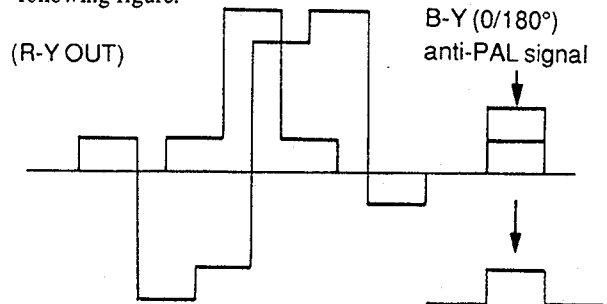

* The anti-PAL portion has a small level difference in every other horizontal period. So, adjust so that average becomes "0".

- (4) Connect an oscilloscope to emitter of Q128 (B-Y OUT).
- (5) Adjust RV2 inside SEP101 so that R-Y (90°/90°) anti-PAL portion (in B-Y demodulated output) becomes "0" (flat) as following figure.

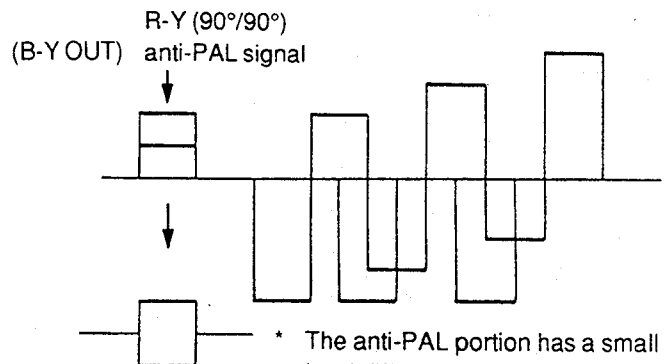

* The anti-PAL portion has a small level difference in every other horizontal period. So, adjust so that average becomes "0".

(For the adjustments of (3) and (5), it is also possible to set the color level to MAX with the chroma adjusting knob of the unit and erase the color of the anti-pal signal section.)

2. PAL COLOR ADJUSTMENT (RV110)

- (1) Receive PAL color bar signal (75% color bar).
- (2) Connect an oscilloscope to IC124 pin-30 (B-OUT).
- (3) Adjust RV110 (PAL-COL) so that waveform peaks should have the same level (most flat).

(B-OUT) (Adjust so that the first and the 4th peaks should have the same level.)

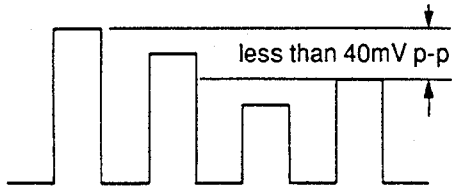

3. PAL-COLOR-(R-Y) ADJUSTMENT (RV105)

- (1) Connect an oscilloscope to IC124 pin-41 (R-OUT).
- (2) Adjust RV105 (PAL-COL-(R-Y)) so that waveform peaks should have the same level (most flat).

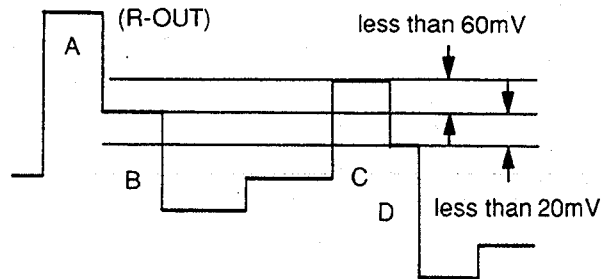

(Adjust for B=D. [less than 20mV] Also level difference between B and C should be less than 60mV.)

CHROMA H PULSE POSITION ADJUSTMENT (RV101, RV102)

- (1) Receive the SECAM color bar signal.
(The left edge of the screen should not be colored.)
- (2) Set to the under-scan mode.
- (3) Adjust RV101 (PLUSE-WIDTH) until the point immediately before the color on the left edge of the screen disappears.
- (4) Release the under-scan mode.
- (5) Set the HV DELAY mode.
- (6) Adjust RV102 (PULSE-POSI) until the point immediately before the rising color of the image after back porch disappears.

Note : If image phase adjustment or HV DELAY amount adjustment during HV DELAY is performed after completing the adjustment in this section, re-adjustments will be required. Therefore, performed this adjustment after the two mentioned have been performed.

SUB-SHARP ADJUSTMENT (RV205)

- (1) Receive a sweep signal (or multi-burst).
- *
 - Bandwidth should be more than 10MHz (flat).
 - Composite sync should be included.
 - Turn burst off.
- (2) Connect an oscilloscope to IC124 pin-36 (G-OUT).
- (3) Adjust RV205 (SUB-SHARP) as shown.

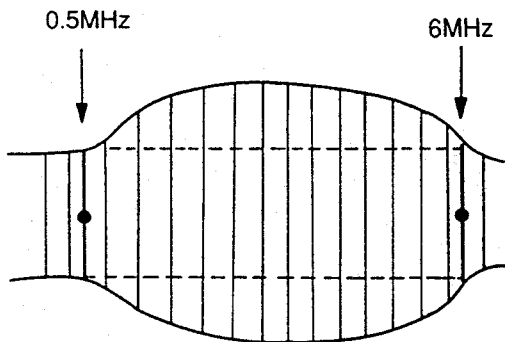

Example of sweep signal output waveform

[specification]
6MHz/0.5MHz=0±0.5dB

Suppl 3

5-3. S BOARD ADJUSTMENTS

—S BOARD (COMPONENT SIDE)—

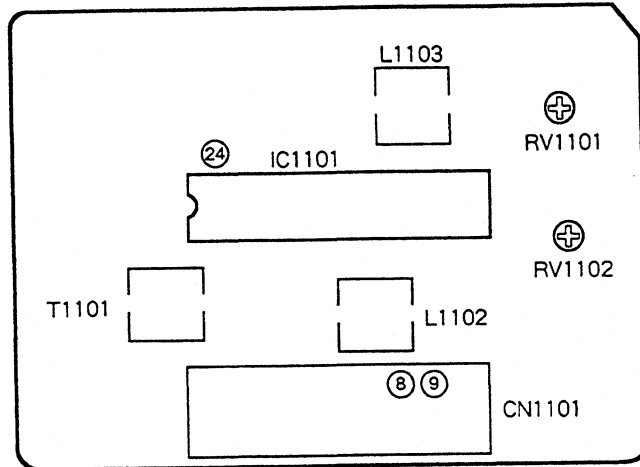

SECAM (T1101, L1102, L1103)

1. Receive SECAM color-bar.
2. Bell Filter Adjustment (T1101)
 - (1) Connect an oscilloscope to IC1101 pin-24.
 - (2) Adjust T1101 (Bell Filter) so that the chroma waveform becomes smooth. (Uneven level should be minimum.)

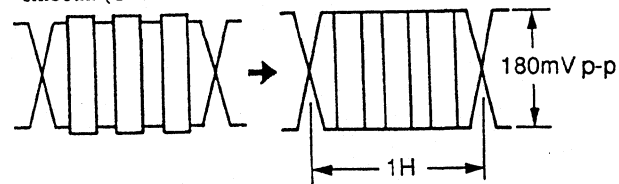

3. Color Balance Adjustment (L1102, L1103)
 - (1) Connect an oscilloscope to pin-9 (R-Y) of CN1101 connector.
 - (2) Adjust L1102 (R-Y) so that the non-colored portion level becomes flat.

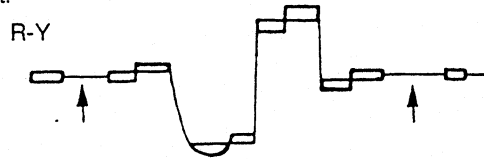

- (3) Connect an oscilloscope to pin-8 (B-Y) of CN1101 connector.
 - (4) Adjust L1103 (B-Y) so that the non-colored portion level becomes flat.

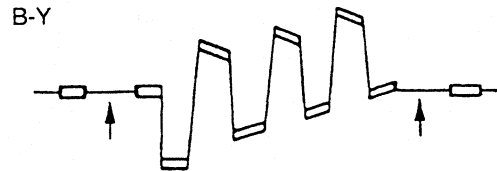

- (5) When adjusting the color level of the unit to MAX or MIN using the chroma adjusting knob, check that the white balance of the colorless section does not change.

DEMODULATION LEVEL ADJUSTMENT (RV1101, RV1102)

1. Receive SECAM color-bar.
2. Connect an oscilloscope to IC124 pin-30 (B-OUT).
3. Adjust S board RV1101 (SEC-COL) so that waveform peaks should have the same level (most flat).

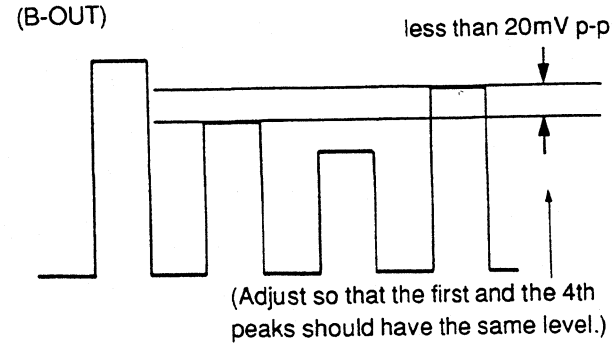

4. Connect an oscilloscope to IC124 pin-41 (R-OUT).
5. Adjust S board RV1102 (SEC-COL (R-Y)) so that the level difference should be minimum.

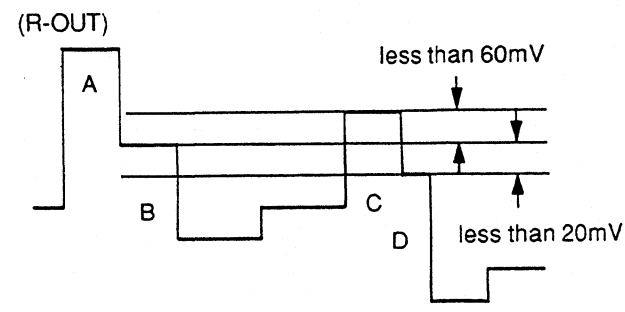

(Adjust for B=D. [less than 20mV] Also level difference between B and C should be less than 60mV.)

6-1. BLOCK DIAGRAMS (1)

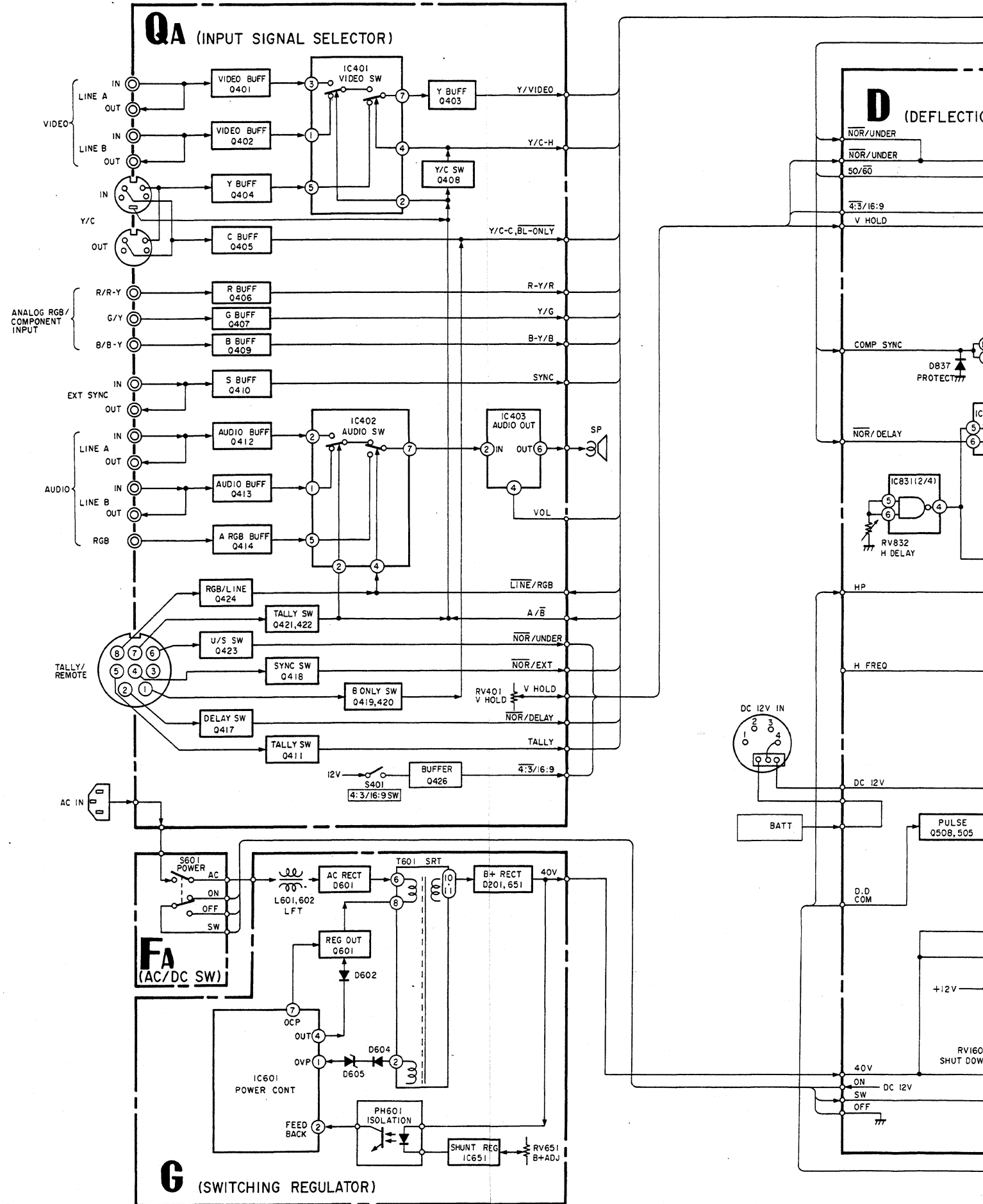

Suppl 3

SECTION 6
DIAGRAMS

9044QM

MS (1)

(INPUT SIGNAL SELECTOR)

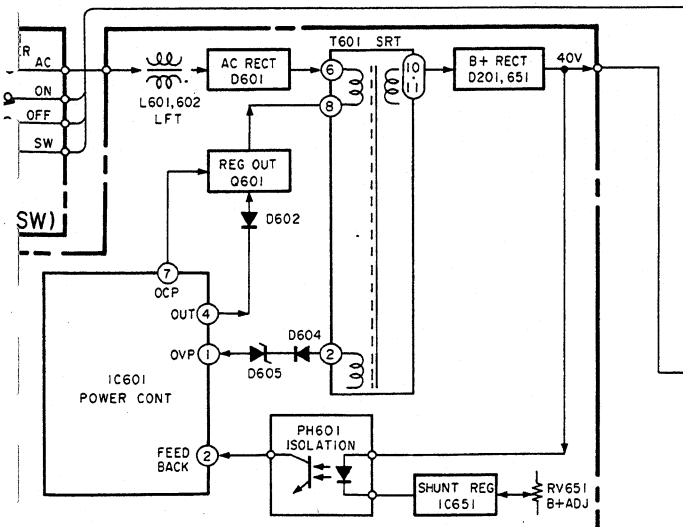
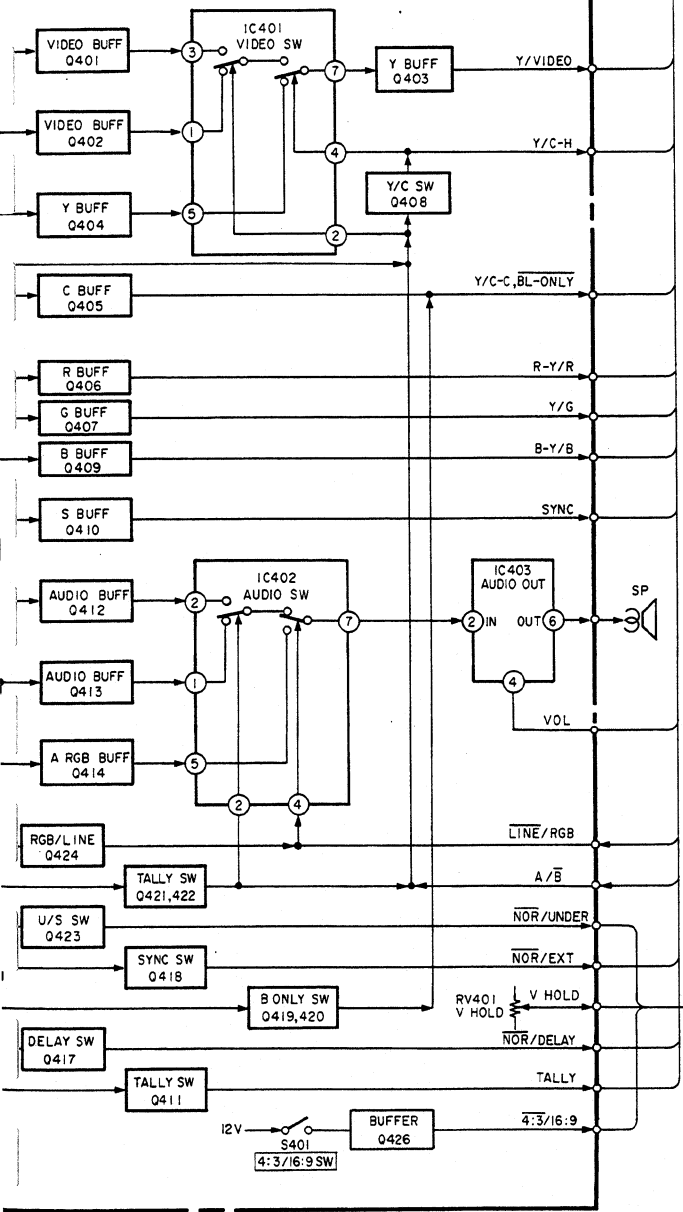

(SWITCHING REGULATOR)

D (DEFLECTION SYSTEM)

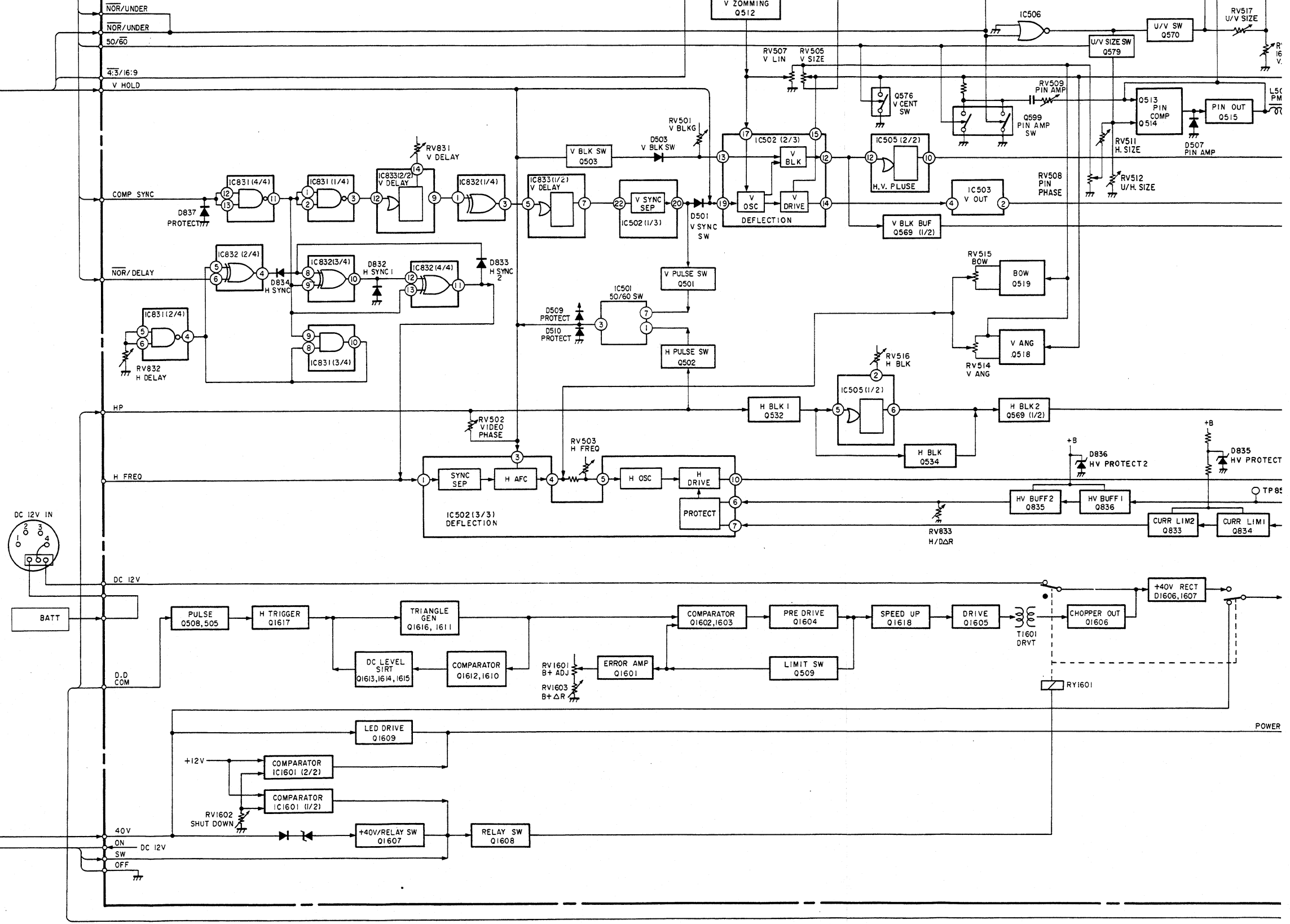

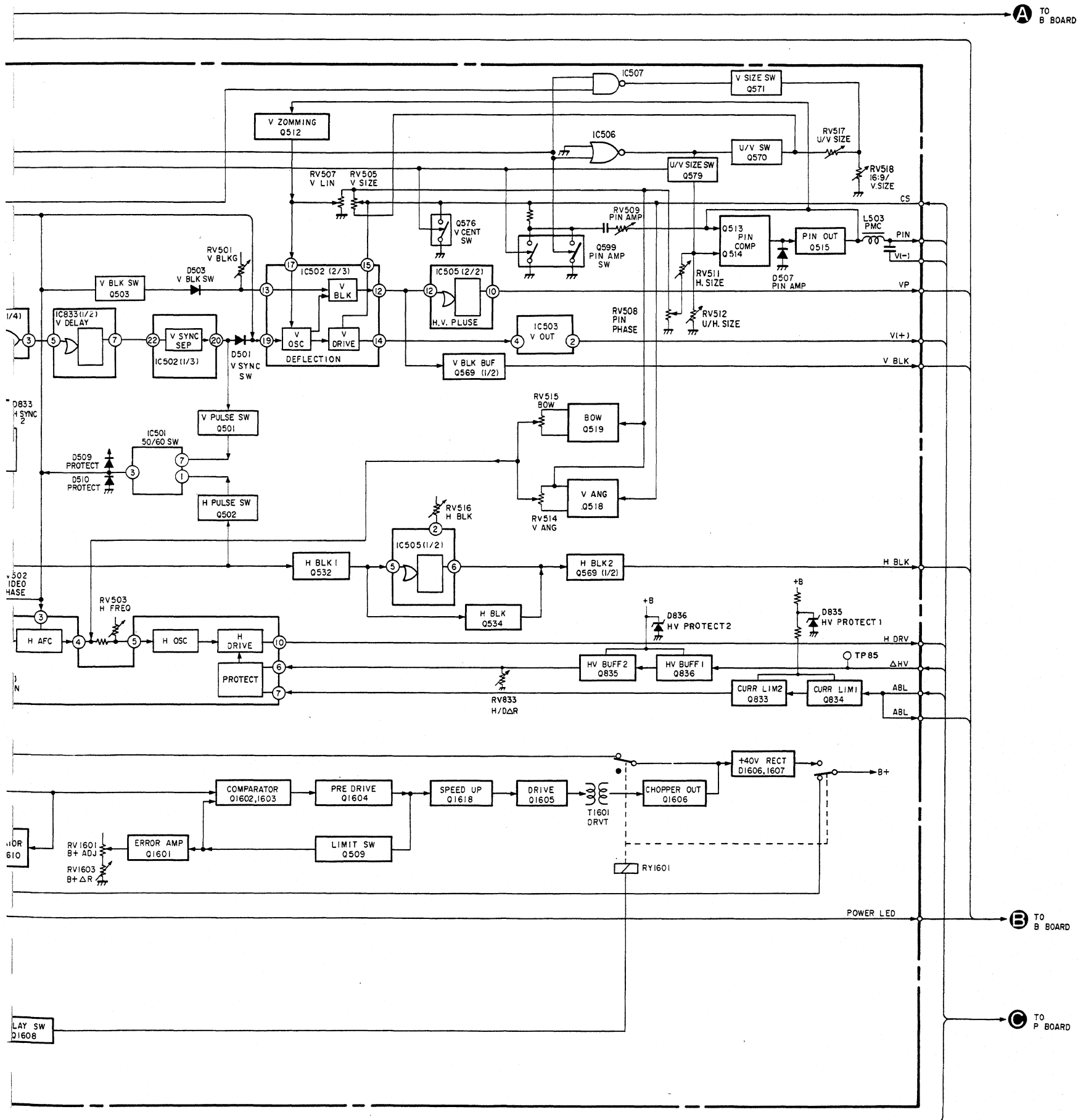

BLOCK DIAGRAMS (2)

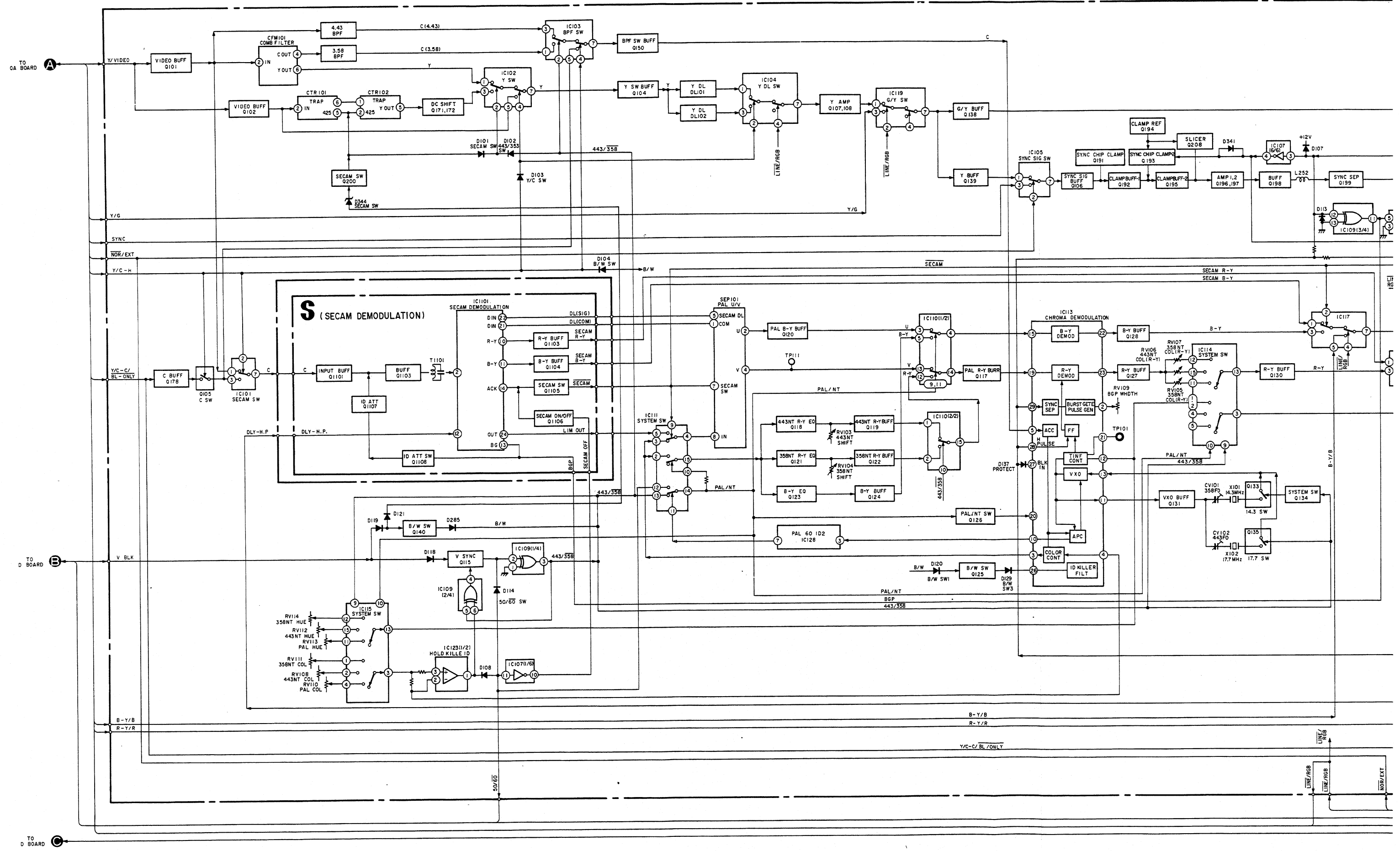

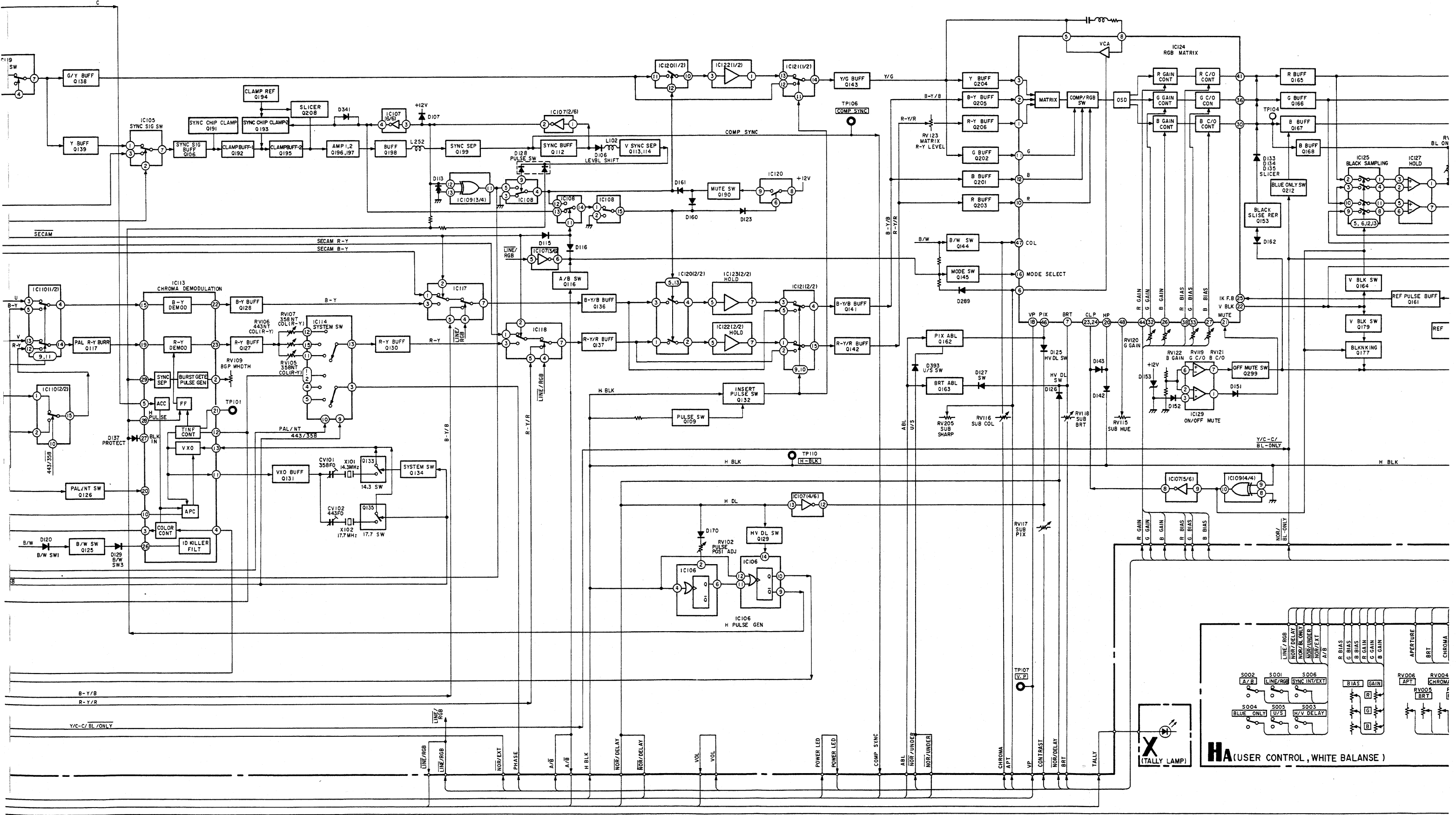

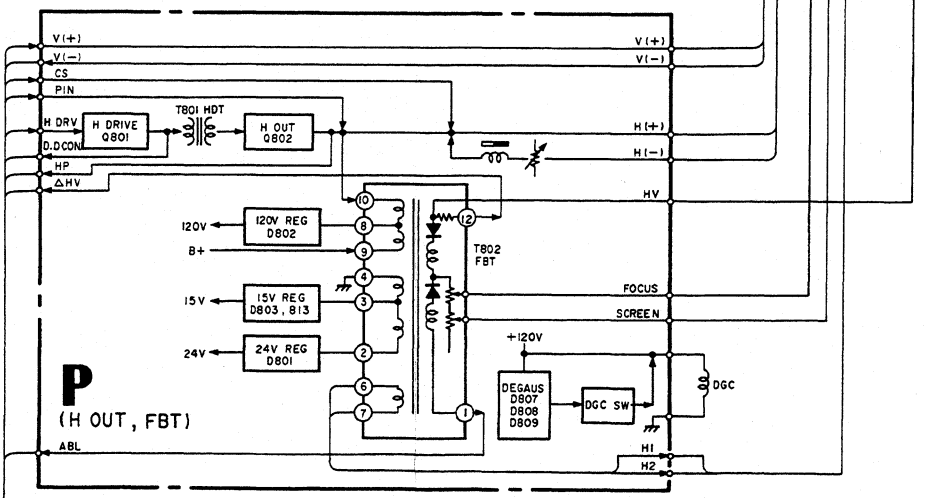
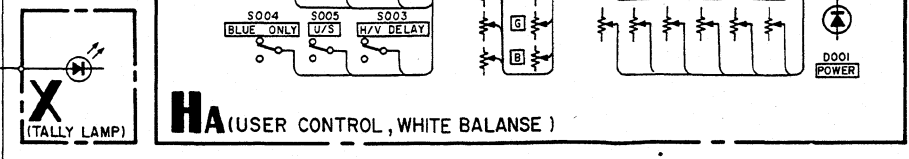
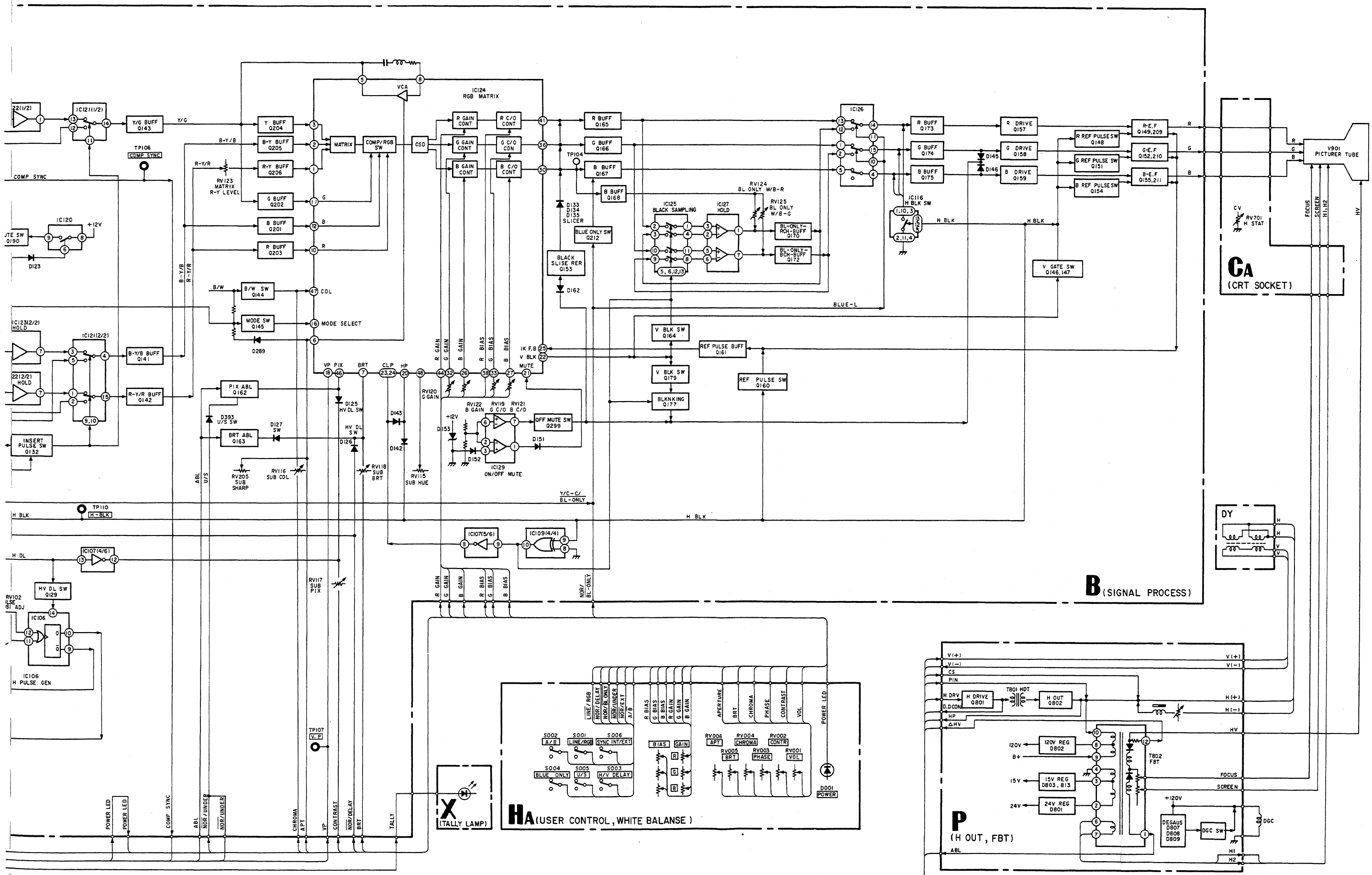

6-2. FRAME SCHEMATIC DIAGRAM

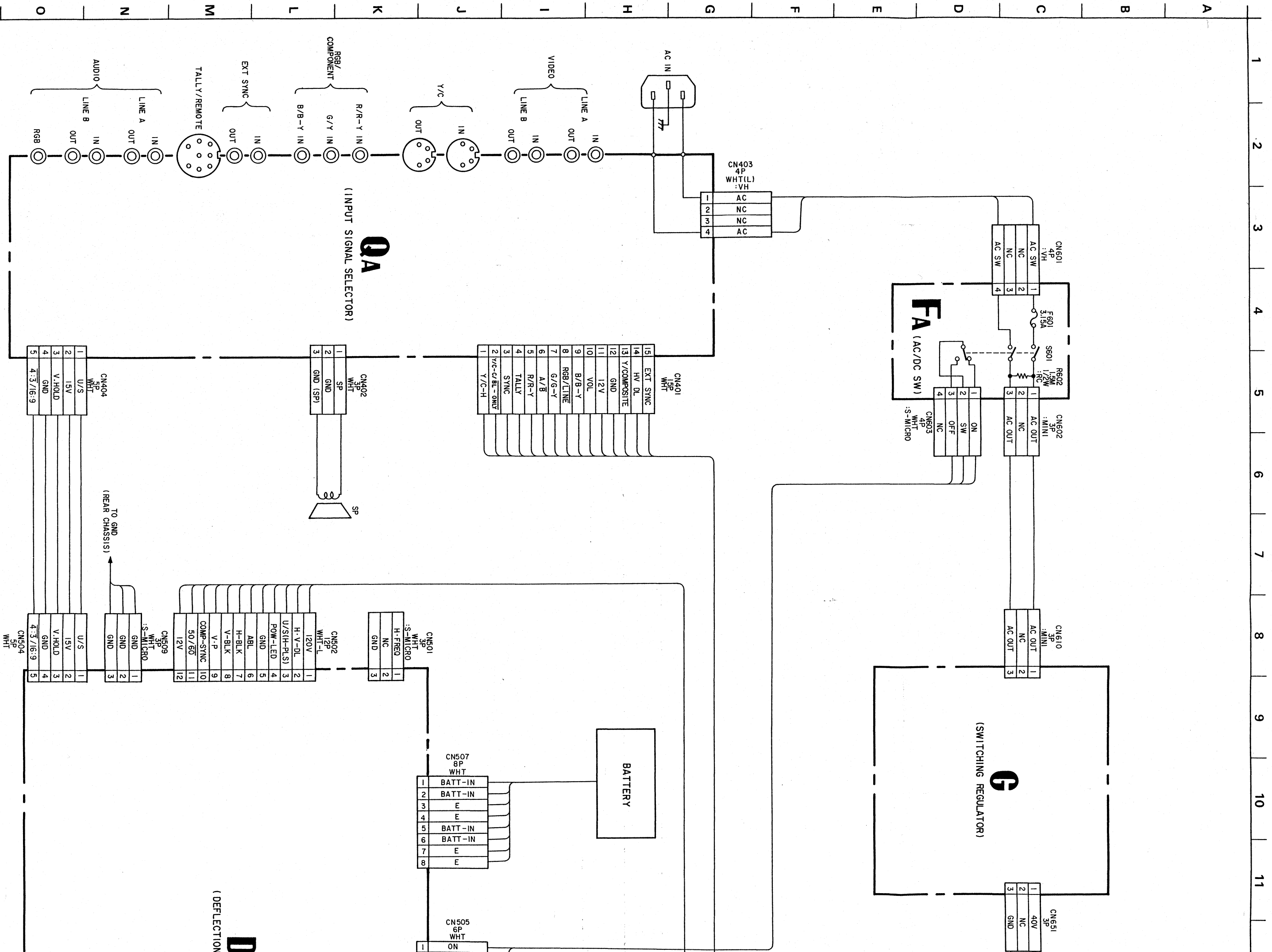

TO GND
(REAR CHASSIS)

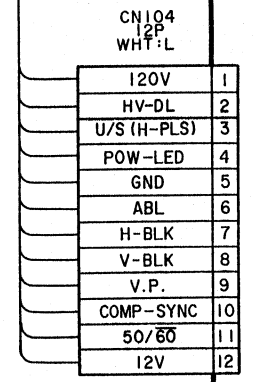
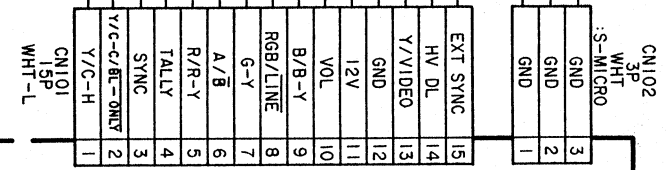
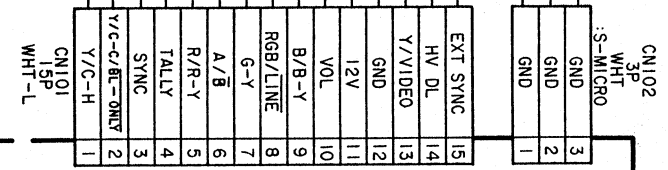
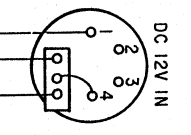
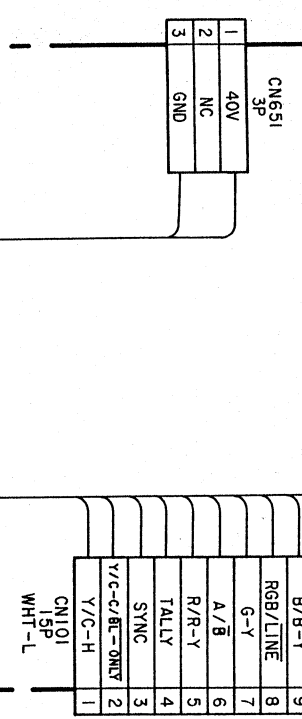

B
(SIGNAL PROCESS)

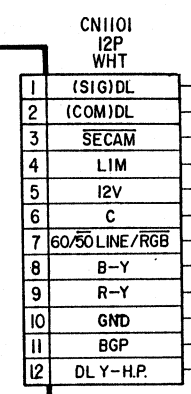
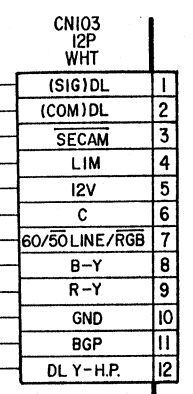

S
(SECAM DEMODULATION)

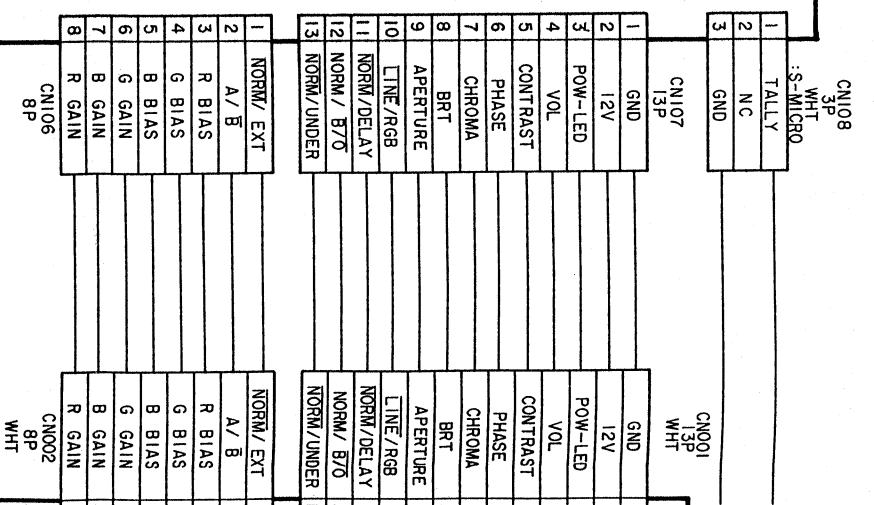
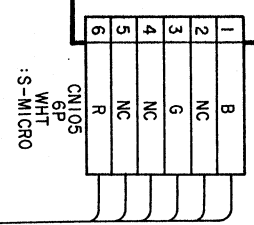
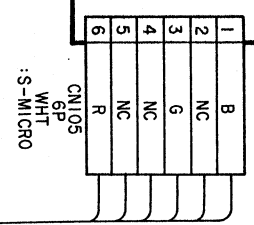
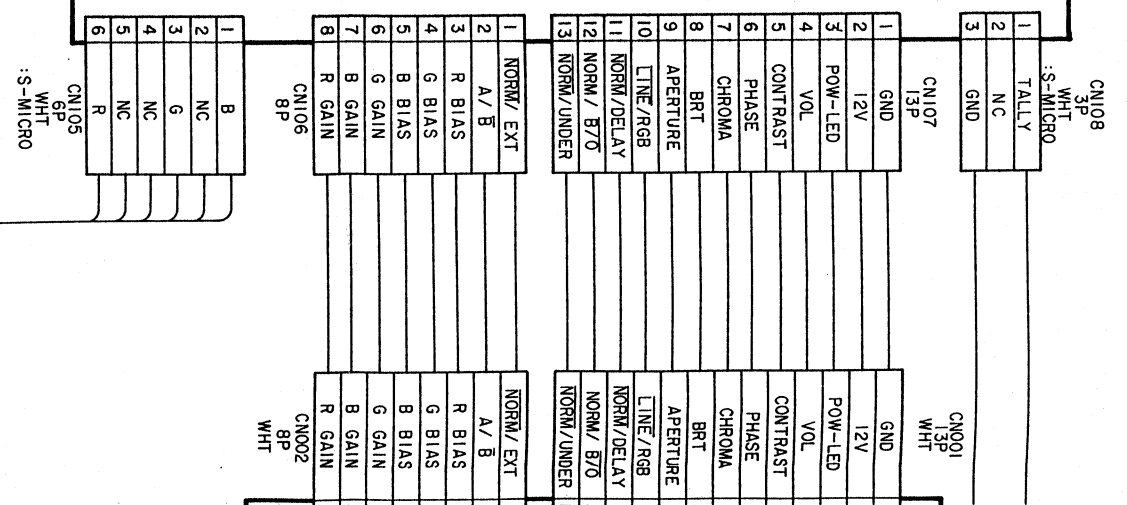

P
(H OUT, FBT)

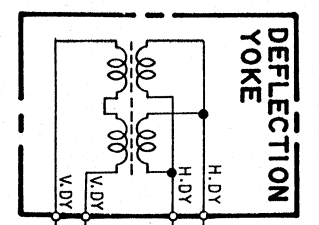
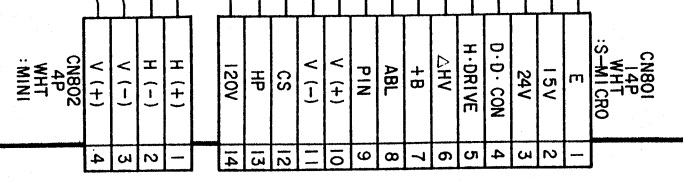
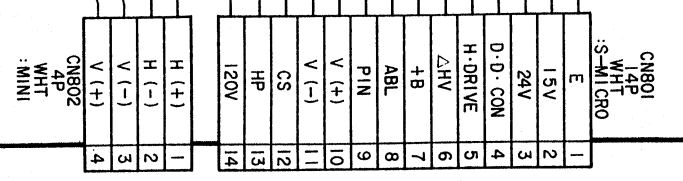
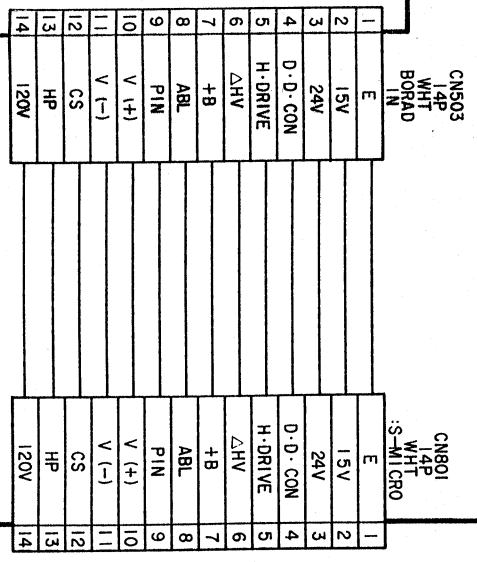

D
(DEFLECTION SYSTEM)

FBT H
FBT FOCUS
FBT SCREE

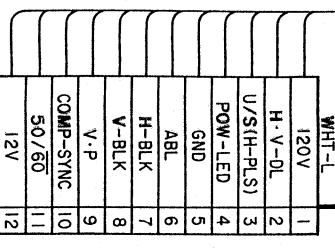
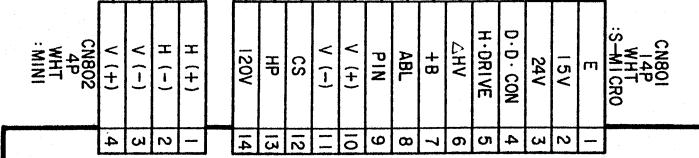
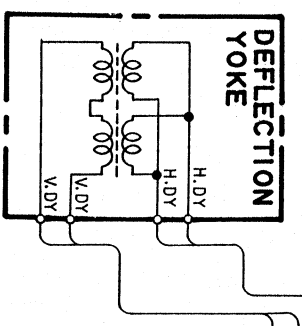
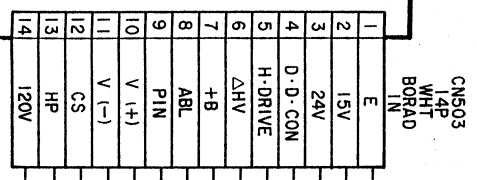
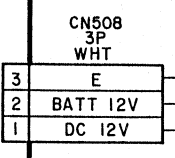
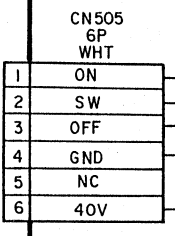
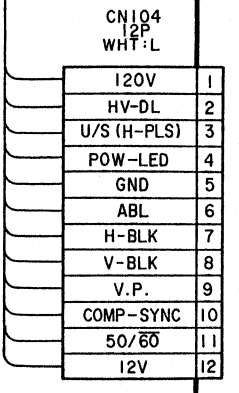
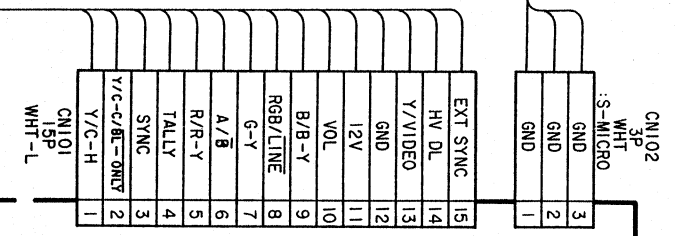
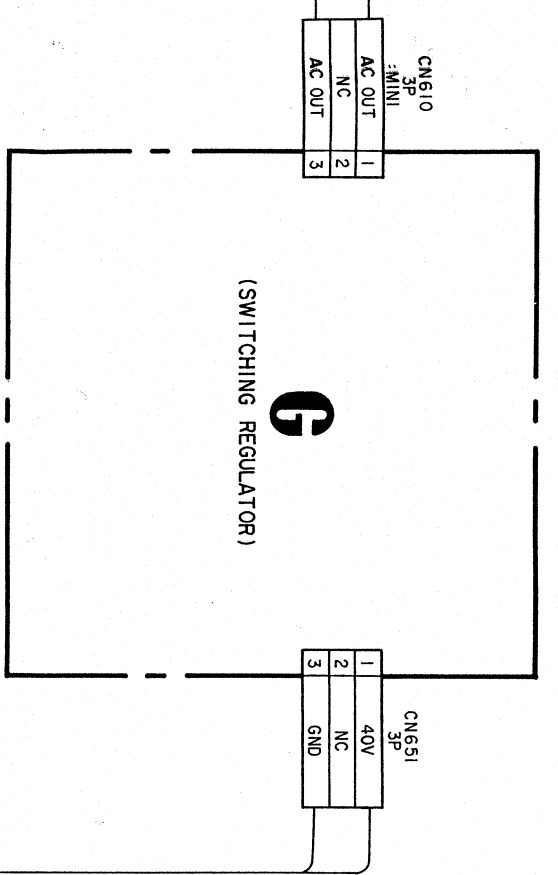

TO GND
REAR CHASSIS)

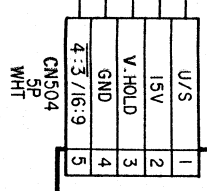

D
(DEFLECTION SYSTEM)

B
(SIGNAL PROCESS)

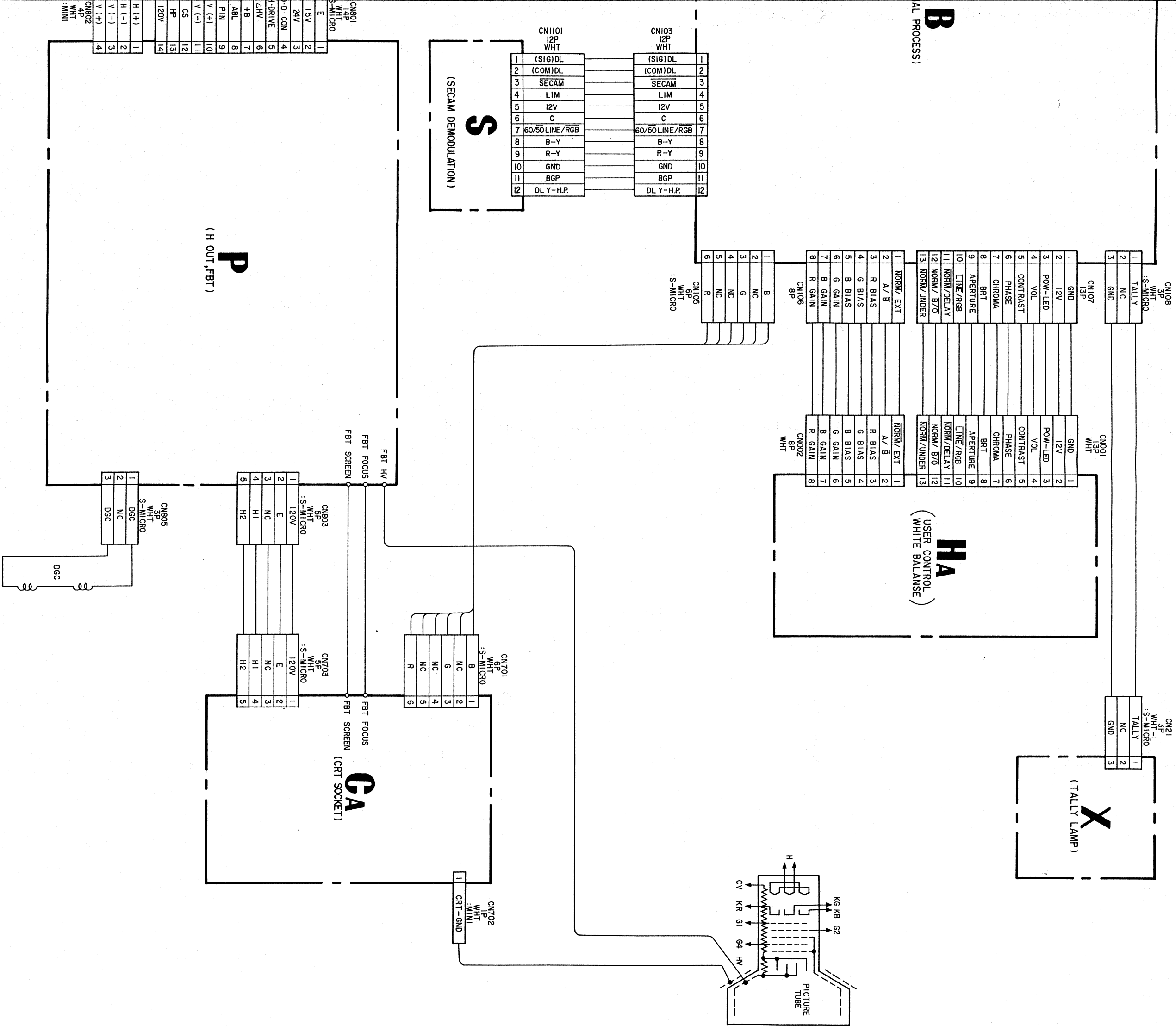

B
AL PROCESS)

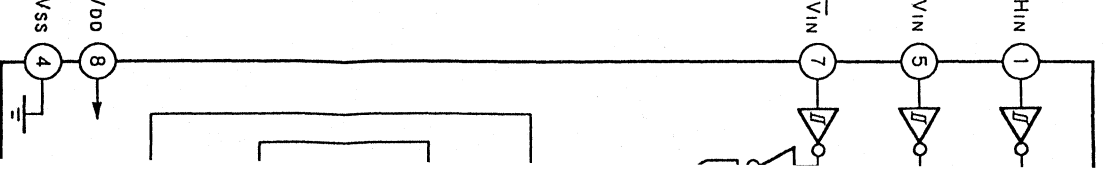

• D BOARD W

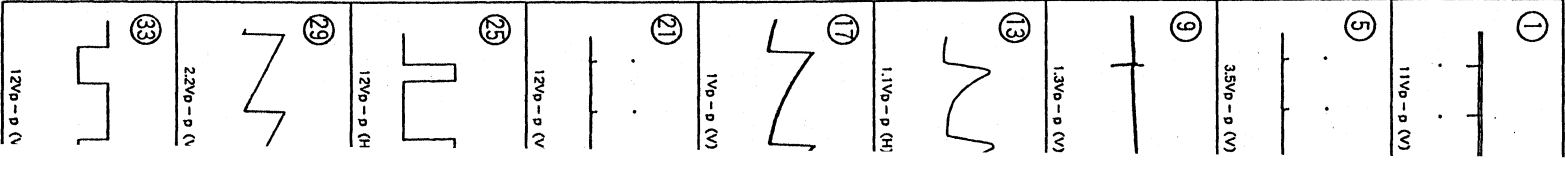

6-3. CIRCUIT BOARDS LOCATION

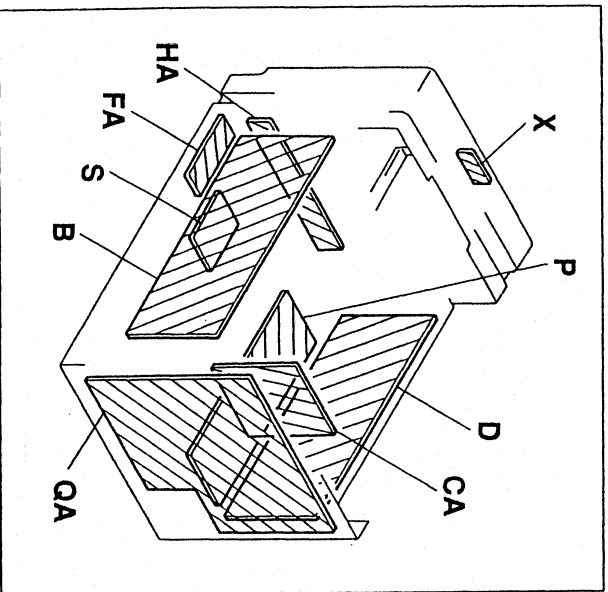

6-4. PRINTED WIRING BOARDS AND SCHEMATIC DIAGRAMS

Note:

- All capacitors are in μF unless otherwise noted. pF: μF 50WV or less are not indicated except for electrolytics.
- Indication of resistance, which does not have one for rating electrical power, is as follows.

Pitch: 5 mm
Rating electrical power 1/4W

- All resistors are in ohms.
 - : nonflammable resistor.
 - : fusible resistor.
 - : internal component.
 - : panel designation.
 - All variable and adjustable resistors have characteristic curve B, unless otherwise noted.
 - The components identified by in this basic schematic diagram have been carefully factory-selected for each set in order to satisfy regulations regarding X-ray radiation.
 - Should replacement be required, replace only with the value originally used.
 - When replacing components identified by , make the necessary adjustments indicated. If results do not meet the specified value, change the component identified by and repeat the adjustment until the specified value is achieved.
- (Refer to RV651, RV1603 and RV833 adjust on Page 19 and 20.)
- When replacing the part in below table be sure to perform the related adjustment.

Part replaced ()	Adjustment ()
IC601, IC651, PH601, C654, R653, R655, R656, R657, RV651—G BOARD	RV651 (B+ MAX)
Q1601, Q1602, Q1603, D1601, D1602, D1603, D1622, C1601, C1602, R1601, R1602, R1603, R1604, R1605, R1606, R1607, R1608, R1628, R1629, R1630, RV1601, RV1603—D BOARD	RV1603 (B+ MAX IN DC POWER INPUT MODE)
IC502, Q833, Q834, Q835, Q836, D835, D836, C519, C843, C844, C845, C846, C847, C848, RV833, R523, R850, R851, R852, R853, R854, R855, R856, R857, R858, R859, R860, R861, R862, R863—D BOARD NL801, T802, C814—P BOARD	RV833 (HOLD-DOWN)

- All voltages are in V.
- Voltage are dc with respect to ground unless otherwise noted.
- Readings are taken with a color-bar signal input.
- Readings are taken with a PAL color-bar signal input.
- : adjustment for repair.
- Voltage variations may be noted due to normal production tolerance.
- : B+ bus.
- : B- bus.
- : signal path.
- No mark : with PAL color-bar signal received or common voltage.
- () : with SECAM color-bar signal received.
- < > : with NTSC 3.58 color-bar signal received.
- (()) : with NTSC 4.43 color-bar signal received.
- [] : with S (Y/C) color-bar signal received.
- { } : with analog RGB color-bar signal received.
- << >> : with component color-bar signal received.

Reference information

RESISTOR	RN	METAL FILM
: RC	SOLID	
: FPRD	NONFLAMMABLE CARBON	
: FUSE	NONFLAMMABLE FUSIBLE	
: RS	NONFLAMMABLE WIREWOUND	
: RB	NONFLAMMABLE CEMENT	
COIL	LF-8L	MICRO INDUCTOR
CAPACITOR	TA	TANTALUM
: PS	STYROL	
: PP	POLYPROPYLENE	
: PT	MYLAR	
: MPS	METALIZED POLYESTER	
: MPP	METALIZED POLYPROPYLENE	
: ALB	BIPOLAR	
: ALT	HIGH TEMPERATURE	
: ALR	HIGH RIPPLE	

Note: The components identified by shading and mark are critical for safety. Replace only with part number specified.

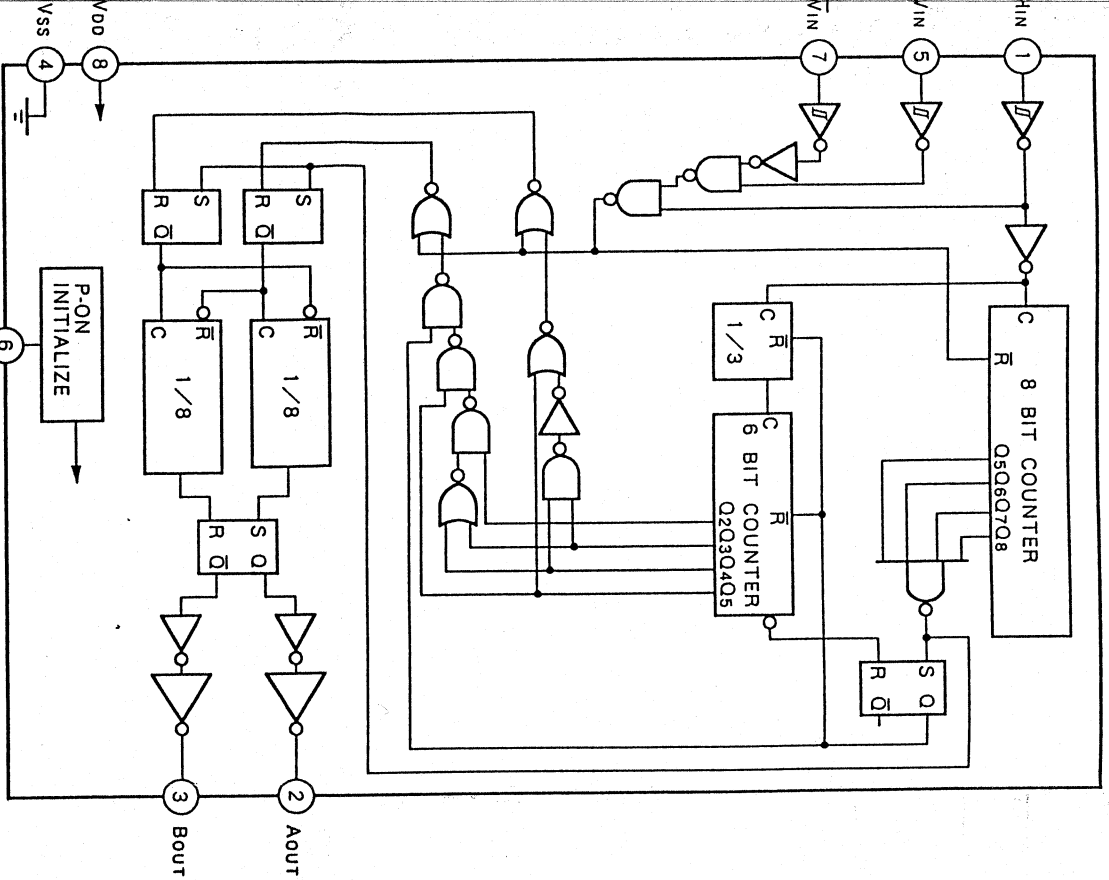

D BOARD WAVEFORMS

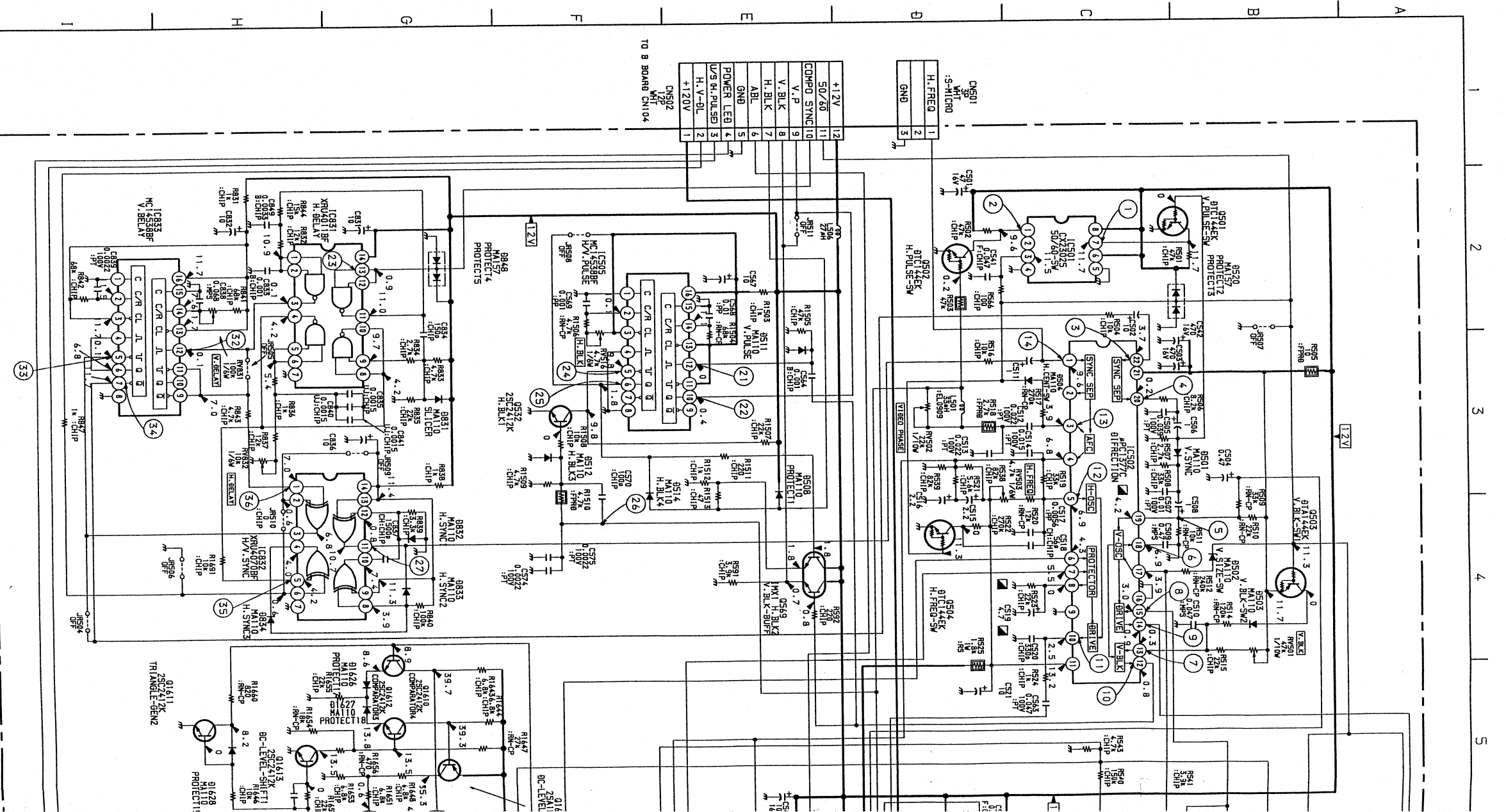
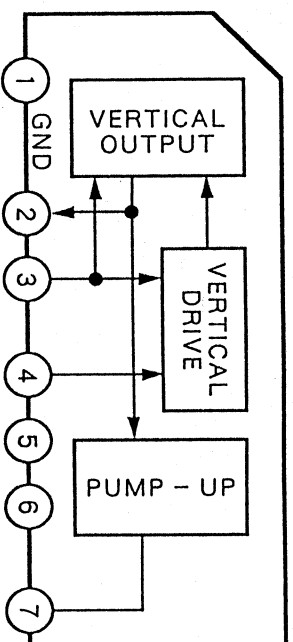
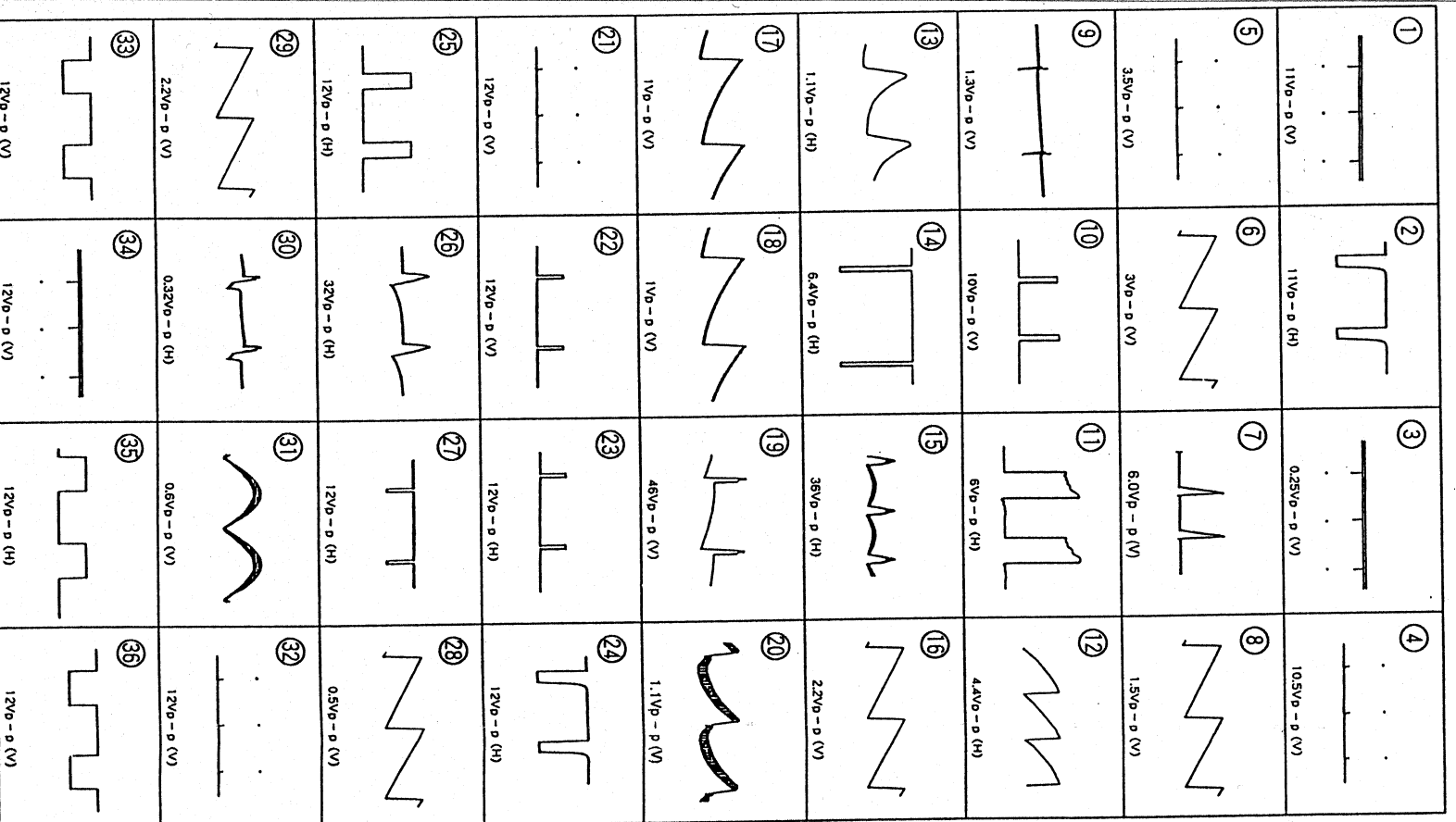

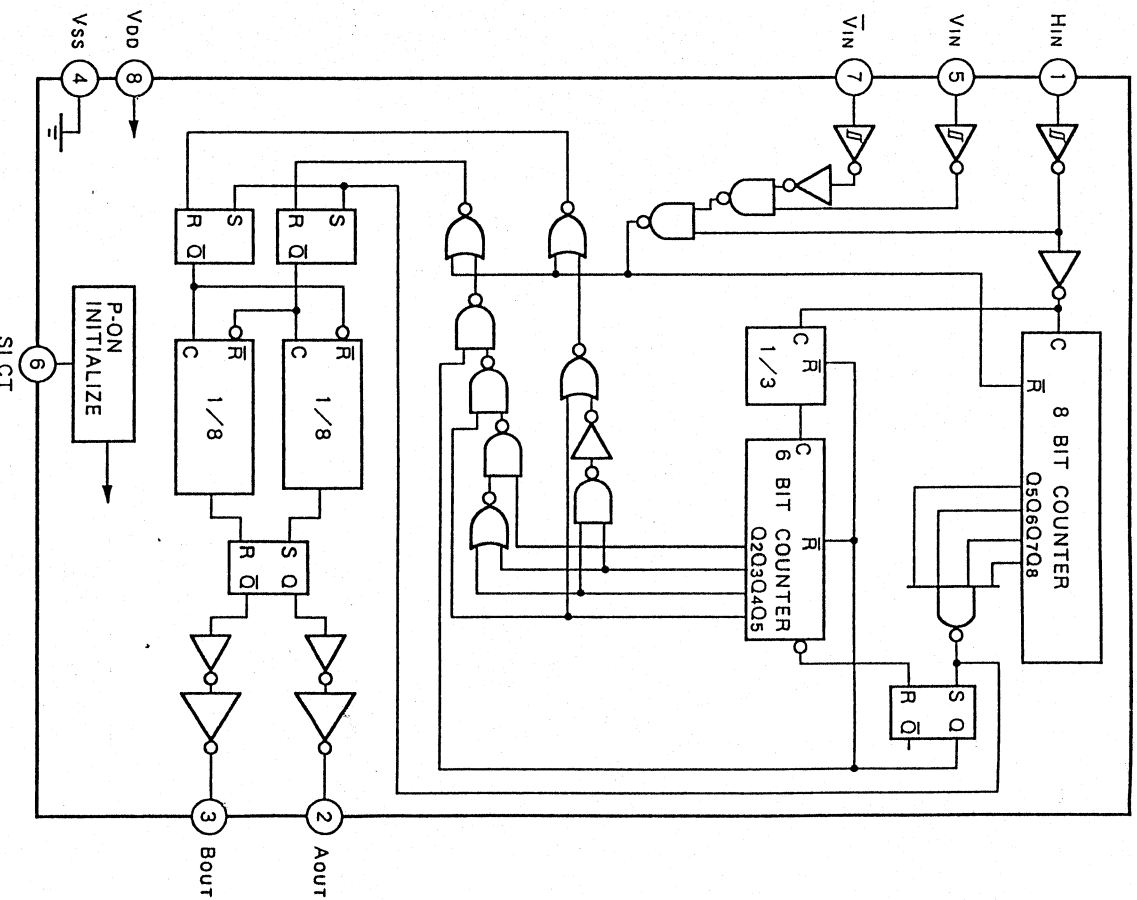

• D BOARD WAVEFORMS

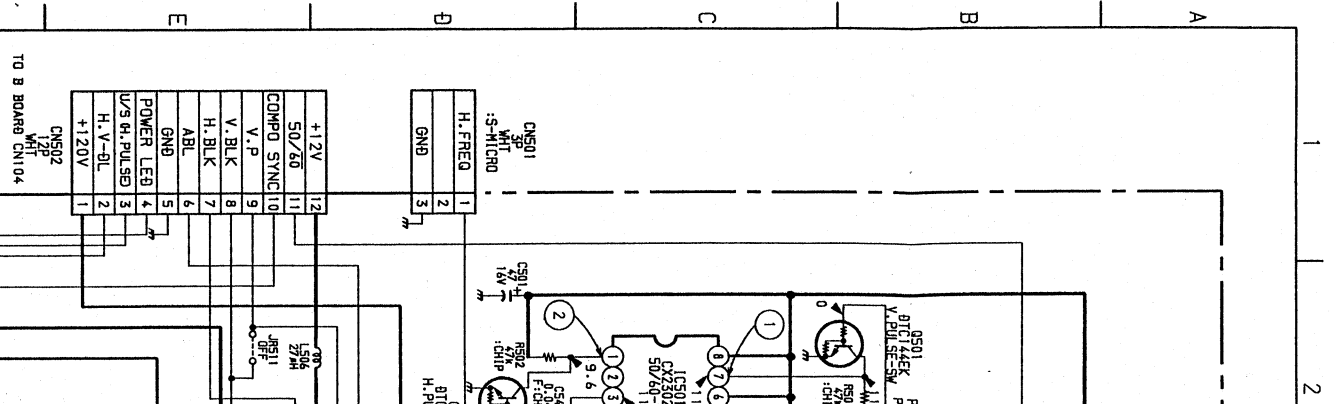
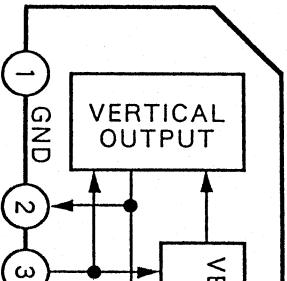
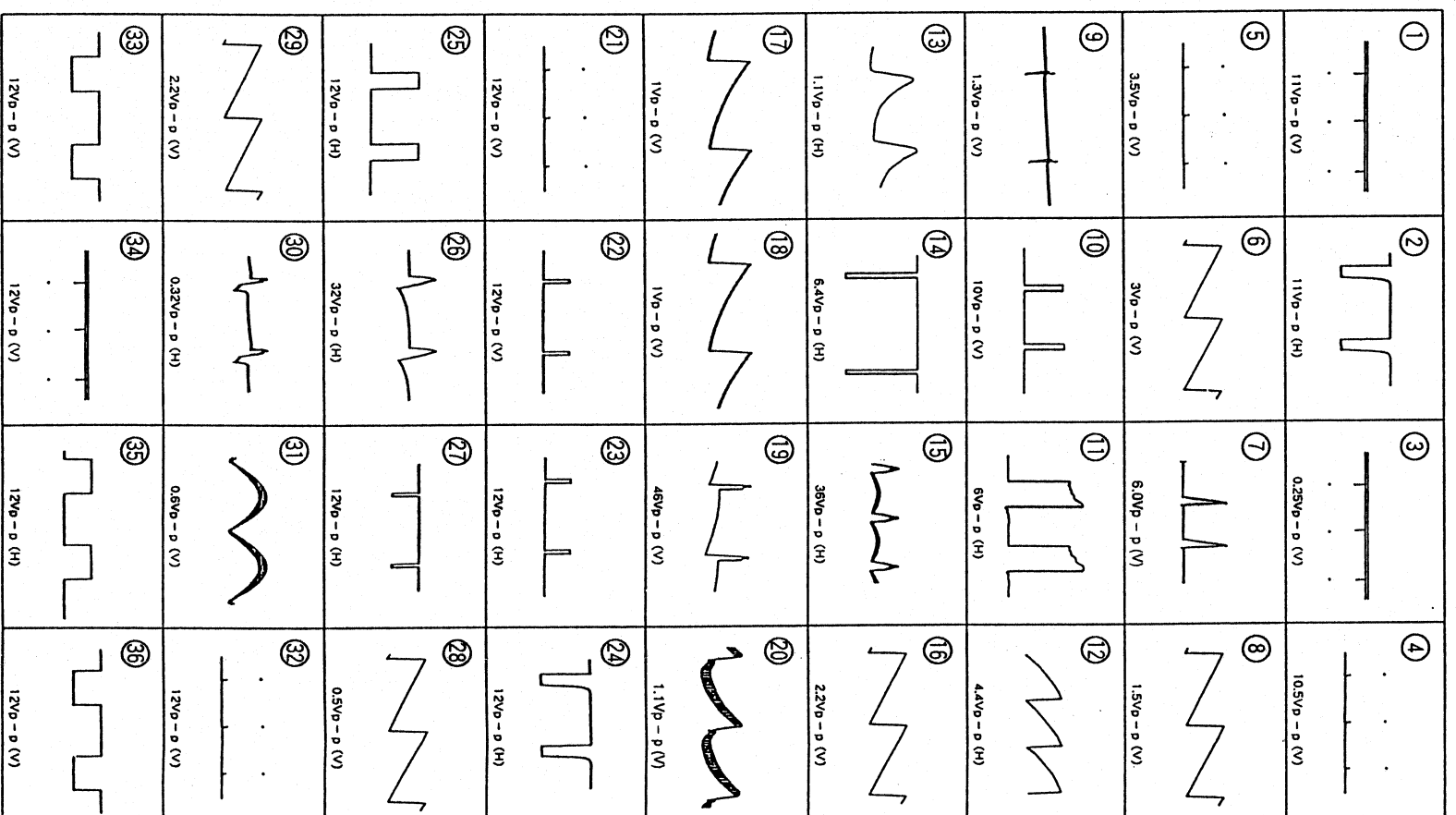

D BOARD IC503 LA7830

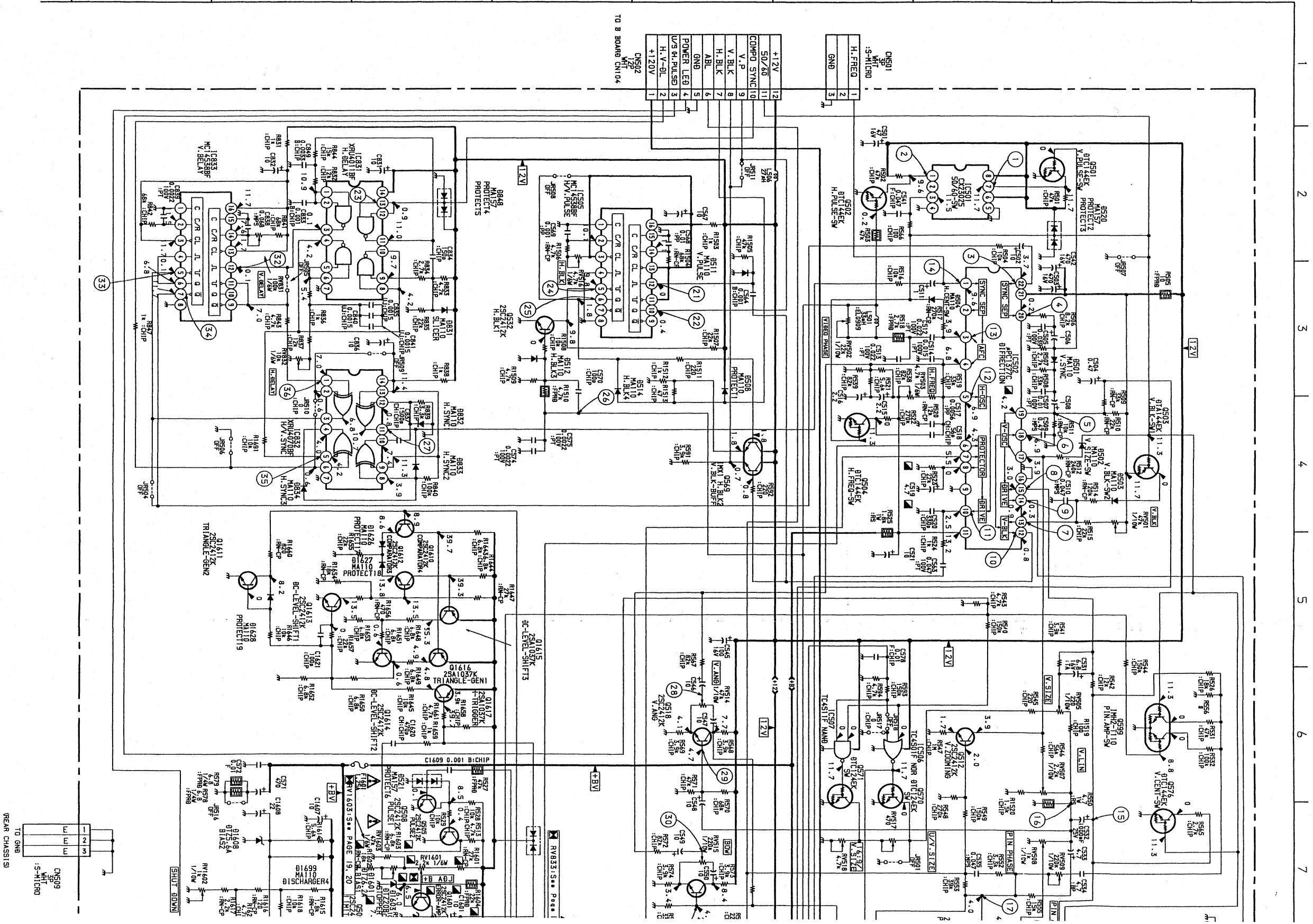
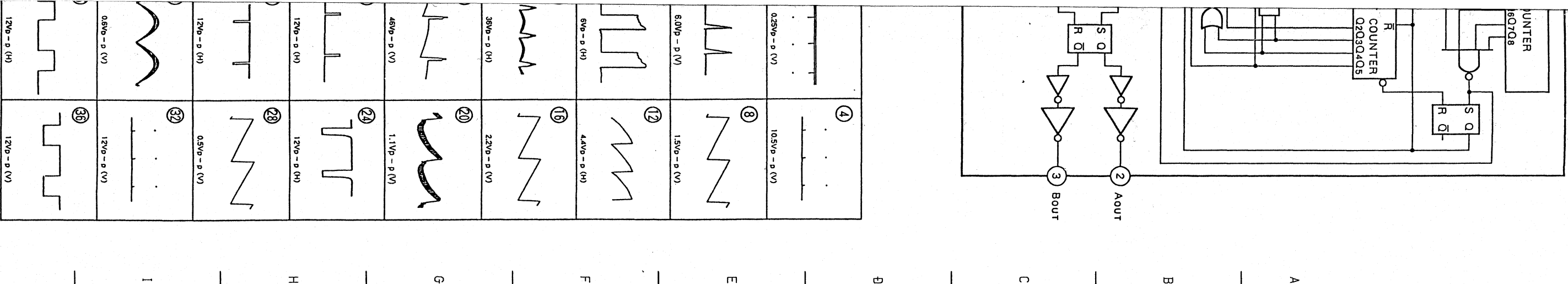
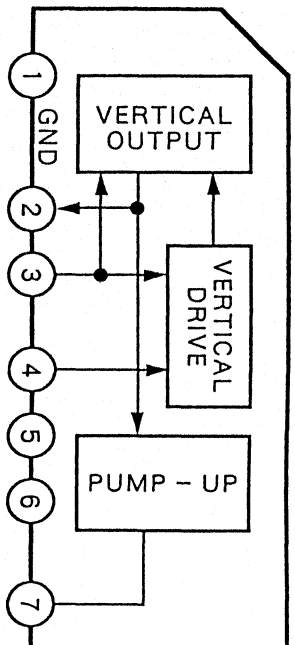

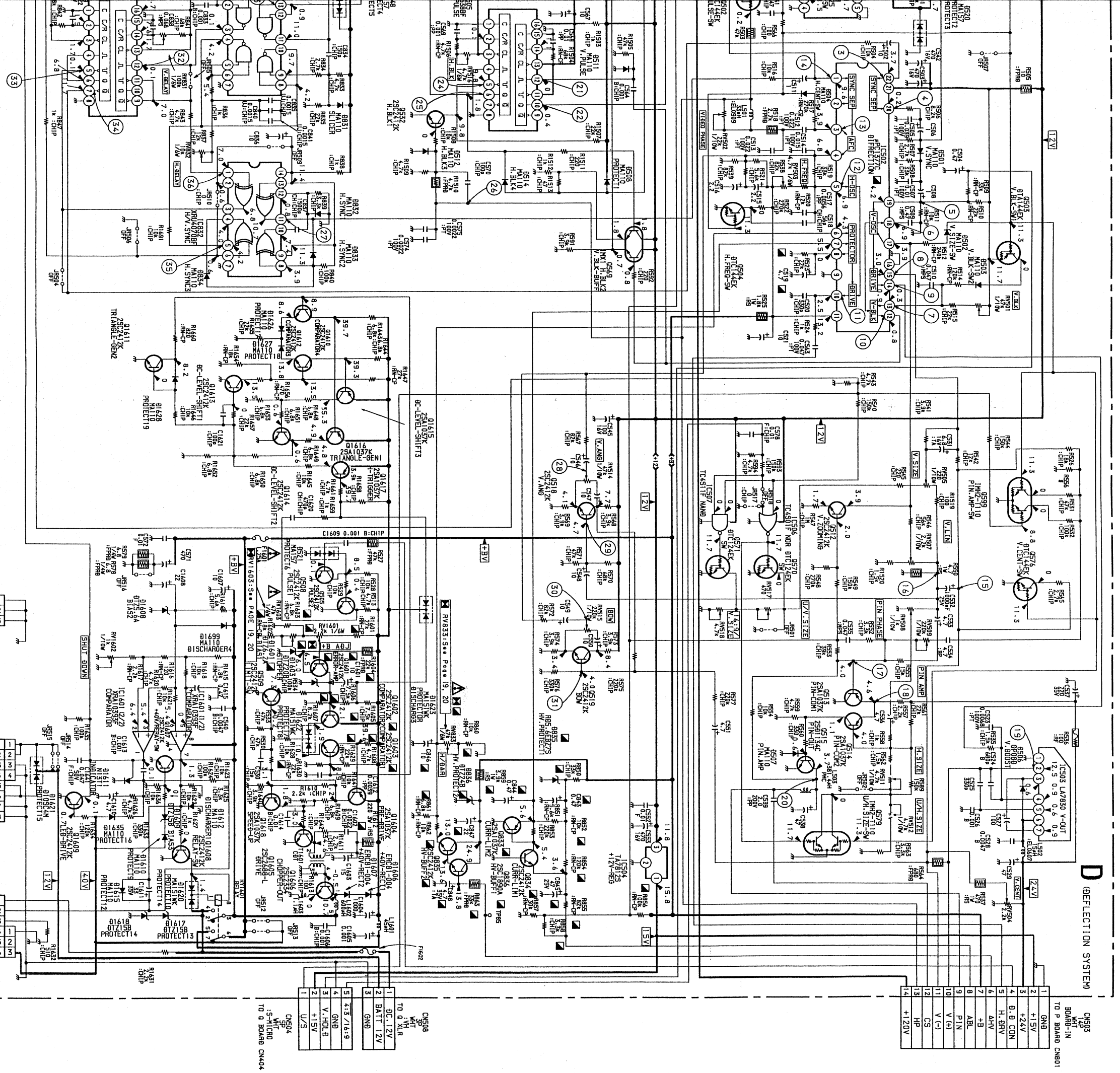
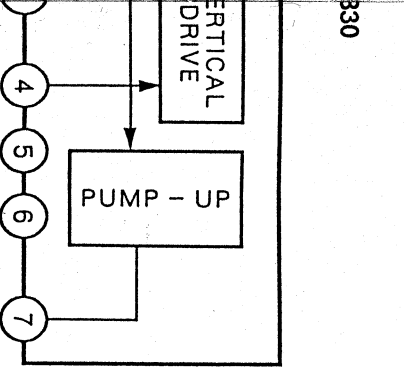

CN503 BOARD-IN TO P BOARD CN801

1	GND
2	+15V
3	+24V
4	G-B CON
5	H-DRV
6	4HV
7	+B
8	A-BL
9	PIN
10	V (+)
11	V (-)
12	CS
13	HP
14	+120V

CN508 TO G XLR

1	DC 12V
2	BATT 12V
3	GND
4	GND
5	433 /16+9
6	GND
7	V-HOLD
8	+15V
9	U/S

CN504 TO G BOARD CN404

1	DC 12V
2	BATT 12V
3	GND
4	GND
5	433 /16+9
6	GND
7	V-HOLD
8	+15V
9	U/S

CN505 TO FA BOARD CN403

1	BATT IN
2	BATT IN
3	BATT IN
4	BATT IN
5	BATT IN
6	BATT IN
7	BATT IN
8	BATT IN
9	BATT IN
10	BATT IN
11	BATT IN
12	BATT IN
13	BATT IN
14	BATT IN
15	BATT IN
16	BATT IN
17	BATT IN
18	BATT IN
19	BATT IN
20	BATT IN
21	BATT IN
22	BATT IN
23	BATT IN
24	BATT IN
25	BATT IN
26	BATT IN
27	BATT IN
28	BATT IN
29	BATT IN
30	BATT IN
31	BATT IN
32	BATT IN
33	BATT IN
34	BATT IN
35	BATT IN
36	BATT IN
37	BATT IN
38	BATT IN
39	BATT IN
40	BATT IN
41	BATT IN
42	BATT IN
43	BATT IN
44	BATT IN
45	BATT IN
46	BATT IN
47	BATT IN
48	BATT IN
49	BATT IN
50	BATT IN
51	BATT IN
52	BATT IN
53	BATT IN
54	BATT IN
55	BATT IN
56	BATT IN
57	BATT IN
58	BATT IN
59	BATT IN
60	BATT IN
61	BATT IN
62	BATT IN
63	BATT IN
64	BATT IN
65	BATT IN
66	BATT IN
67	BATT IN
68	BATT IN
69	BATT IN
70	BATT IN
71	BATT IN
72	BATT IN
73	BATT IN
74	BATT IN
75	BATT IN
76	BATT IN
77	BATT IN
78	BATT IN
79	BATT IN
80	BATT IN
81	BATT IN
82	BATT IN
83	BATT IN
84	BATT IN
85	BATT IN
86	BATT IN
87	BATT IN
88	BATT IN
89	BATT IN
90	BATT IN
91	BATT IN
92	BATT IN
93	BATT IN
94	BATT IN
95	BATT IN
96	BATT IN
97	BATT IN
98	BATT IN
99	BATT IN
100	BATT IN

D DEFLECTION SYSTEM

- D BOARD - (Component Side)

D BOARD (Component Side)

IC		D512 B-4
IC501 B-1	D514 A-5	D520 B-1
IC502 B-2	D521 D-8	D833 A-6
IC503 C-6	D834 A-6	D835 B-3
IC504 B-5	D836 B-3	D848 C-6
IC505 B-5	D1606 C-8	D1607 A-8
IC506 C-4	D1609 D-7	D1610 D-7
IC507 C-3	D1611 D-9	D1621 A-9
IC831 C-7	D1626 D-8	D1627 D-8
IC832 A-6	D1628 D-8	
IC833 B-6		
IC1601 D-8		
TRANSISTOR		
Q505 D-8		
Q508 D-8		
Q509 C-8		
Q512 C-2		
Q514 A-5		
Q515 D-1		
Q532 A-4		
Q569 A-4		
Q571 C-3		
Q576 D-2		
Q579 D-2		
Q599 C-1		
Q836 B-3		
Q1605 B-7		
Q1606 A-8		
Q1607 E-8		
Q1610 D-7		
Q1611 D-8		
Q1612 C-8		
Q1613 D-9		
Q1614 D-8		
Q1615 C-8		
Q1616 C-8		
Q1617 C-8		
Q1618 C-8		
DIODE		
D506 D-6		
D508 A-4		
	VARIABLE RESISTOR	
	RV501 A-3	
	RV502 D-3	
	RV503 C-2	
	RV504 D-4	
	RV505 D-3	
	RV507 D-3	
	RV508 D-3	
	RV509 D-3	
	RV511 D-2	
	RV512 D-2	
	RV514 D-3	
	RV515 C-3	
	RV516 A-3	
	RV517 D-3	
	RV518 C-2	
	RV831 A-6	
	RV832 A-6	
	RV833 B-3	
	RV1601 D-8	
	RV1602 D-8	
	RV1603 D-8	

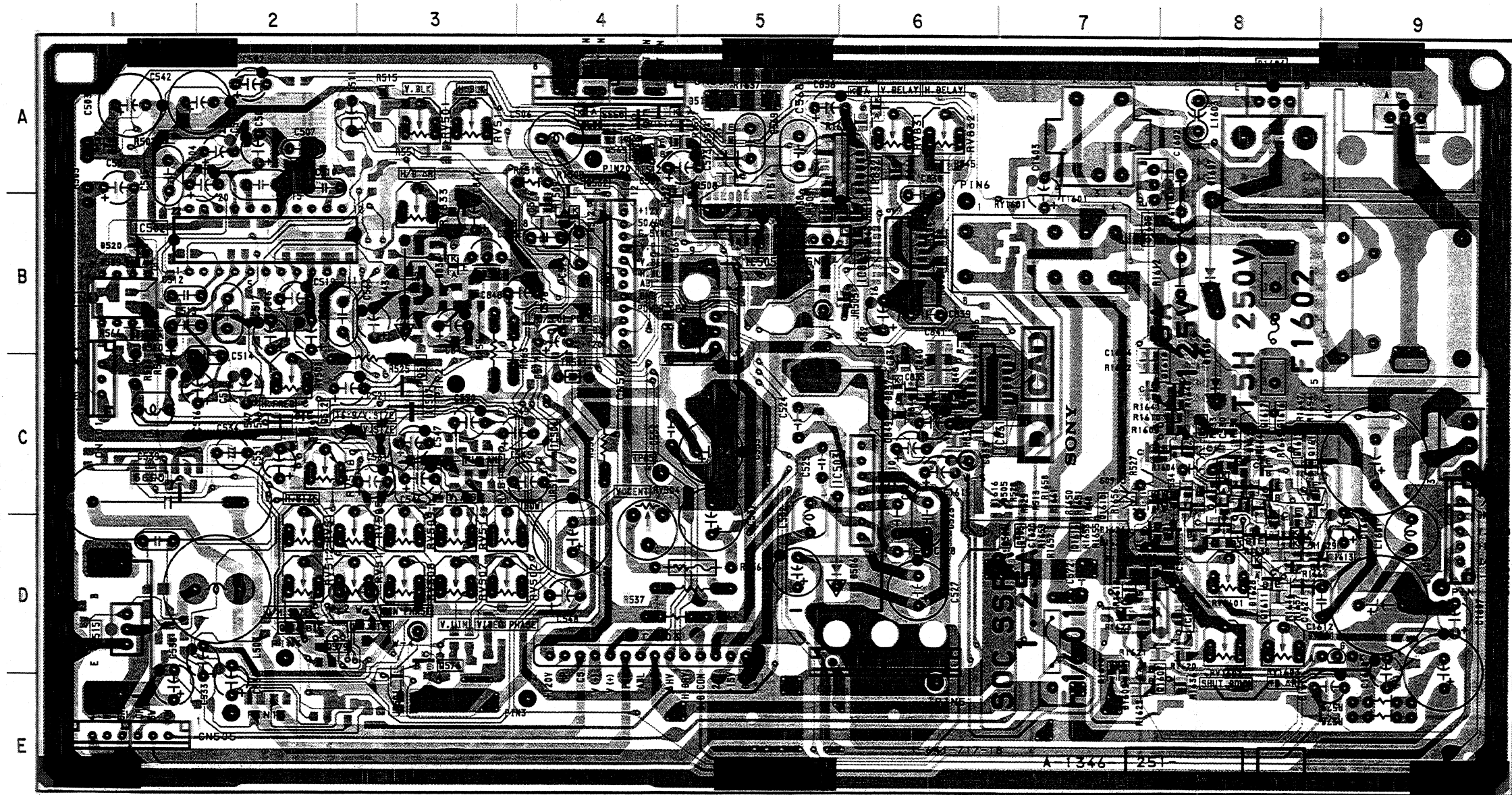

- D BOARD -

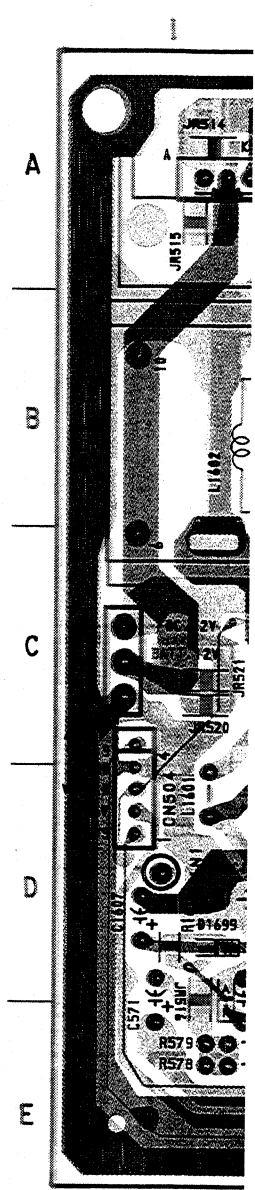

- D BOARD - (Conductor Side)

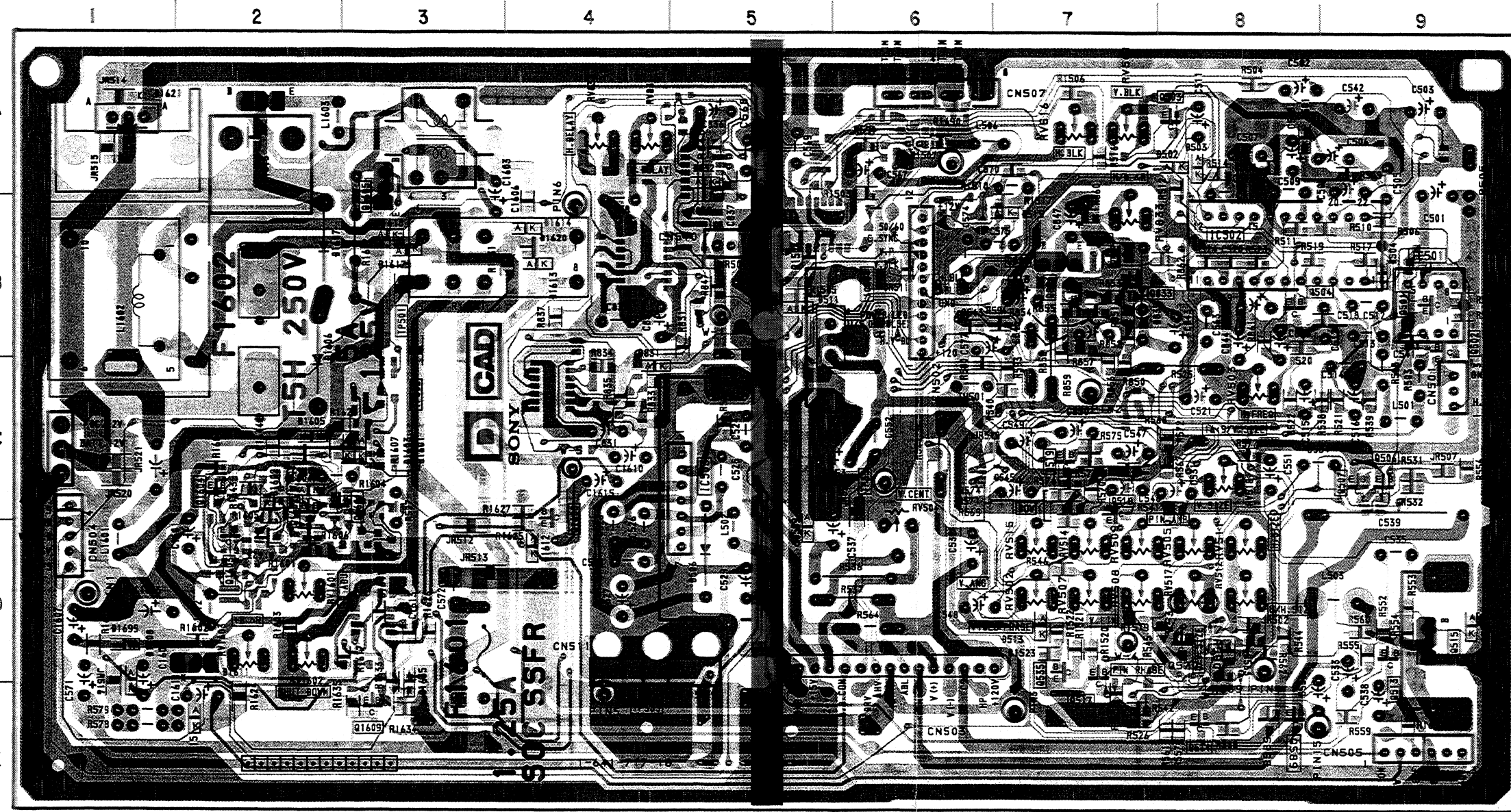

D BOARD (Conductor Side)

IC		D835	B-7
IC501	B-9	D1601	C-3
IC502	B-8	D1603	C-3
IC503	C-5	D1606	B-2
IC504	B-6	D1607	B-2
		D1608	D-1
		D1611	D-2
		D1612	D-4
		D1615	E-2
		D1617	B-3
		D1618	B-3
		D1620	B-4
		D1621	A-1
		D1622	C-2
		D1623	D-2
		D1635	D-3
		D1699	D-1
TRANSISTOR		VARIABLE RESISTOR	
Q501	B-9	RV501	A-7
Q502	B-9	RV502	D-7
Q503	A-8	RV503	C-8
Q504	B-8	RV504	C-6
Q513	D-9	RV505	D-8
Q514	E-8	RV507	D-7
Q515	D-9	RV508	D-7
Q518	C-7	RV509	D-7
Q519	C-7	RV511	D-8
Q570	D-8	RV512	D-8
Q833	B-7	RV514	D-7
Q834	B-7	RV515	D-7
Q835	B-7	RV516	A-7
Q836	B-7	RV517	D-8
Q1601	C-2	RV518	C-8
Q1602	C-2	RV831	A-4
Q1603	D-2	RV832	A-4
Q1604	C-2	RV833	B-7
Q1605	A-3	RV6101	D-2
Q1606	A-2	RV1602	D-2
Q1608	C-4	RV1603	D-2
Q1609	E-3		
DIODE			
D501	A-8		
D502	A-8		
D503	A-8		
D504	B-9		
D506	D-5		
D507	D-9		
D511	B-5		
D831	C-4		
D832	A-5		

Note:
 • [Pattern] : Pattern from the side which enables seeing.
 • [Pattern] : Pattern of the rear side.

P [H OUT, FBT] **G** [SWITCHING REGULATOR] **X** [TALLY LAMP] **FA** [AC/DC SW] **HA** [USER CONTROL WHITE BALANCE] **CA** [CRT SOCKET] **QA** [INPUT SIGNAL SELECTOR] **S** [SECAM DEMODULATION]

- P BOARD -

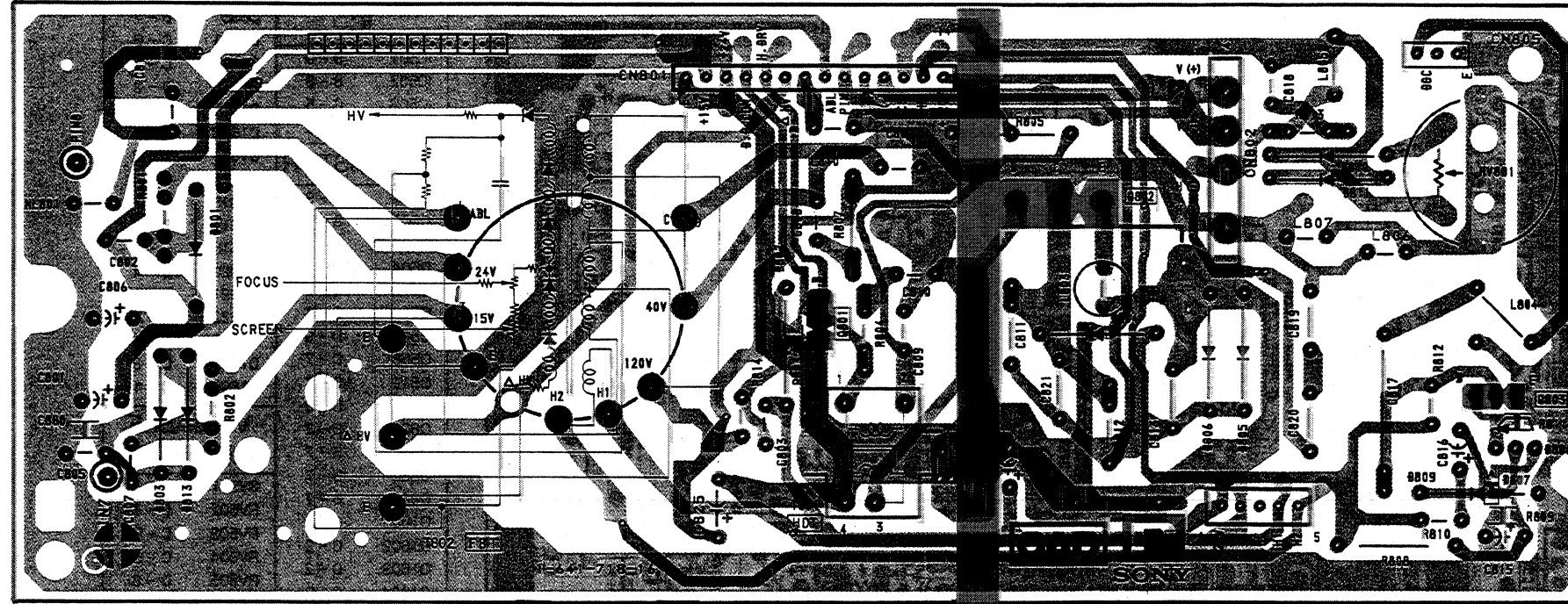

- X BOARD -

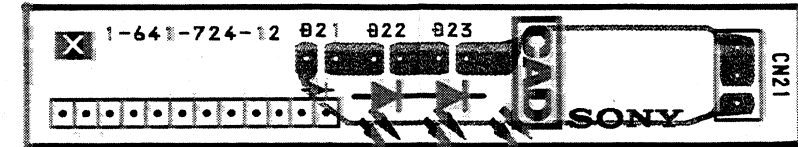

- FA BOARD -

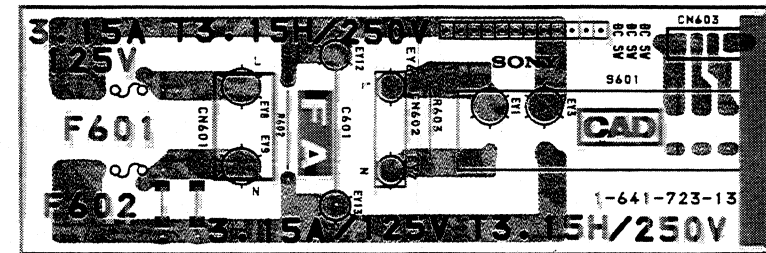

- HA BOARD -

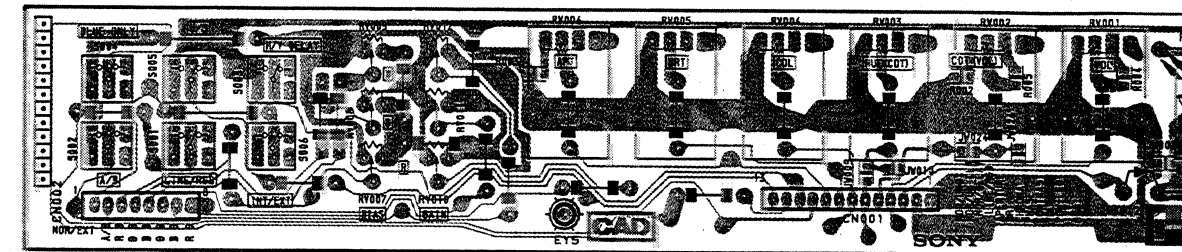

Note:

- : Pattern from the side which enables seeing.
- : Pattern of the rear side.

- G BOARD -

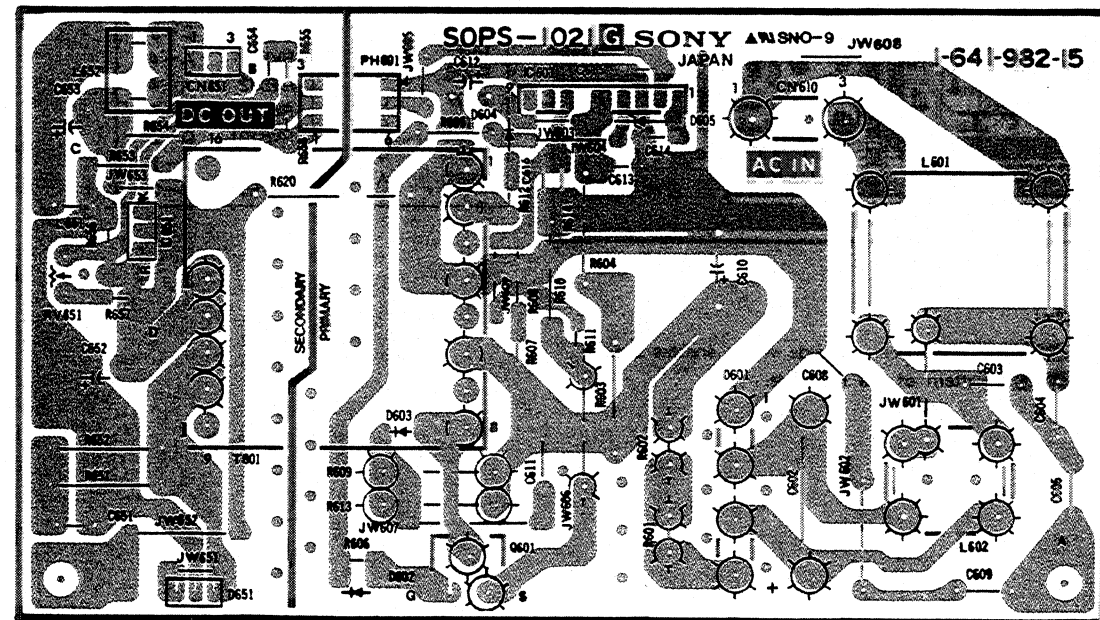

- CA BOARD -

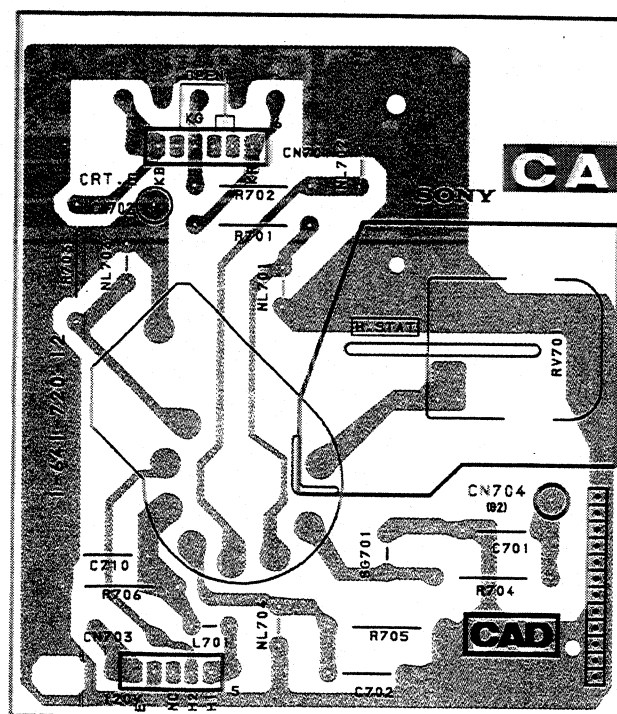

- S BOARD - (Component Side)

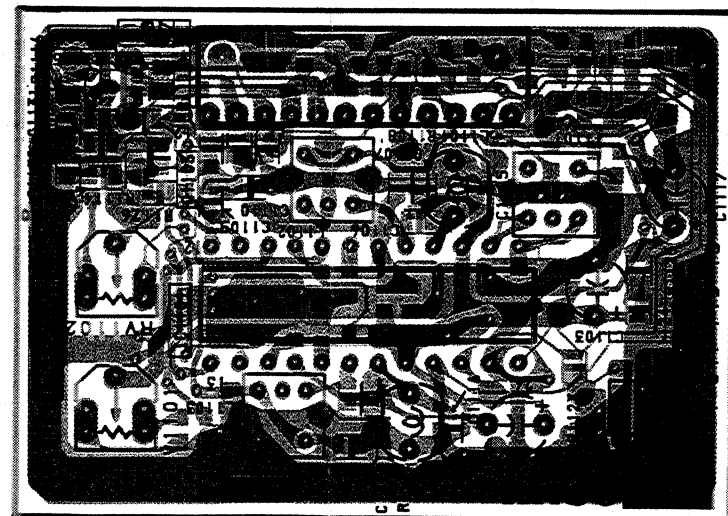

(Conductor Side)

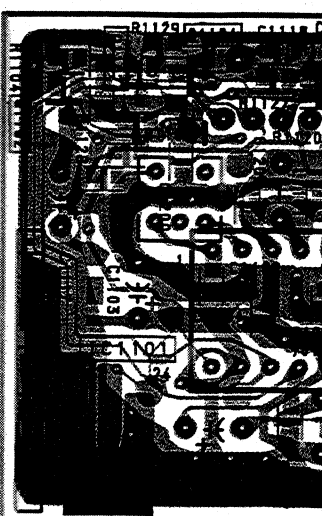

Note:

- : Pa
- : Pa

- QA BOARD -

QA BOARD

IC	D403	D-2	
IC401	B-3	D404	B-6
IC402	C-3	D405	B-6
IC403	E-3	D406	B-4
	D407	B-4	
TRANSISTOR	D408	B-6	
Q401	B-5	D409	C-6
Q402	B-4	D410	C-1
Q403	B-3	D411	C-1
Q404	B-6	D412	B-1
Q405	B-7	D413	B-1
Q406	D-7	D414	B-7
Q407	D-5	D415	B-7
Q408	A-7	D416	D-6
Q409	C-4	D418	D-5
Q410	D-2	D419	D-5
Q411	C-1	D420	D-4
Q412	B-5	D421	D-4
Q413	B-3	D422	D-2
Q414	D-3	D423	D-3
Q416	E-2	D424	B-1
Q417	C-1	D425	B-1
Q418	B-1	D426	B-1
Q419	B-1	D427	A-2
Q420	A-1	D428	B-1
Q421	B-2	D429	B-1
Q422	B-2	D430	B-2
Q423	B-1	D431	A-2
Q424	B-2		
Q426	D-7		
	VARIABLE RESISTOR		
	RV401	D-4	
DIODE			
D401	C-2		
D402	C-2		

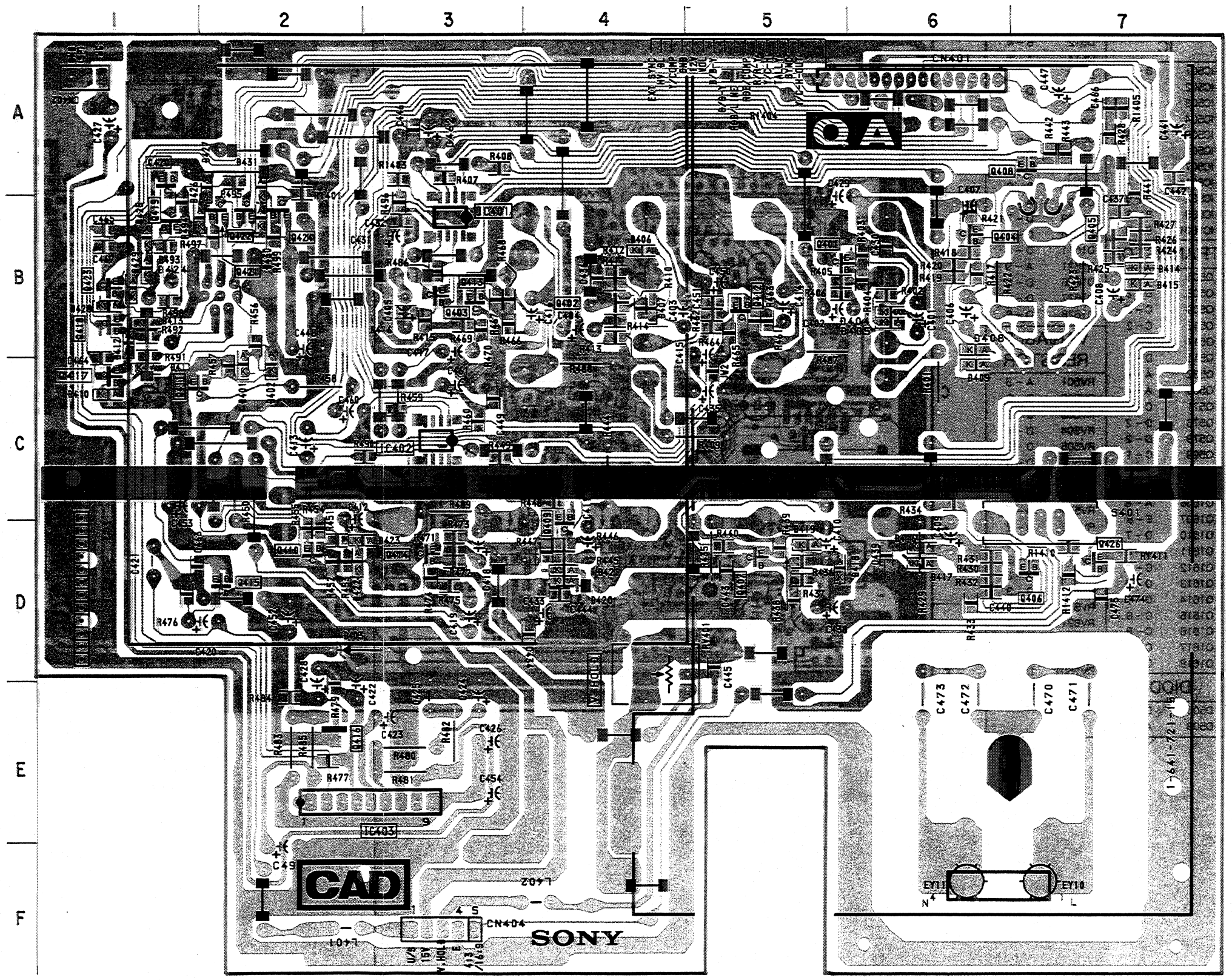
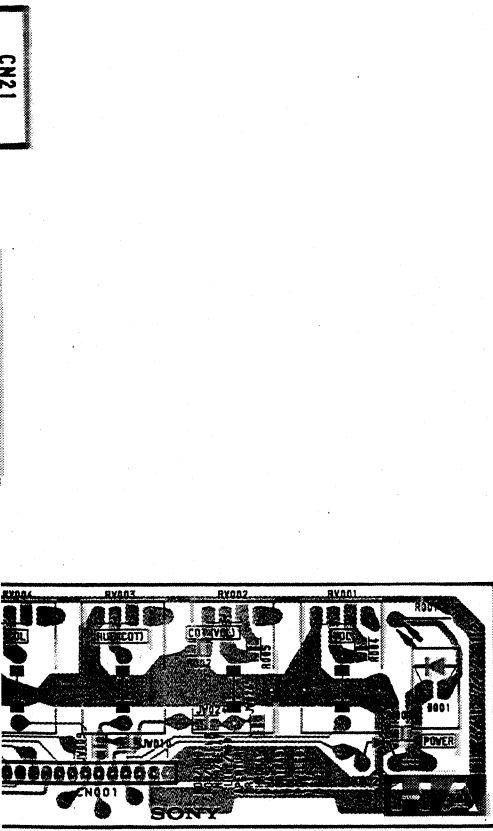

(Conductor Side)

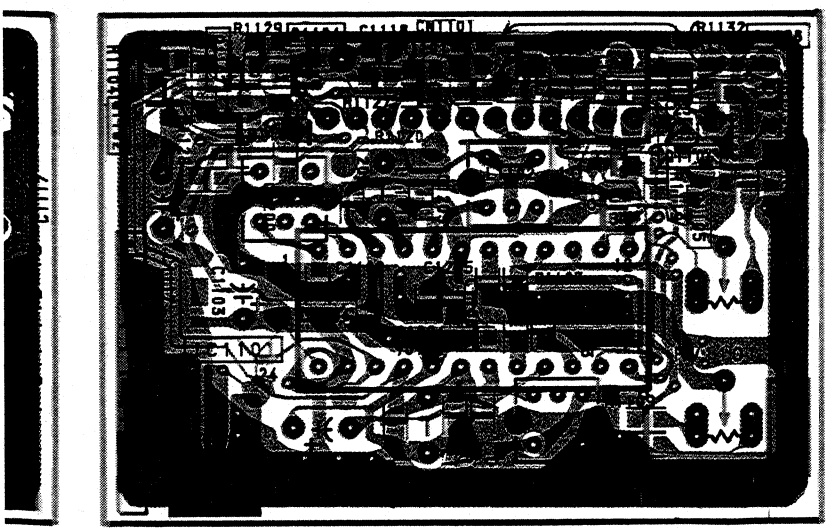

Note :
 • : Pattern from the side which enables seeing.
 • : Pattern of the rear side.

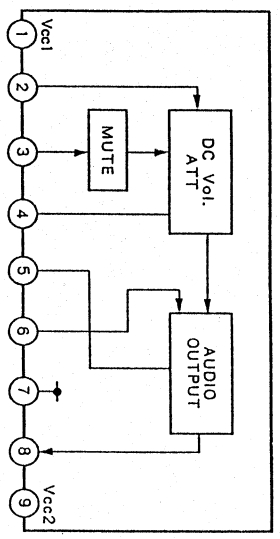
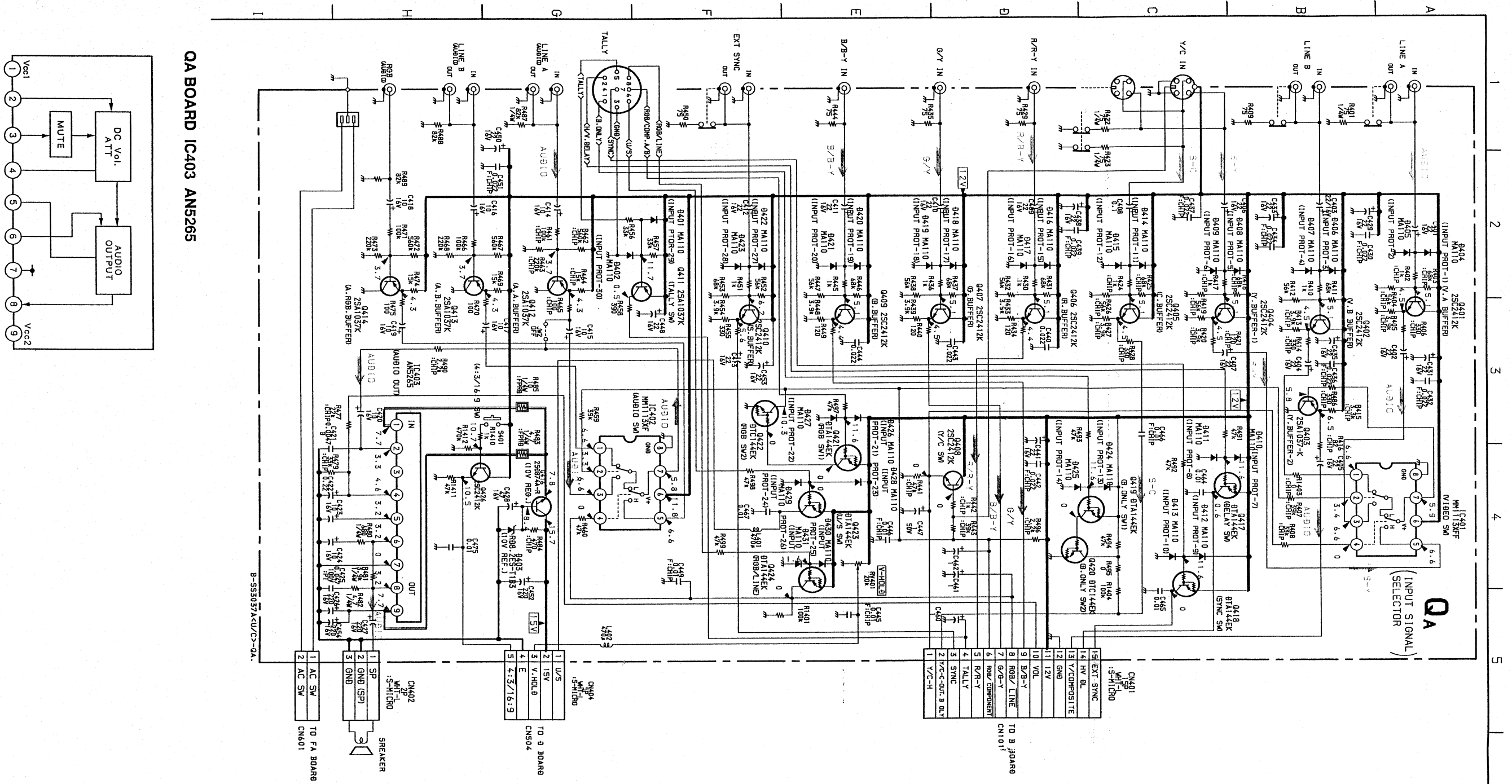

QA BOARD IC403 AN5265

B-553037A/KU/C-QA.

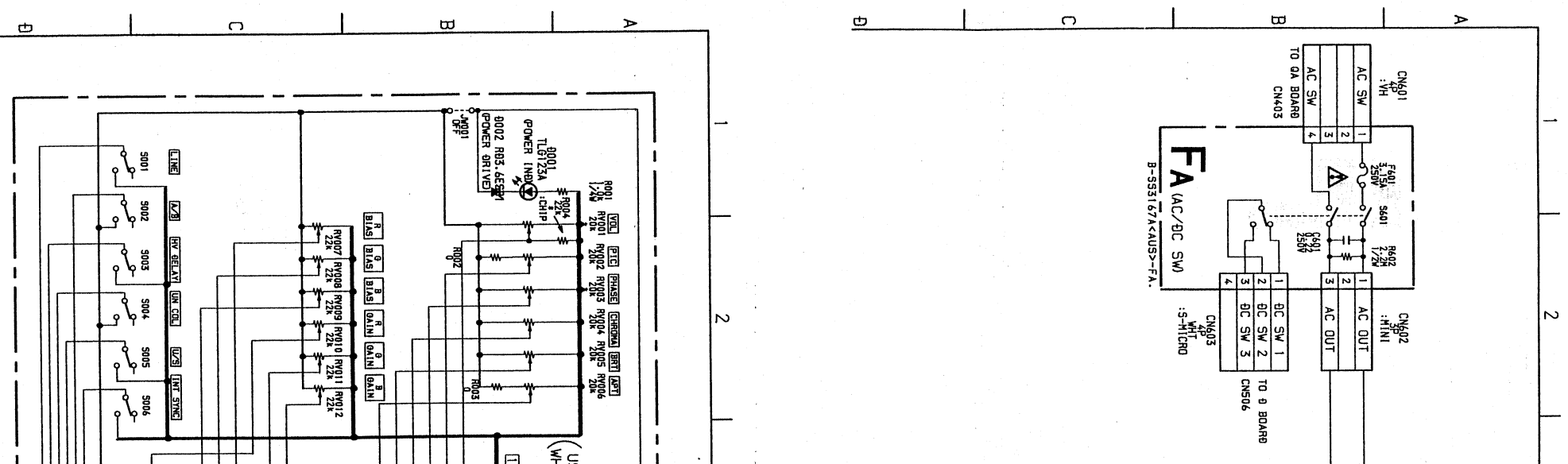

FA (AC/BC SW)

B-553157A/KUS-FA.

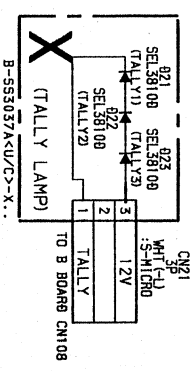

(TALLY LAMP)

B-553037A/KU/C-X.

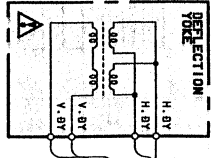
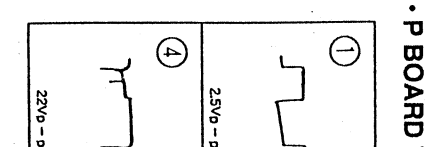
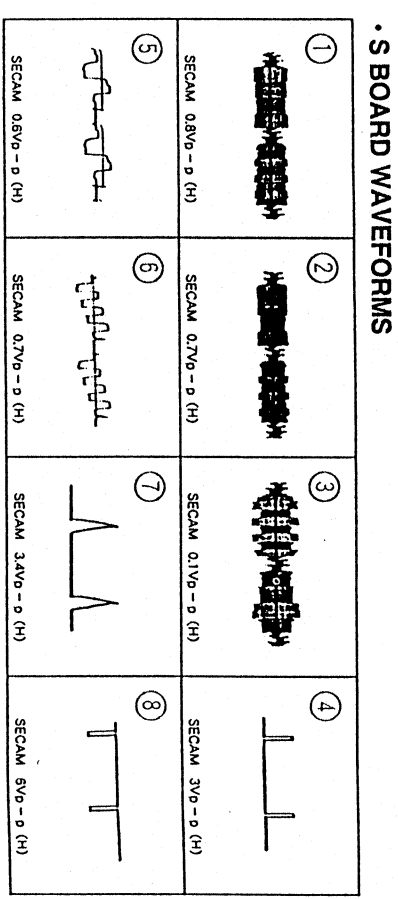
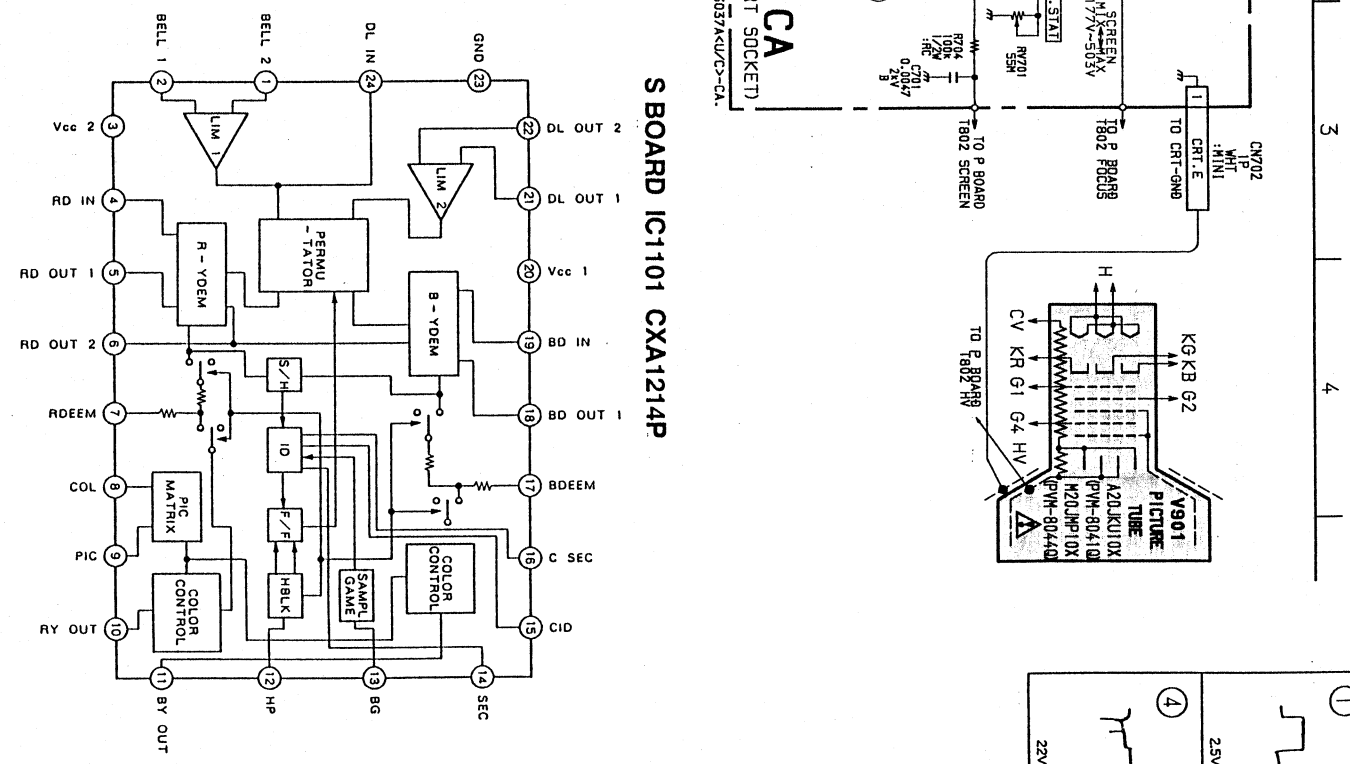
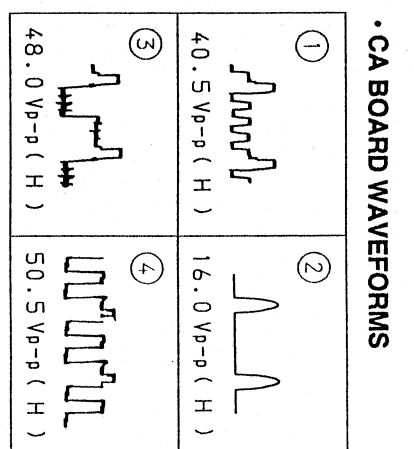
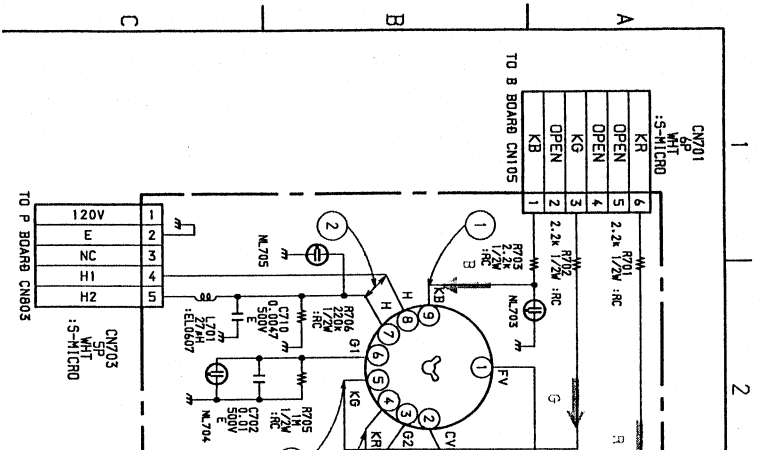
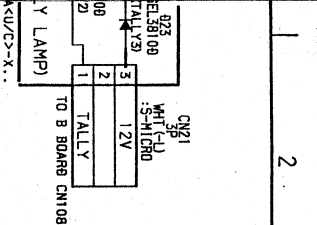
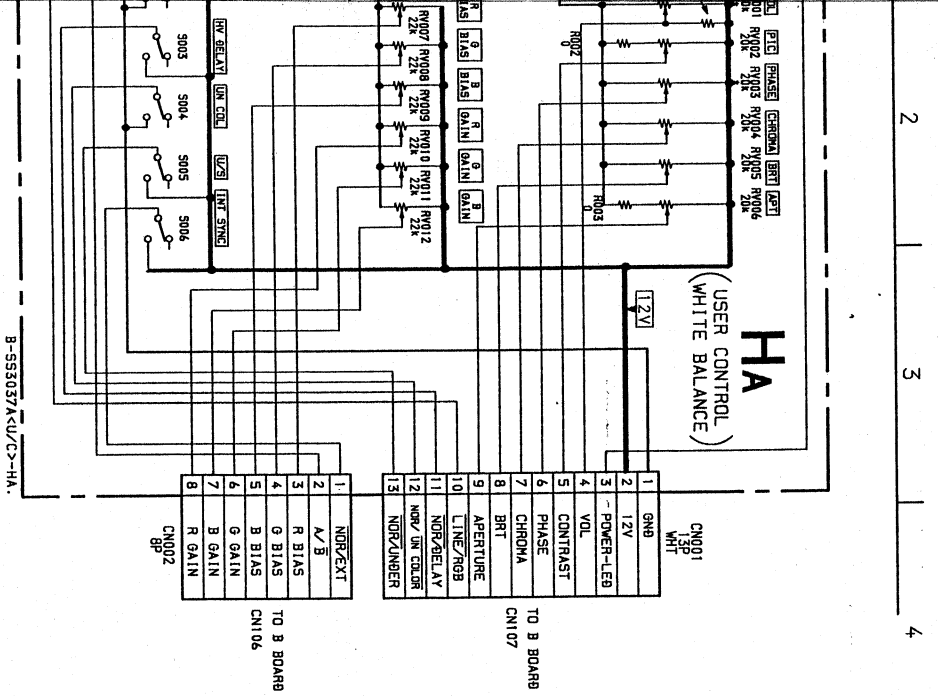
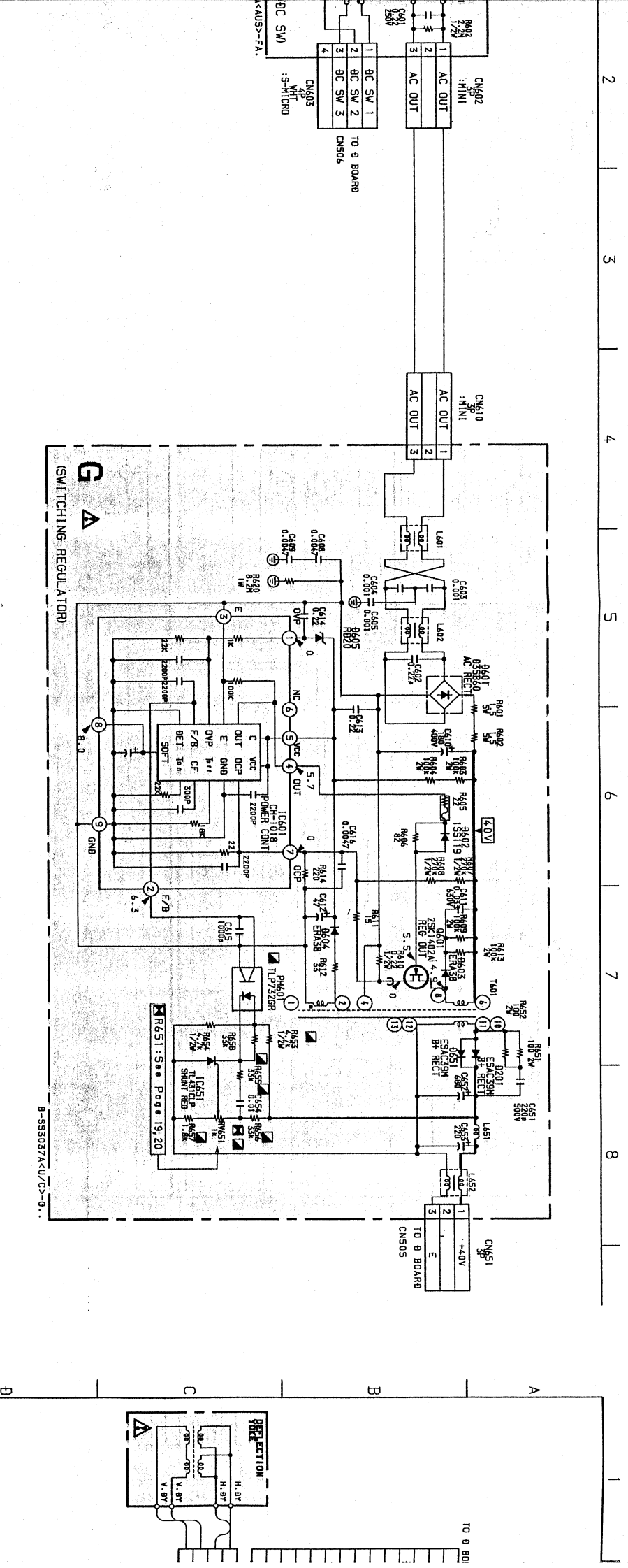

2 3 4 5 6 7 8

2 3 4

2

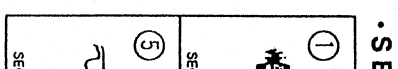
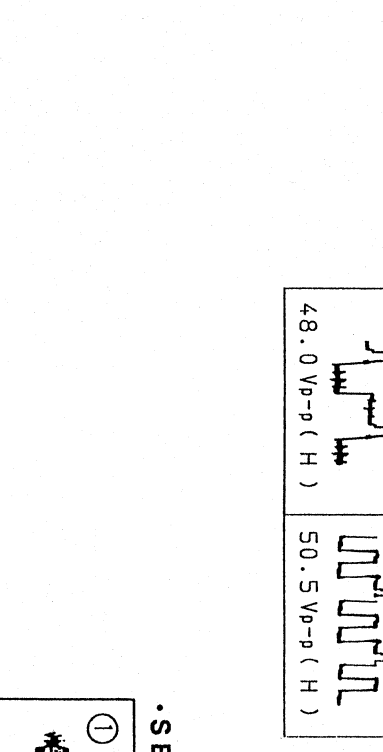
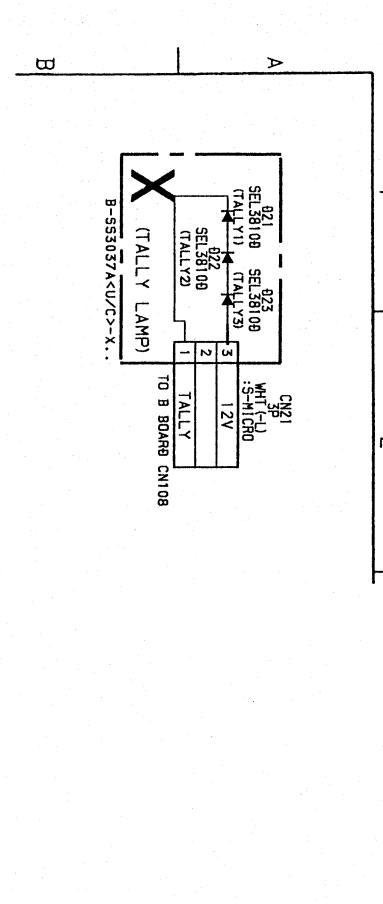
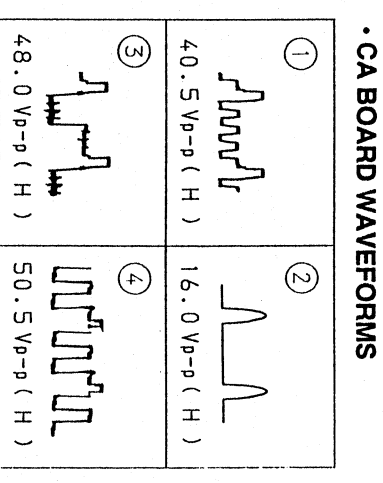
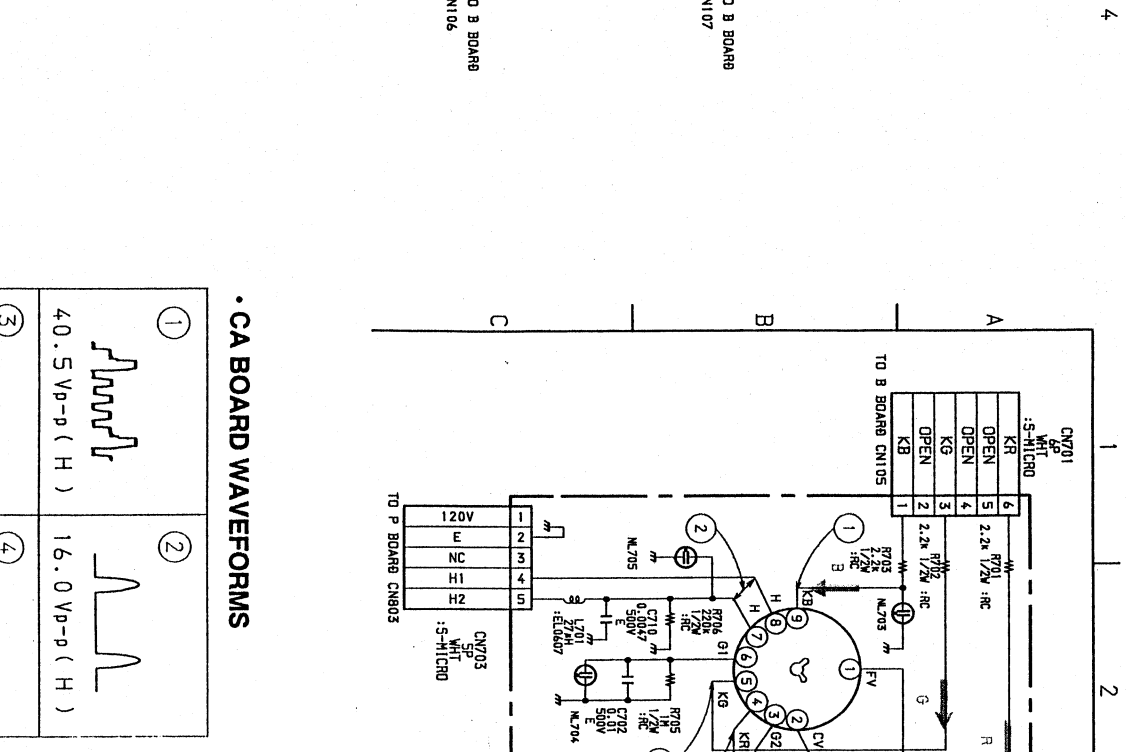
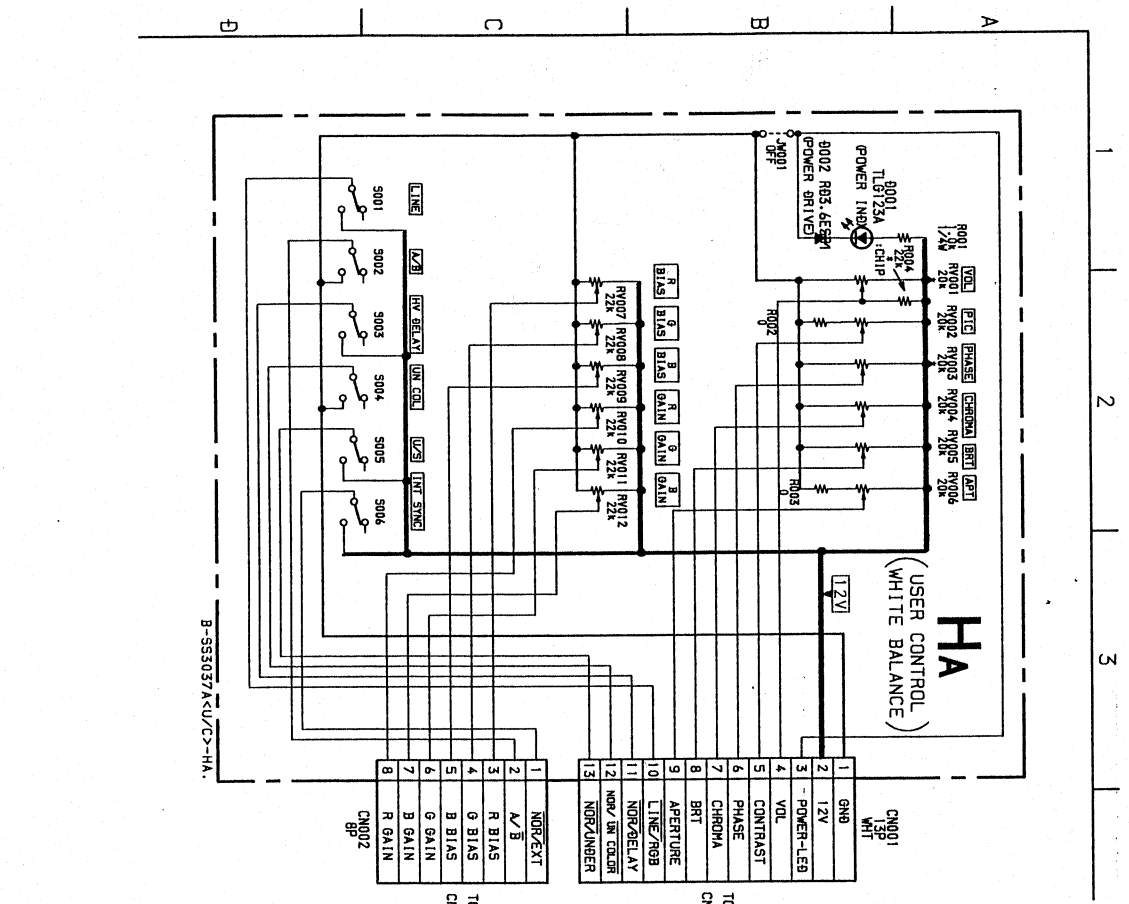
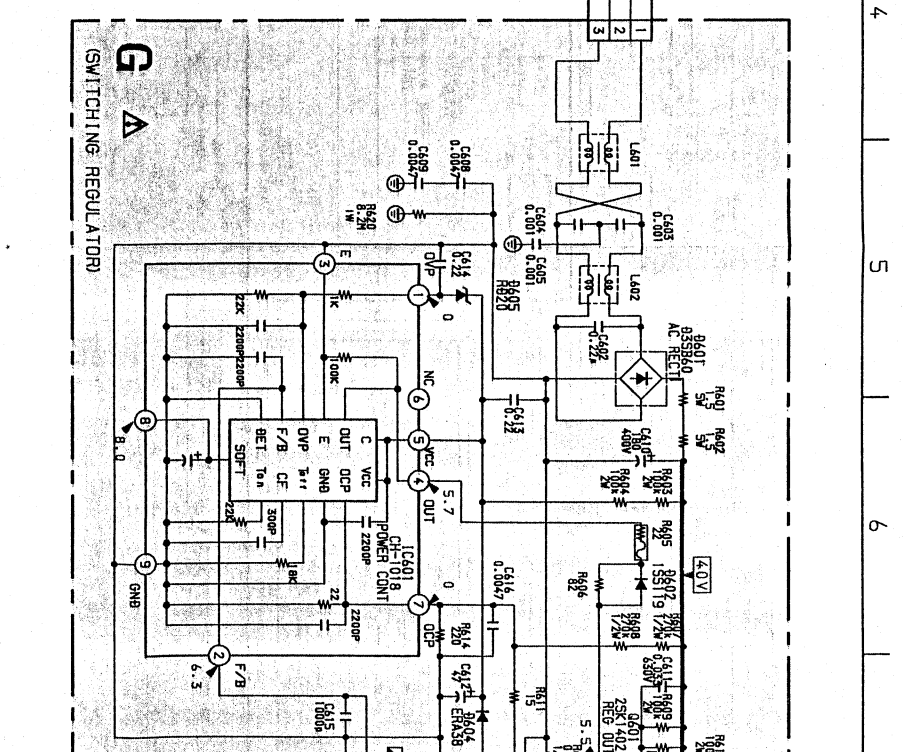
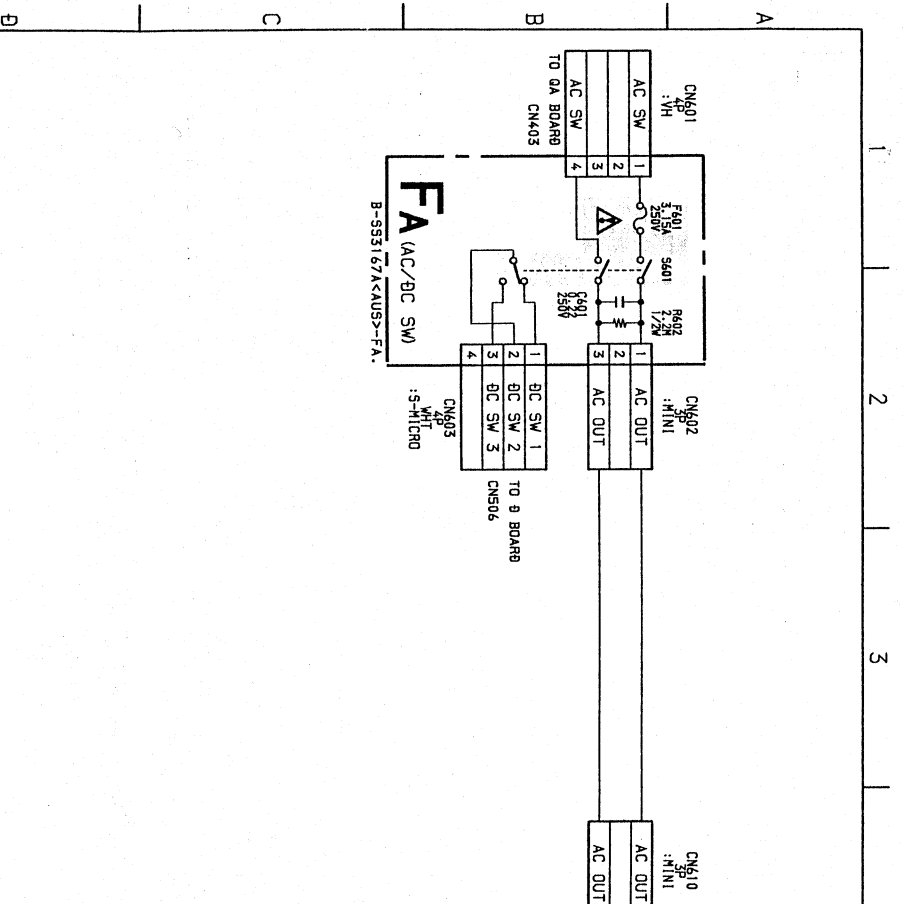

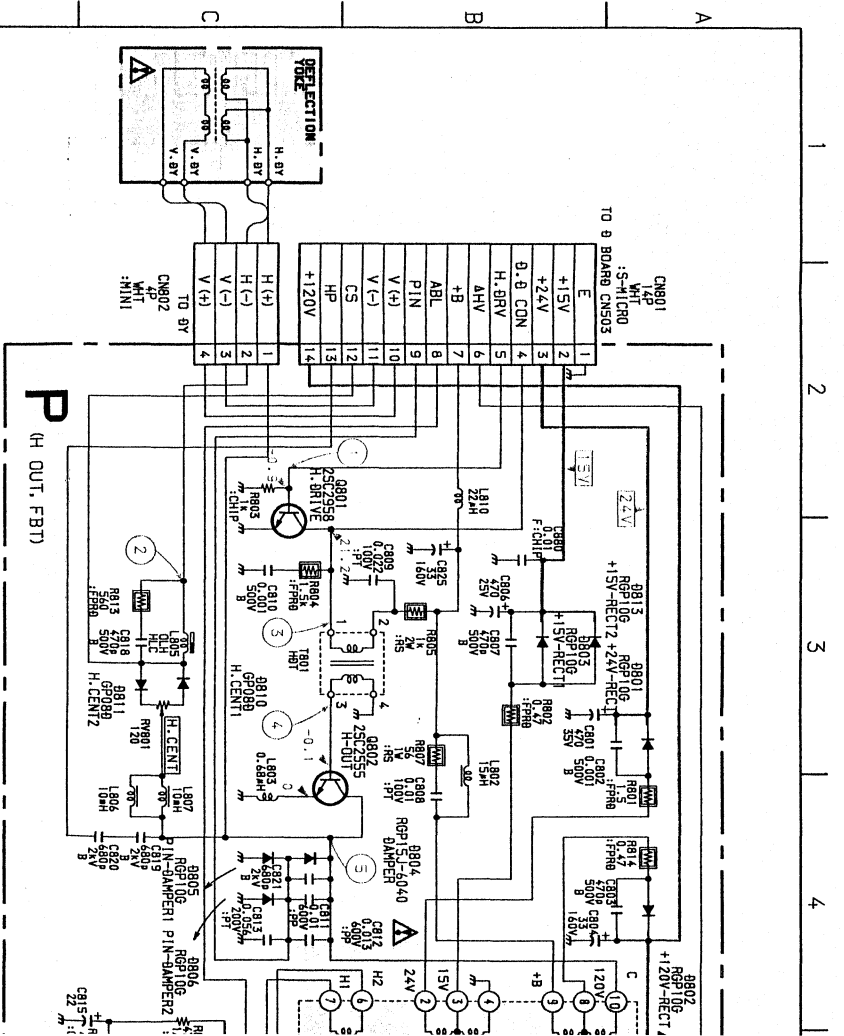
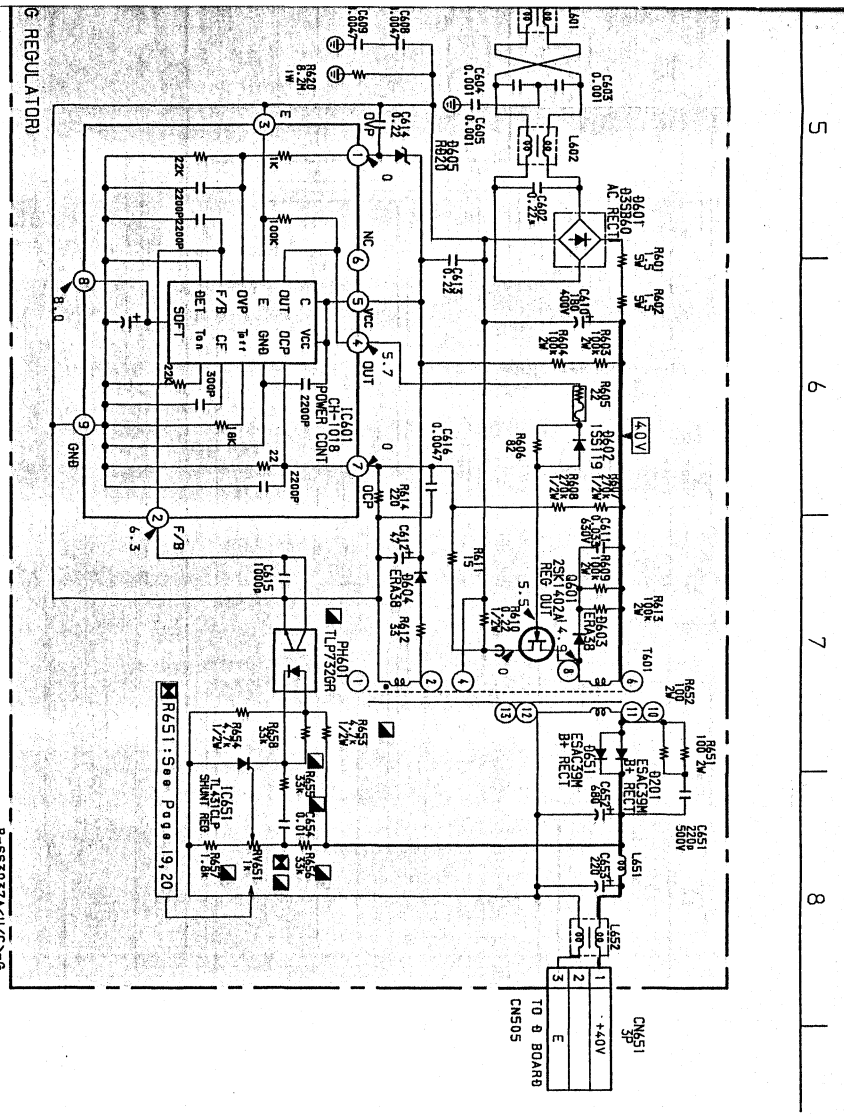

• P BOARD WAVEFORMS

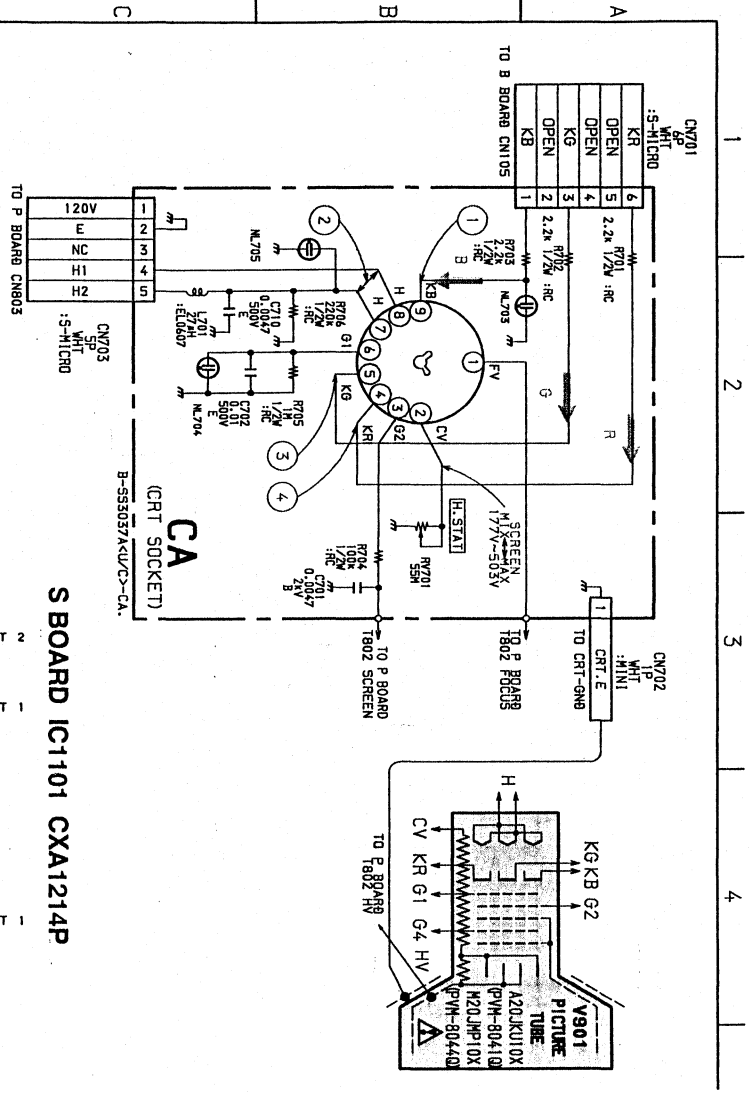
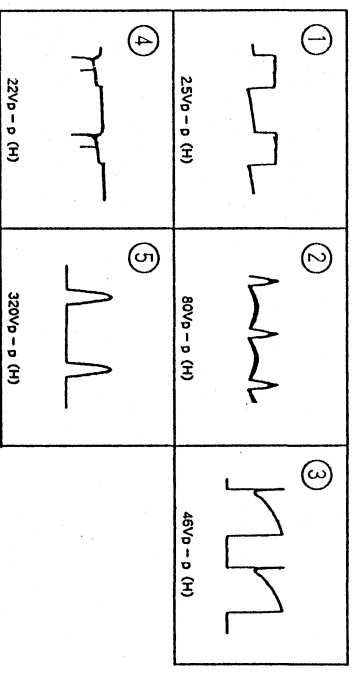

S BOARD IC1101 CXA1214P

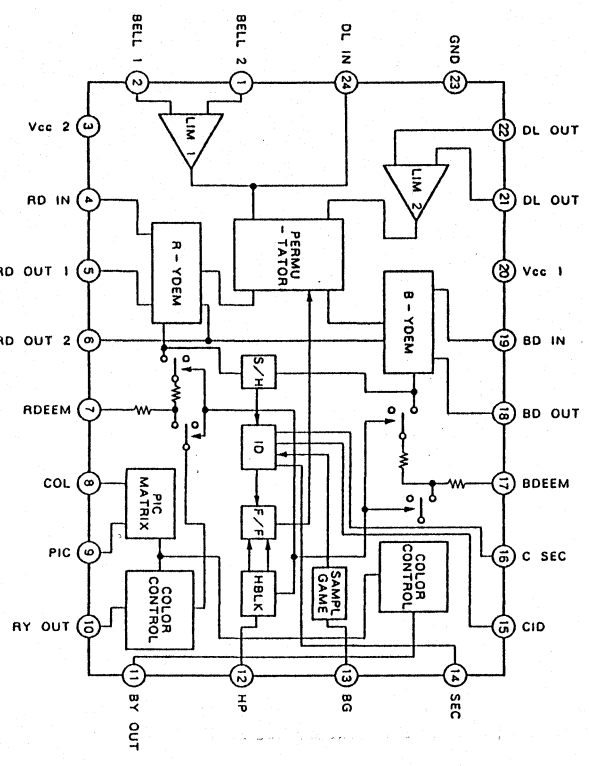

• CA BOARD WAVEFORMS

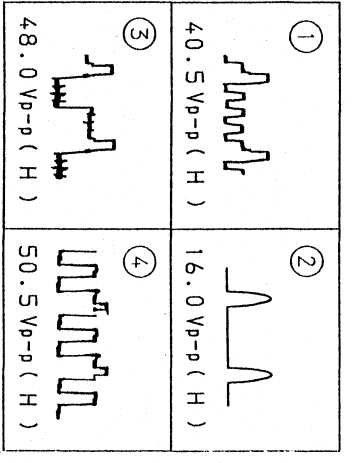

• S BOARD WAVEFORMS

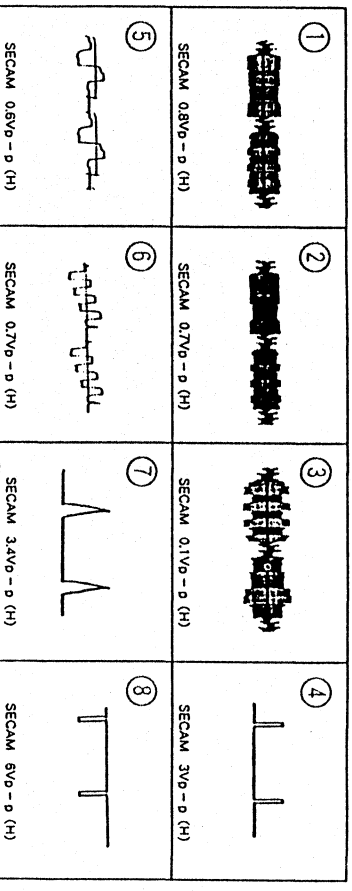

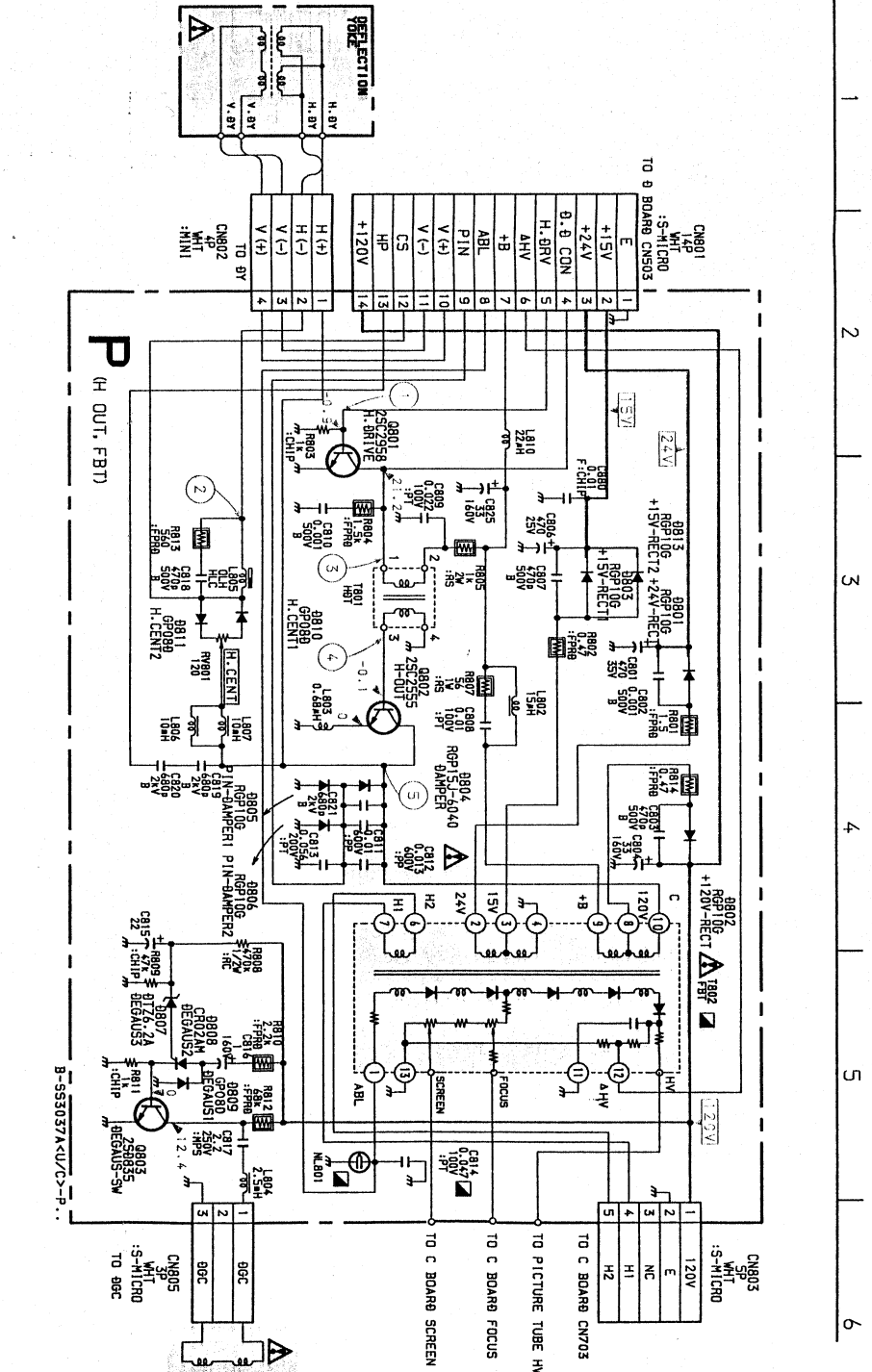
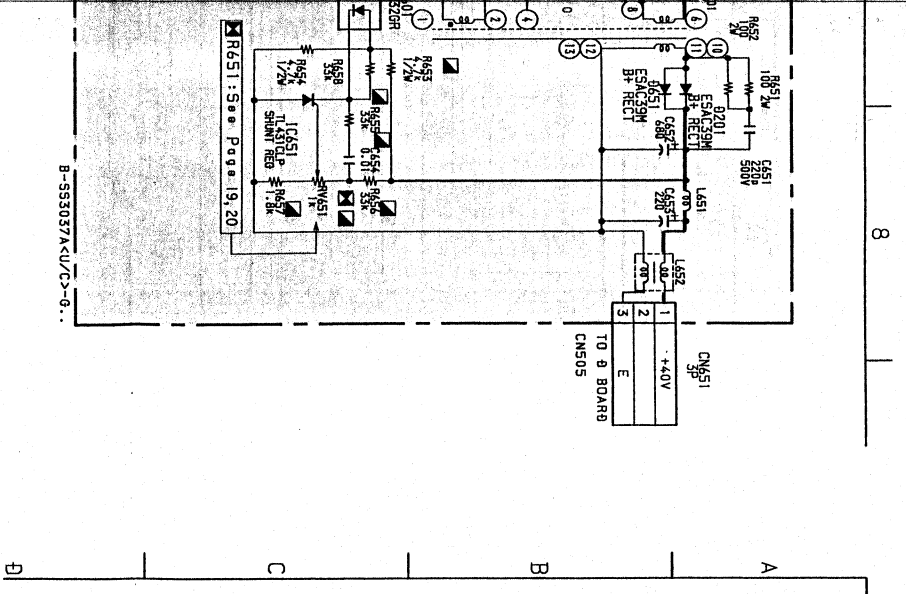

• P BOARD WAVEFORMS

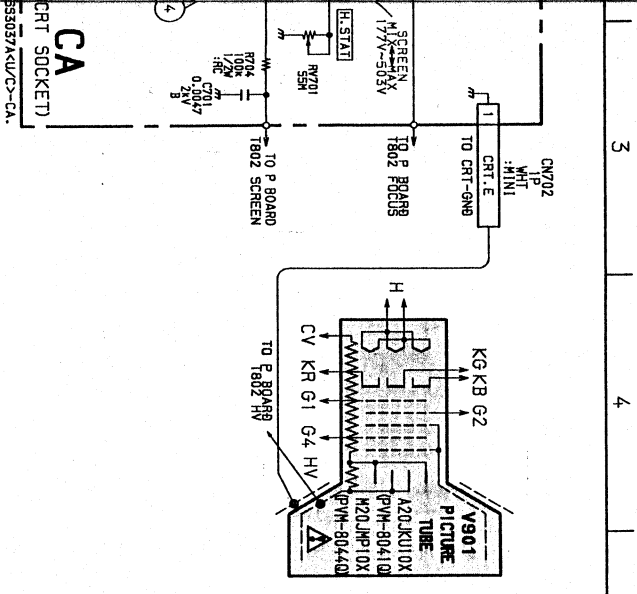
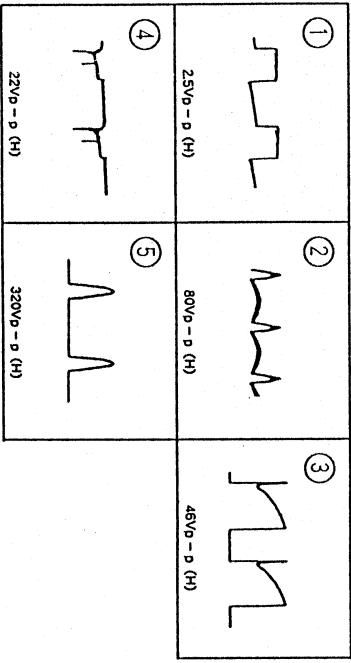

S BOARD IC101 CXA1214P

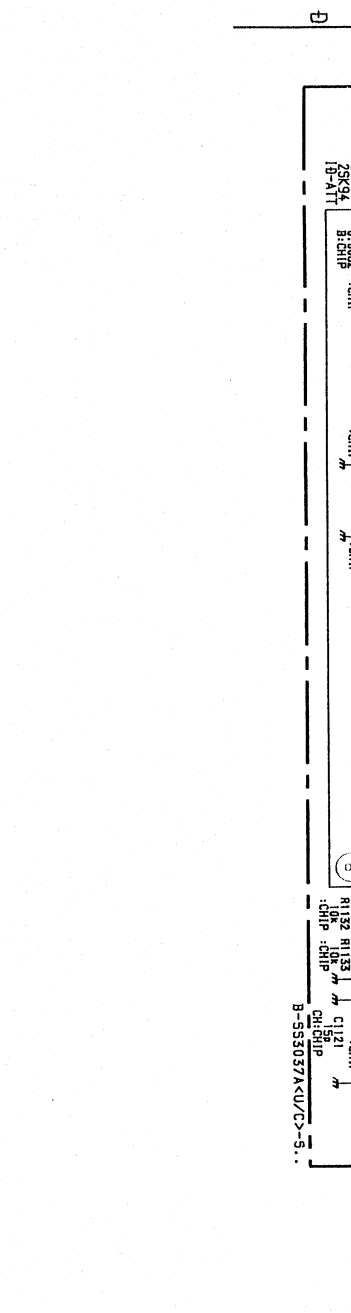
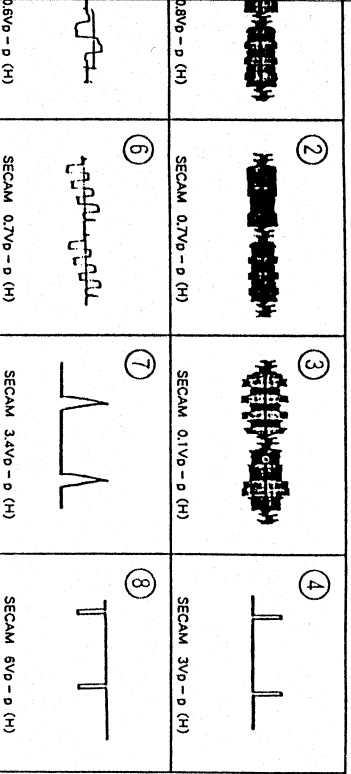
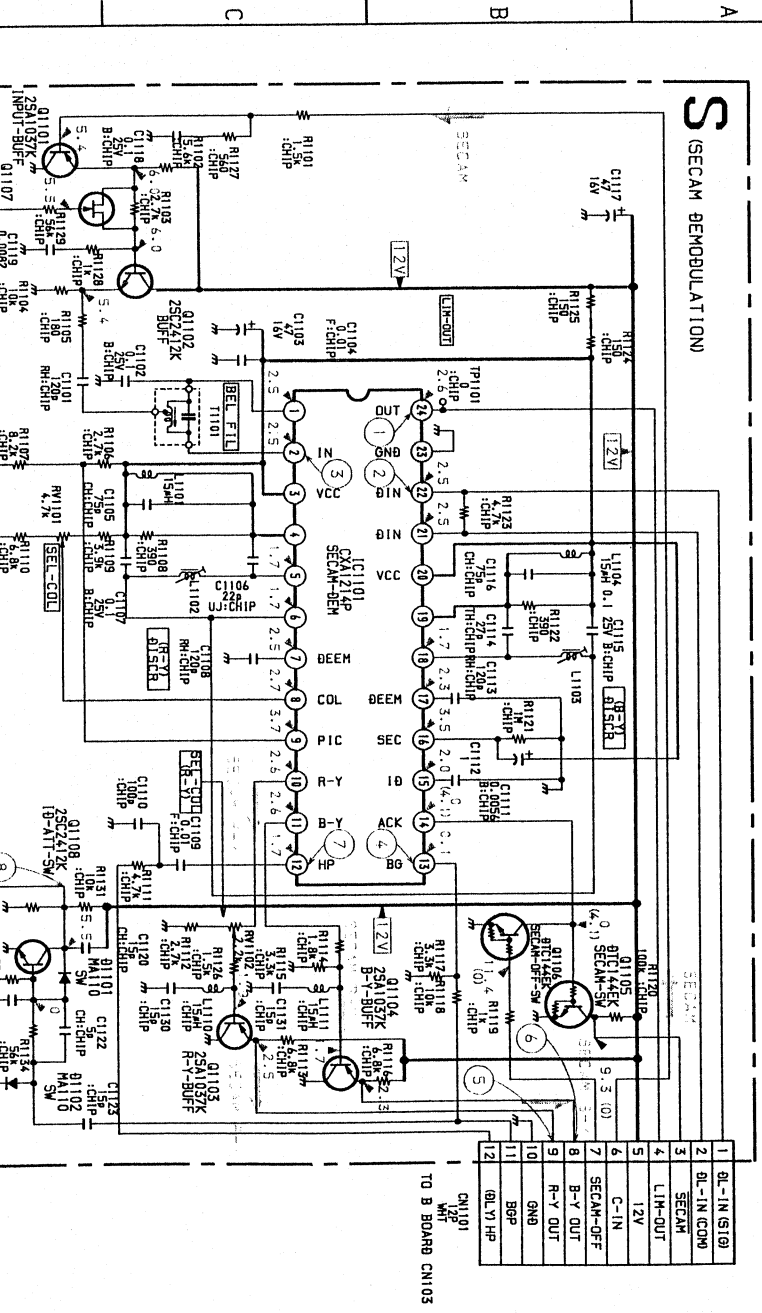
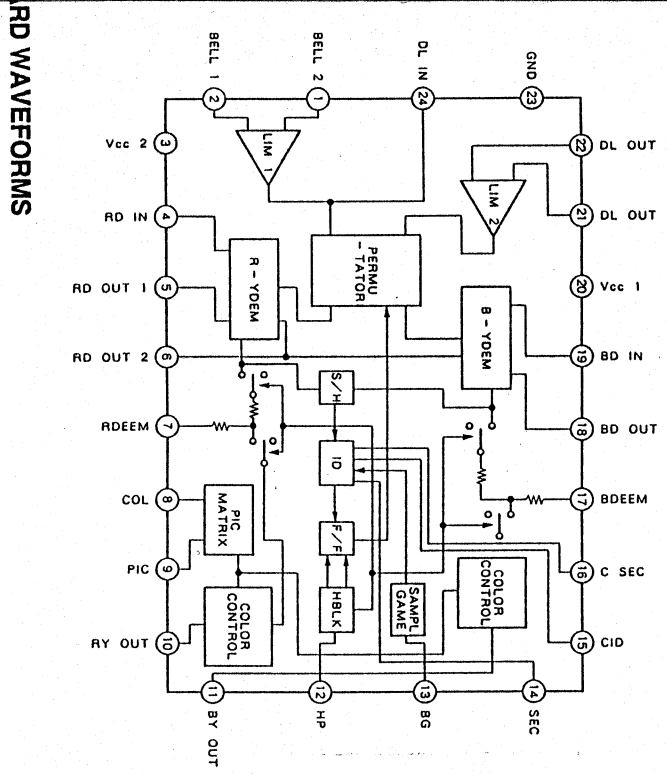

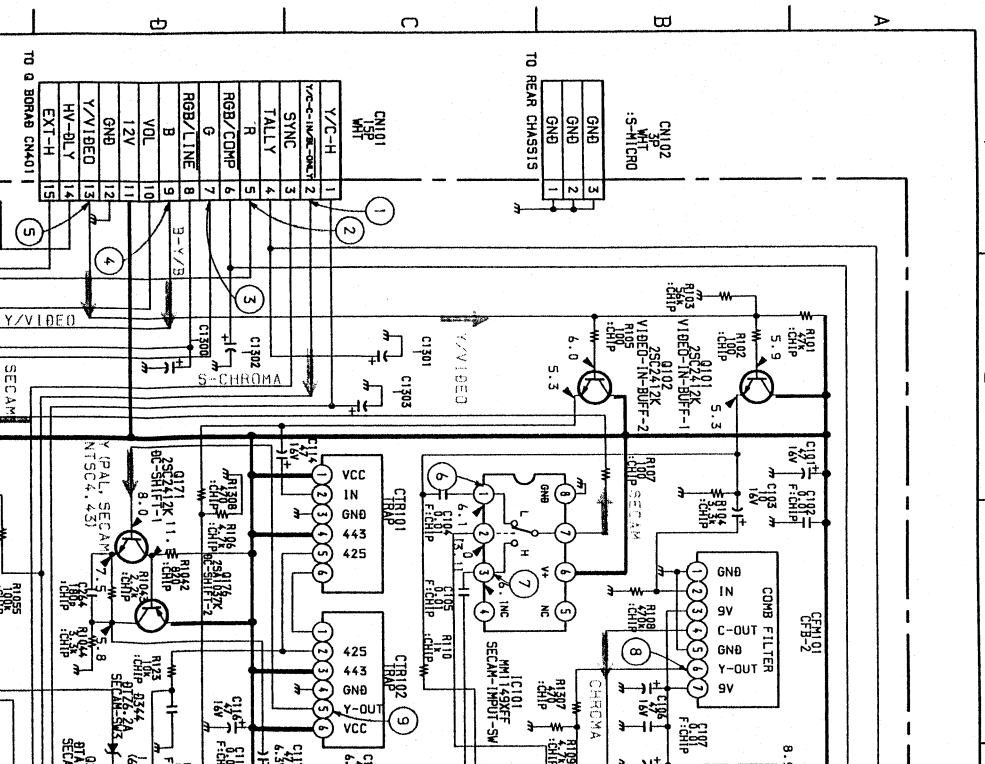

B BOARD
As to the voltage value shown by the mark * on the Schematic Diagram, see another list.

< TRANSISTOR >

Q	PAL	SECAM	NTSC	NTSC	S (V/C)	ANALOG	COMP.
		3.58	4.43		RGB	MENT	
Q113	E	0.5	0.4	0.4	0.5	0.5	0.5
Q114	B	1.0	1.0	0.9	0.9	0.9	1.0
Q115	E	11.2	9.3	0.0	10.6	0.0	0.0
Q116	B	2.8	2.2	0.1	2.4	0.1	0.0
Q117	E	0.0	0.0	1.7	1.7	1.7	1.7
Q118	B	0.1	0.0	1.7	1.7	1.7	1.7
Q119	E	0.0	0.0	1.7	1.7	1.7	1.7
Q120	B	0.0	0.0	1.7	1.7	1.7	1.7
Q121	E	0.0	0.0	1.7	1.7	1.7	1.7
Q122	B	0.0	0.0	1.7	1.7	1.7	1.7
Q123	E	2.2	2.3	2.4	2.3	2.4	2.4
Q124	C	1.8	1.7	1.7	1.7	1.8	1.8
Q125	B	2.7	2.6	2.8	2.7	2.8	2.8
Q126	E	11.7	11.6	11.4	11.5	11.4	11.4
Q127	C	126.0	123.5	123.4	123.8	124.6	124.4
Q128	B	119.8	119.5	118.4	118.2	114.2	114.2
Q129	E	86.1	84.9	81.2	83.4	82.5	82.2
Q130	B	94.0	93.3	89.3	92.4	94.2	90.8
Q131	E	1.6	1.6	1.4	1.7	1.7	1.7
Q132	C	86.1	84.9	81.2	83.4	82.5	82.2
Q133	E	90.7	91.4	98.0	87.0	86.5	86.4
Q134	C	89.2	89.8	86.5	88.4	84.9	84.7
Q135	B	82.1	82.7	100.2	88.5	92.4	90.5
Q136	E	80.1	80.0	82.8	82.0	82.0	82.7
Q137	C	10.8	10.5	9.7	10.9	10.9	11.0
Q138	B	82.5	82.9	80.8	80.1	88.7	80.4
Q139	E	88.3	88.5	95.7	85.7	83.0	84.0
Q140	B	82.4	81.1	87.5	79.9	80.8	78.4
Q141	E	80.0	84.8	91.2	84.4	82.7	82.5
Q142	B	80.0	84.8	91.2	84.4	82.7	82.5
Q143	E	1.8	1.5	1.3	1.6	1.6	1.7
Q144	B	2.1	2.0	1.8	2.1	2.2	2.2
Q145	E	1.6	1.6	1.3	1.6	1.7	1.7
Q146	B	2.2	2.1	1.5	2.1	2.2	2.2
Q147	E	0.2	0.6	2.7	0.5	-0.5	-0.6
Q148	B	0.9	0.9	0.6	1.0	1.0	1.0
Q149	E	0.9	0.9	0.6	1.0	1.0	1.0
Q150	B	2.1	2.0	1.8	2.1	2.2	2.2
Q151	E	1.6	1.6	1.3	1.6	1.7	1.7
Q152	B	2.2	2.1	1.5	2.1	2.2	2.2
Q153	E	0.2	0.6	2.7	0.5	-0.5	-0.6
Q154	B	0.9	0.9	0.6	1.0	1.0	1.0
Q155	E	0.9	0.9	0.6	1.0	1.0	1.0
Q156	B	2.1	2.0	1.8	2.1	2.2	2.2
Q157	E	1.6	1.6	1.3	1.6	1.7	1.7
Q158	B	2.2	2.1	1.5	2.1	2.2	2.2
Q159	E	0.2	0.6	2.7	0.5	-0.5	-0.6
Q160	B	0.9	0.9	0.6	1.0	1.0	1.0
Q161	E	0.9	0.9	0.6	1.0	1.0	1.0
Q162	B	2.1	2.0	1.8	2.1	2.2	2.2
Q163	E	1.6	1.6	1.3	1.6	1.7	1.7
Q164	B	2.2	2.1	1.5	2.1	2.2	2.2
Q165	E	0.2	0.6	2.7	0.5	-0.5	-0.6
Q166	B	0.9	0.9	0.6	1.0	1.0	1.0
Q167	E	0.9	0.9	0.6	1.0	1.0	1.0
Q168	B	2.1	2.0	1.8	2.1	2.2	2.2
Q169	E	1.6	1.6	1.3	1.6	1.7	1.7
Q170	B	2.2	2.1	1.5	2.1	2.2	2.2
Q171	E	0.2	0.6	2.7	0.5	-0.5	-0.6
Q172	B	0.9	0.9	0.6	1.0	1.0	1.0
Q173	E	0.9	0.9	0.6	1.0	1.0	1.0
Q174	B	2.1	2.0	1.8	2.1	2.2	2.2
Q175	E	1.6	1.6	1.3	1.6	1.7	1.7
Q176	B	2.2	2.1	1.5	2.1	2.2	2.2
Q177	E	0.2	0.6	2.7	0.5	-0.5	-0.6
Q178	B	0.9	0.9	0.6	1.0	1.0	1.0
Q179	E	0.9	0.9	0.6	1.0	1.0	1.0
Q180	B	2.1	2.0	1.8	2.1	2.2	2.2
Q181	E	1.6	1.6	1.3	1.6	1.7	1.7
Q182	B	2.2	2.1	1.5	2.1	2.2	2.2
Q183	E	0.2	0.6	2.7	0.5	-0.5	-0.6
Q184	B	0.9	0.9	0.6	1.0	1.0	1.0
Q185	E	0.9	0.9	0.6	1.0	1.0	1.0
Q186	B	2.1	2.0	1.8	2.1	2.2	2.2
Q187	E	1.6	1.6	1.3	1.6	1.7	1.7
Q188	B	2.2	2.1	1.5	2.1	2.2	2.2
Q189	E	0.2	0.6	2.7	0.5	-0.5	-0.6
Q190	B	0.9	0.9	0.6	1.0	1.0	1.0
Q191	E	0.9	0.9	0.6	1.0	1.0	1.0
Q192	B	2.1	2.0	1.8	2.1	2.2	2.2
Q193	E	1.6	1.6	1.3	1.6	1.7	1.7
Q194	B	2.2	2.1	1.5	2.1	2.2	2.2
Q195	E	0.2	0.6	2.7	0.5	-0.5	-0.6
Q196	B	0.9	0.9	0.6	1.0	1.0	1.0
Q197	E	0.9	0.9	0.6	1.0	1.0	1.0
Q198	B	2.1	2.0	1.8	2.1	2.2	2.2
Q199	E	1.6	1.6	1.3	1.6	1.7	1.7
Q200	B	2.2	2.1	1.5	2.1	2.2	2.2
Q201	E	0.2	0.6	2.7	0.5	-0.5	-0.6
Q202	B	0.9	0.9	0.6	1.0	1.0	1.0
Q203	E	0.9	0.9	0.6	1.0	1.0	1.0
Q204	B	2.1	2.0	1.8	2.1	2.2	2.2
Q205	E	1.6	1.6	1.3	1.6	1.7	1.7
Q206	B	2.2	2.1	1.5	2.1	2.2	2.2
Q207	E	0.2	0.6	2.7	0.5	-0.5	-0.6
Q208	B	0.9	0.9	0.6	1.0	1.0	1.0
Q209	E	0.9	0.9	0.6	1.0	1.0	1.0
Q210	B	2.1	2.0	1.8	2.1	2.2	2.2
Q211	C	115.0	113.6	111.7	113.9	113.8	114.3

< IC >

	PAL	SECAM	NTSC	NTSC	S (V/C)	ANALOG	COMP.
		3.58	4.43		RGB	MENT	
IC102	①	8.6	8.6	0.0	6.6	0.0	0.0
IC103	②	0.2	0.1	0.1	0.1	0.1	0.2
IC104	③	1.8	1.7	1.7	1.7	1.8	1.8
IC105	④	10.7	10.7	10.6	10.6	10.6	10.6
IC106	⑤	1.2	10.7	0.0	0.0	0.0	0.0
IC107	⑥	8.7	0.4	9.7	9.6	9.6	1.1
IC108	⑦	11.3	11.3	0.0	10.8	0.0	0.0
IC109	⑧	11.3	11.4	0.0	11.3	0.0	0.0
IC110	⑨	11.7	0.0	0.0	11.7	0.0	0.0
IC111	⑩	2.1	2.2	2.5	2.5	2.5	2.5
IC112	⑪	11.3	11.3	0.0	11.3	0.0	0.0
IC113	⑫	0.8	0.8	0.0	0.0	0.0	0.0
IC114	⑬	1.7	1.7	2.5	2.6	2.5	2.5
IC115	⑭	2.7	1.1	2.6	2.6	2.6	1.1
IC116	⑮	4.2	4.3	4.2	4.3	4.3	4.8
IC117	⑯	3.0	2.9	2.8	3.0	2.8	2.8
IC118	⑰	2.2	2.5	2.9	2.2	1.9	2.8
IC119	⑱	11.4	11.3	0.0	0.0	0.0	0.0
IC120	⑲	3.7	3.7	3.8	3.8	3.8	3.9
IC121	⑳	1.2	1.1	0.8	0.7	0.7	0.8
IC122	㉑	3.5	3.5	3.4	2.8	3.4	3.4
IC123	㉒	0.0	0.0	1.0	1.1	1.1	1.1
IC124	㉓	5.5	5.8	5.8	5.8	5.8	5.8
IC125	㉔	5.5	5.8	5.8	5.8	5.8	5.8
IC126	㉕	5.5	5.8	5.8	5.8	5.8	5.8
IC127	㉖	5.5	5.8	5.8	5.8	5.8	5.8
IC128	㉗	5.3	5.3	5.4	5.2	5.2	5.1
IC129	㉘	0.1	0.1	0.2	0.2	0.2	0.2
IC130	㉙	1.4	1.4	1.3	1.4	1.5	1.5
IC131	㉚	1.8	1.5	1.3	1.8	1.8	1.7
IC132	㉛	1.7	1.6	1.4	1.7	1.7	1.8
IC133	㉜	3.0	2.8	2.6	3.0	3.1	3.0
IC134	㉝	1.4	1.4	1.3	1.5	1.5	1.5
IC135	㉞	2.1	2.7	2.4	2.8	2.8	2.8

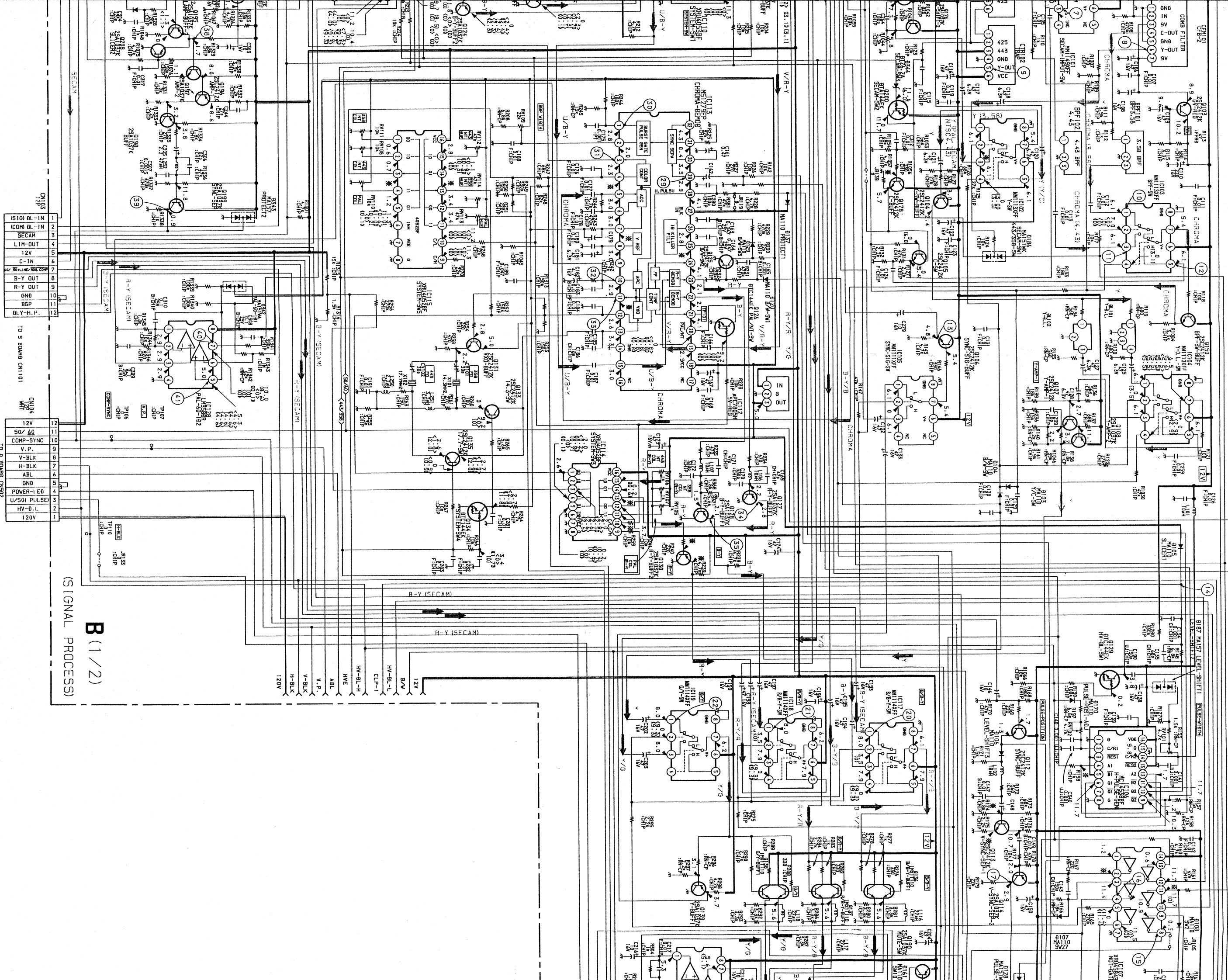

B (1/2)

(SIGNAL PROCESS)

CN103	1	(S10) DL-IN
	2	COM DL-IN
	3	SECAM
	4	LIM-OUT
	5	12V
	6	C-IN
	7	50-HLINE/RGB COMP
	8	B-Y OUT
	9	R-Y OUT
	10	GNB
	11	BGP
	12	BLY-H.P.

TO S BOARD CN101

CN104	1	12V
	2	50/60
	3	COMP-SYNC
	4	V.P.
	5	V-BLK
	6	H-BLK
	7	GNB
	8	POWER-LED
	9	USH PULSE
	10	HV-D.L
	11	120V

TO B BOARD CN202

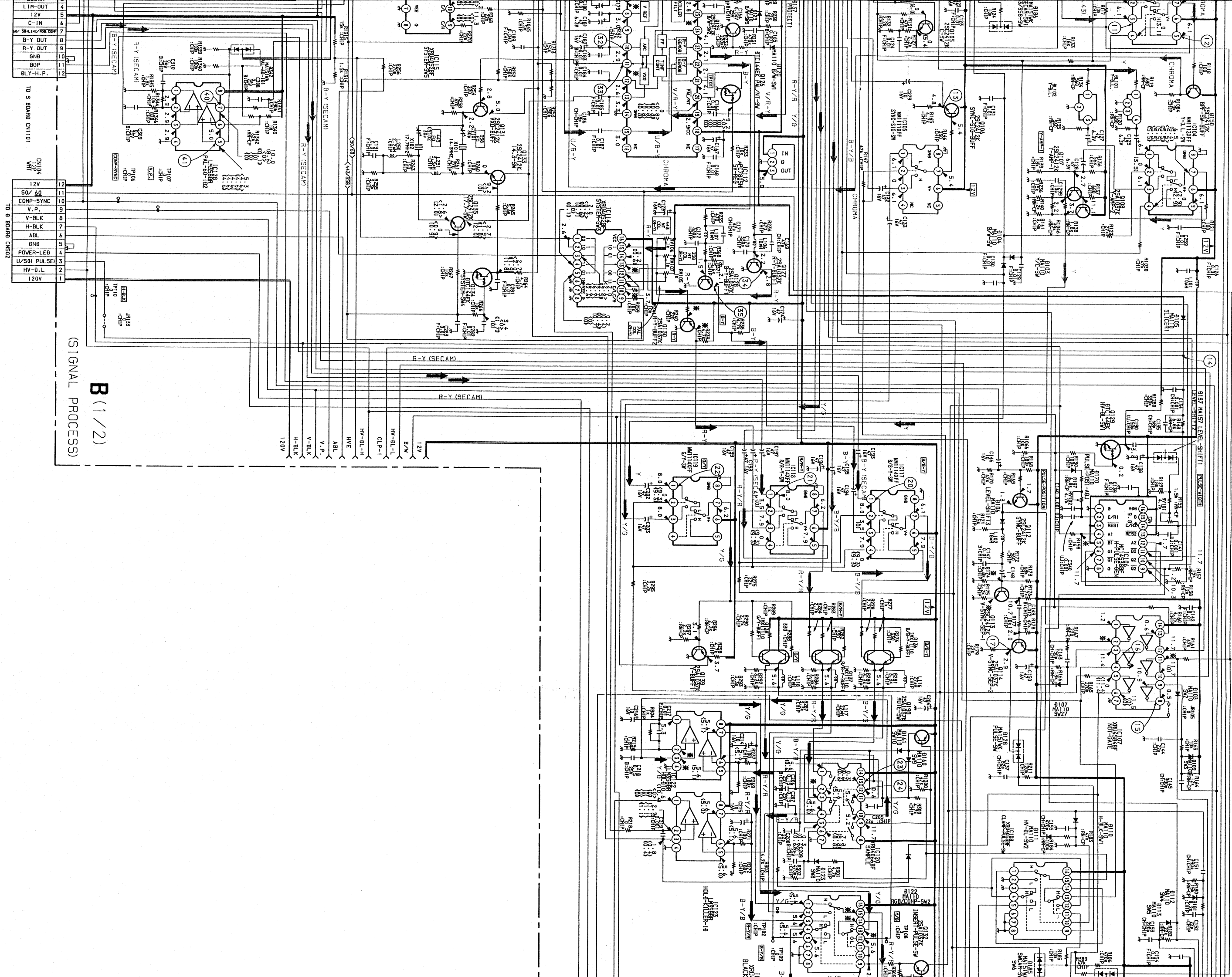

B (1/2)
(SIGNAL PROCESS)

12V	4
LIM-OUT	5
C-IN	6
B-Y OUT	7
R-Y OUT	8
GND	9
BGP	10
BLY-H.P.	11
	12

12V	12
50/60	11
COMP-SYNC	10
V.P.	9
V-BLK	8
H-BLK	7
ABL	6
GND	5
POWER-LED	4
U/SH PULSE	3
HV-D.L	2
120V	1

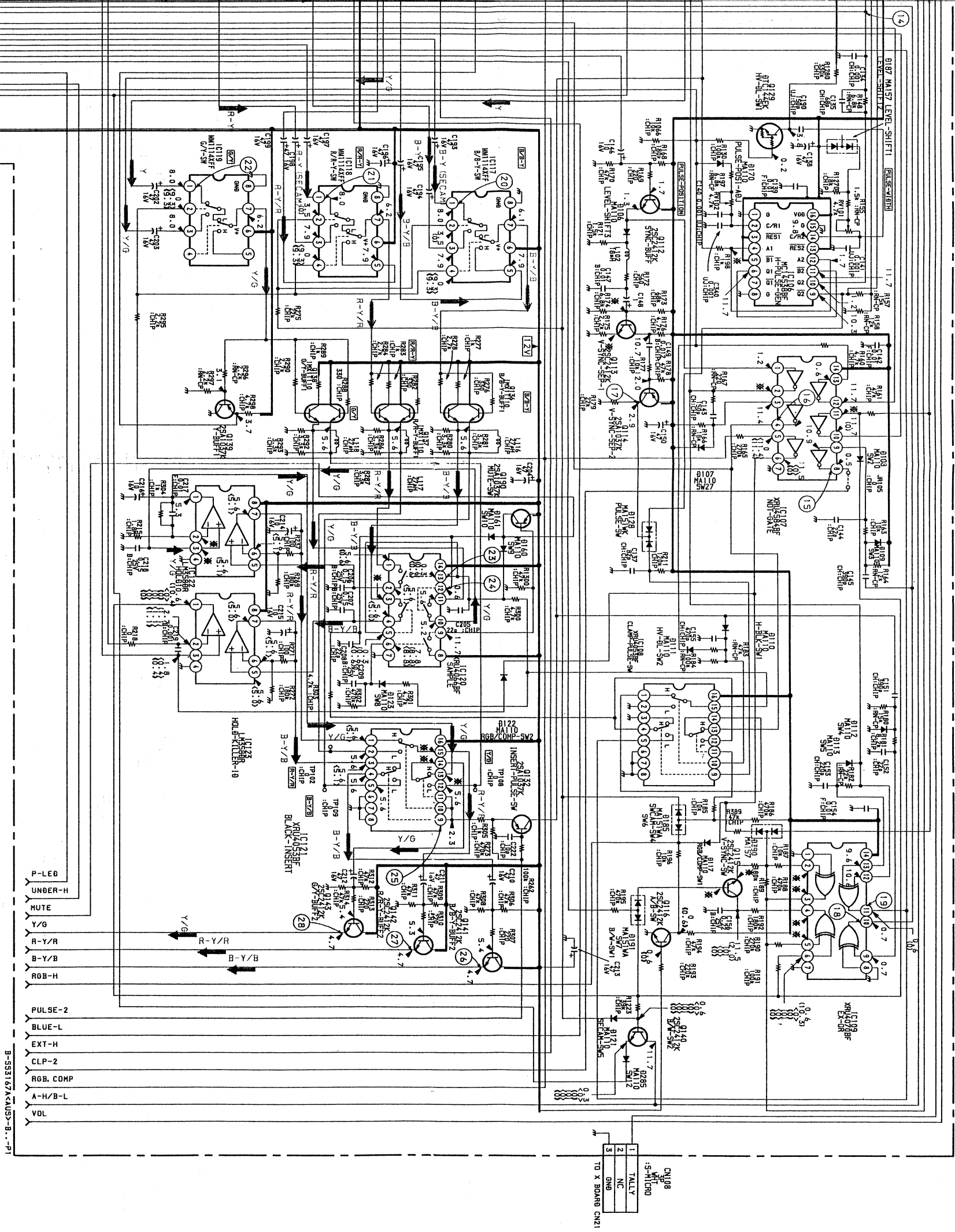

B (1/2)
 SIGNAL PROCESS

B(2/2)
(SIGNAL PROCESS)

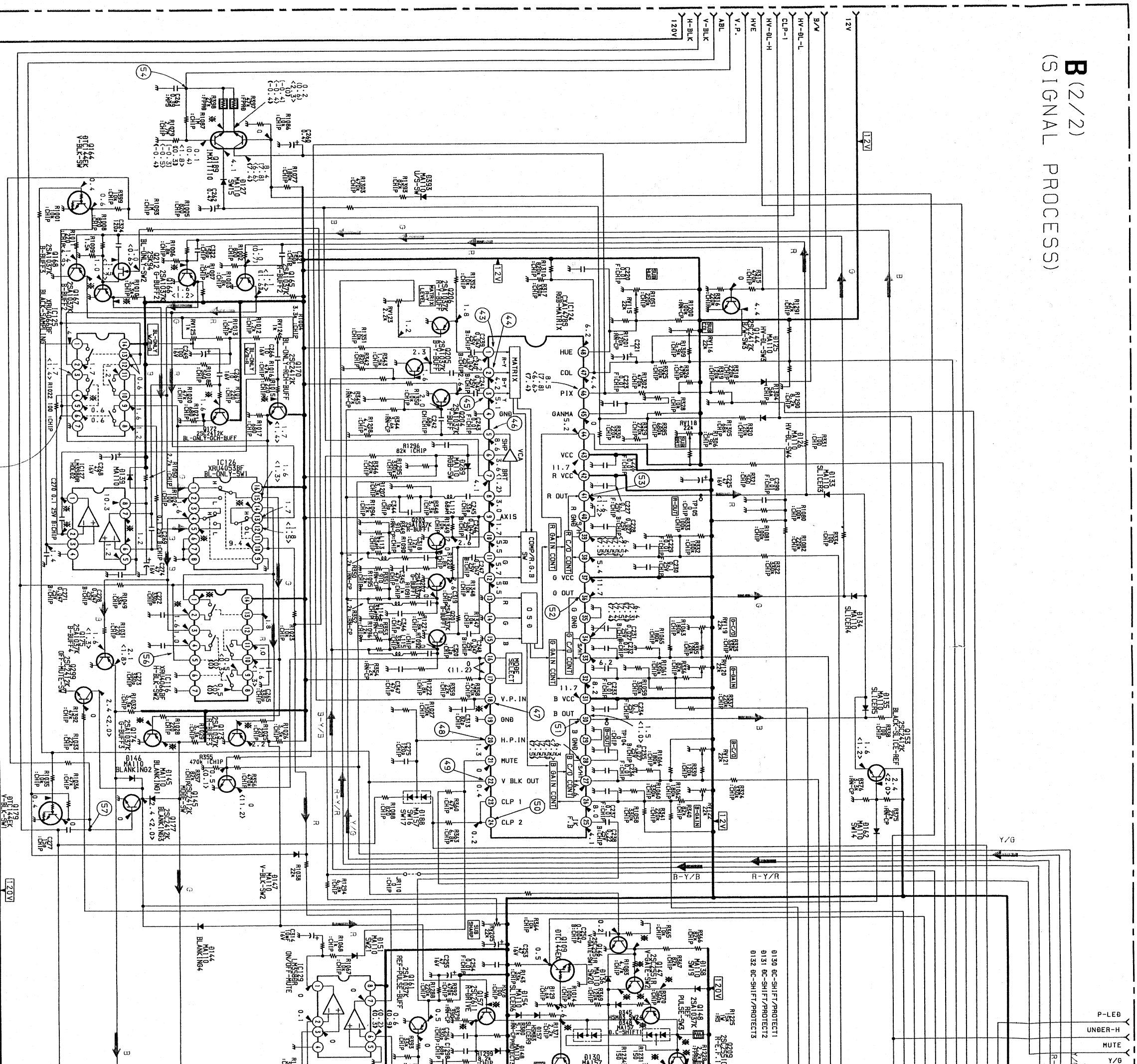

- 0130 GC-SHIFT/PROTECT1
- 0131 GC-SHIFT/PROTECT2
- 0132 GC-SHIFT/PROTECT3

P-LED
UNBER-H
MUTE
V/V

• B BOARD WAVEFORMS

1		2		3		4	
5		6		7		8	
9		10		11		12	
13		14		15		16	
17		18		19		20	
21		22		23		24	
25		26		27		28	
29		30		31		32	
33		34		35		36	
37		38		39		40	
41		42		43		44	
45		46		47		48	
49		50		51		52	
53		54		55		56	
57		58		59		60	

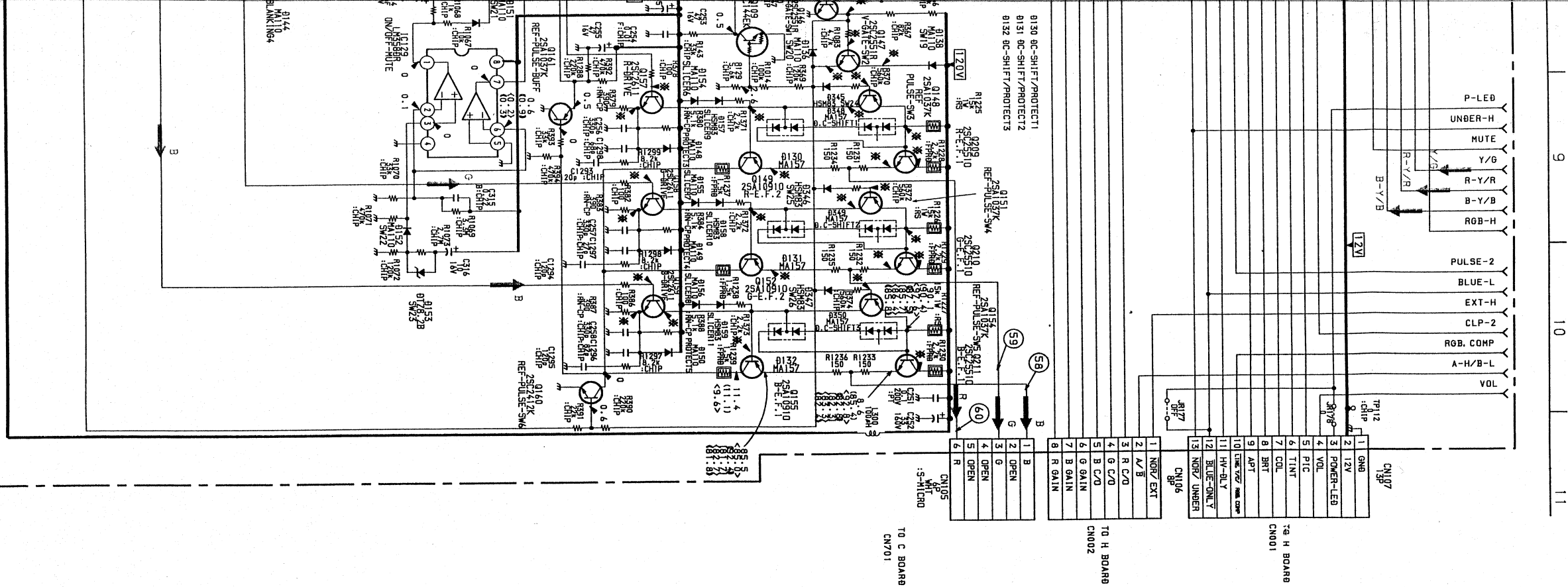





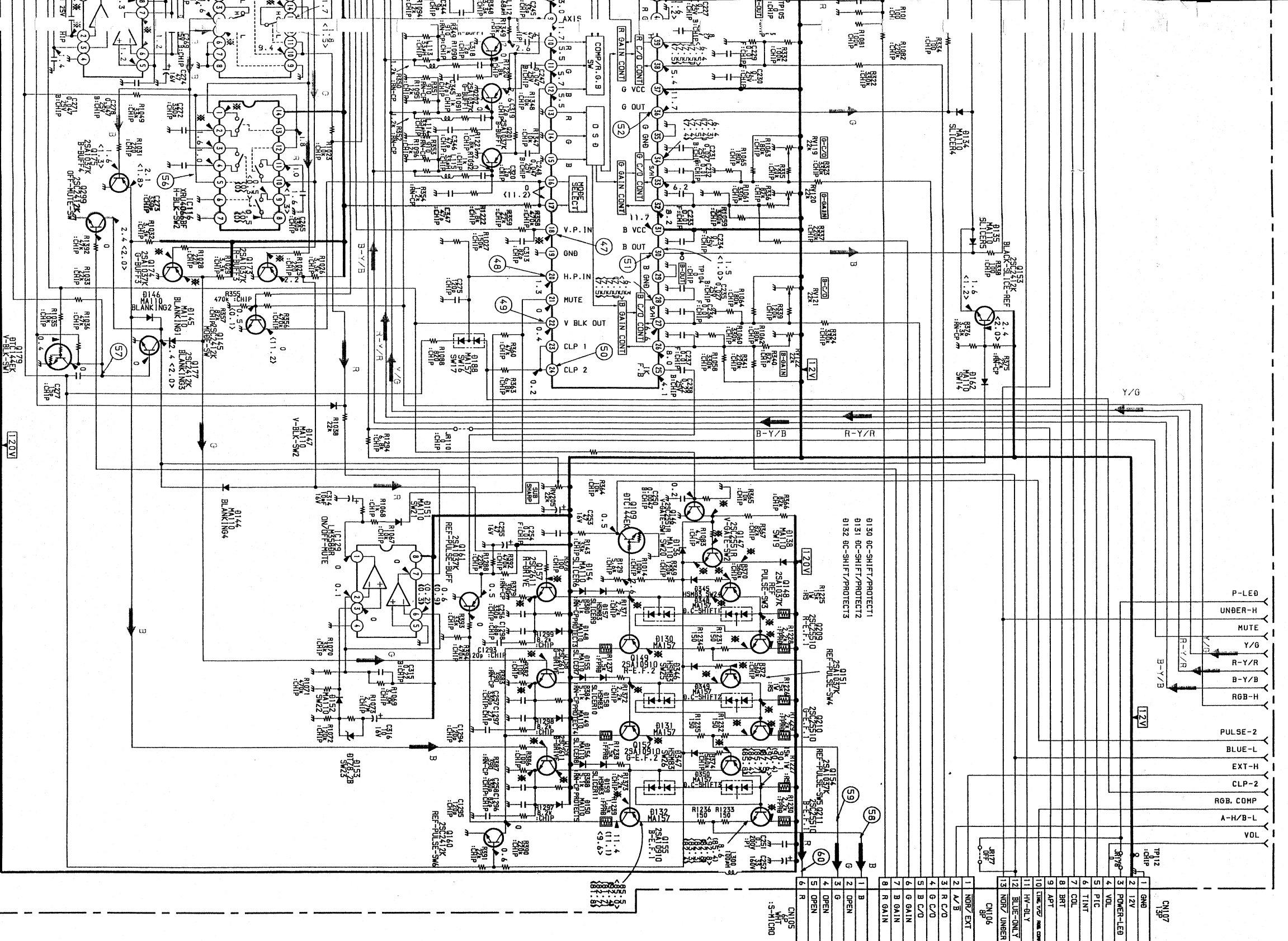



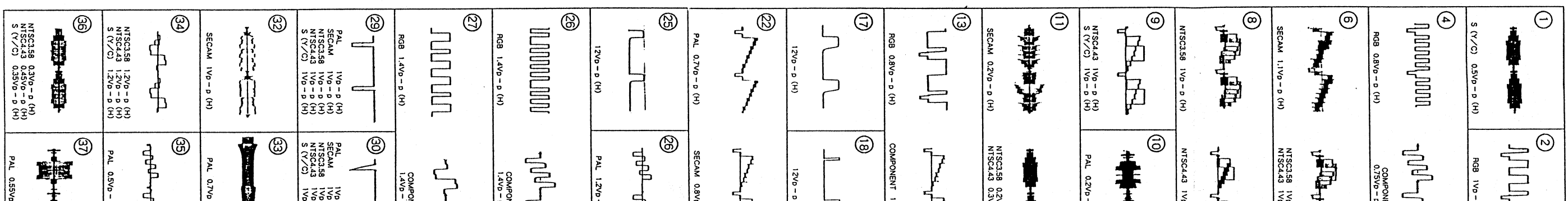

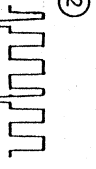
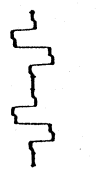
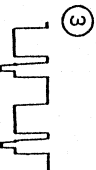
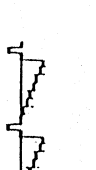
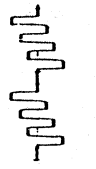
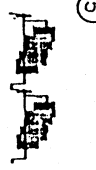
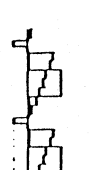
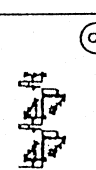
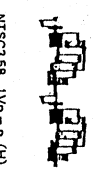
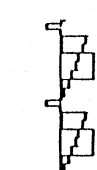

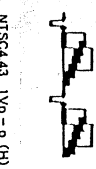
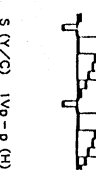
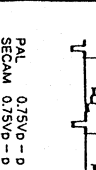
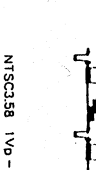
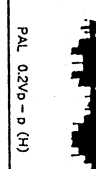
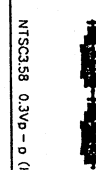
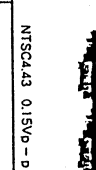
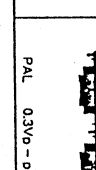
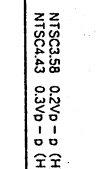
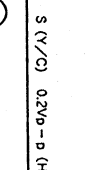
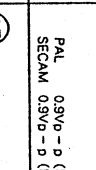
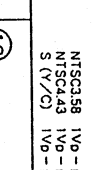
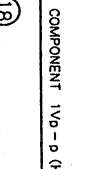
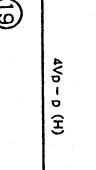
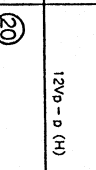
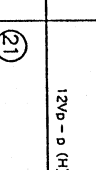
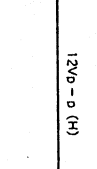
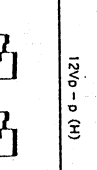
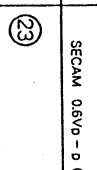
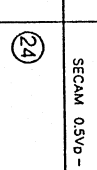
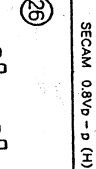
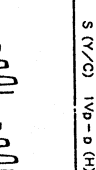
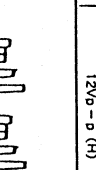
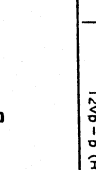
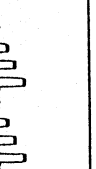
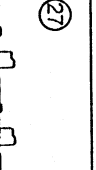

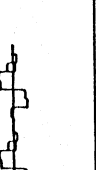
9 10 11

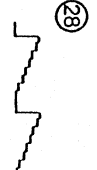
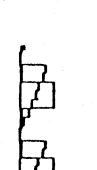
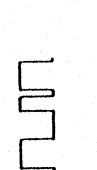
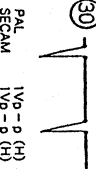





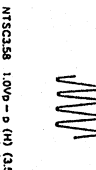
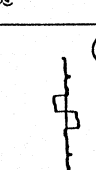
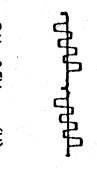
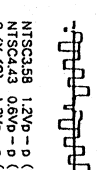
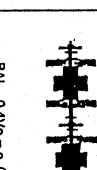
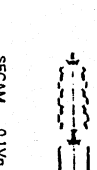

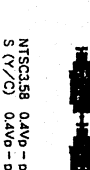
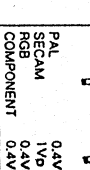
5 6 7 8 9 10 11

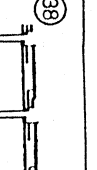
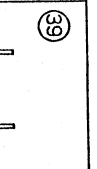
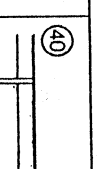
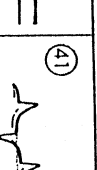
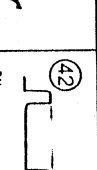
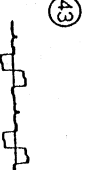

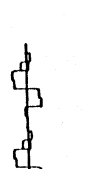
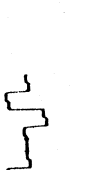
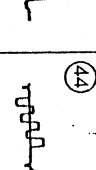
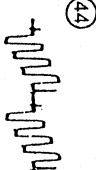
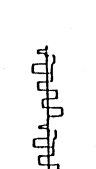
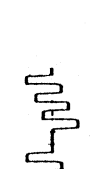
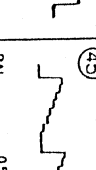
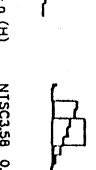
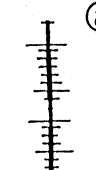
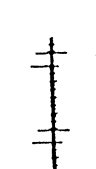
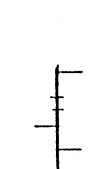
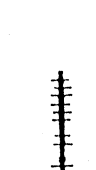
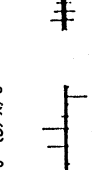
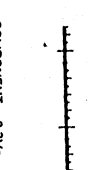
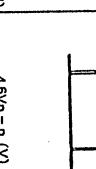
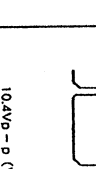
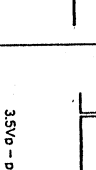
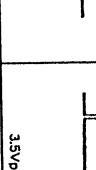
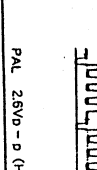
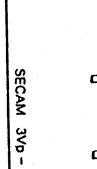
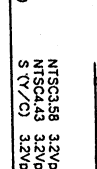
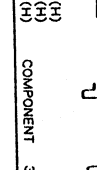
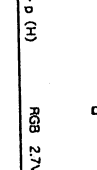
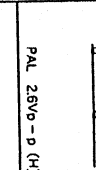
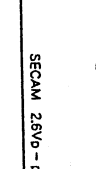
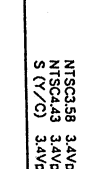
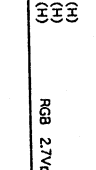
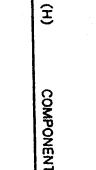
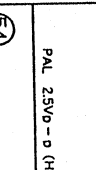
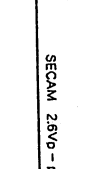
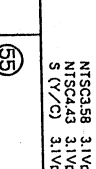
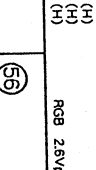
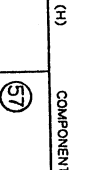
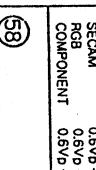
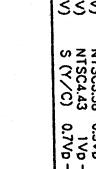
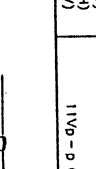
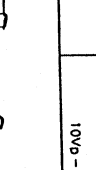
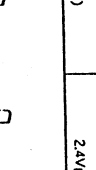
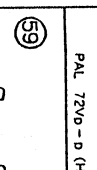
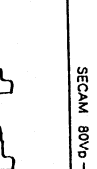
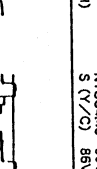
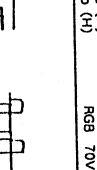
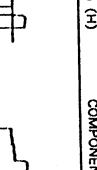
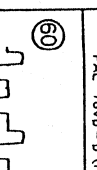
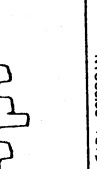
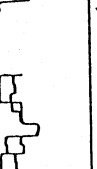
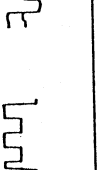
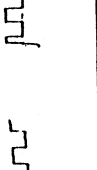
• BOARD WAVEFORMS



 RGB 1V ₀ -D (H)	 COMPONENT 0.5V ₀ -D (H)	 RGB 1V ₀ -D (H)	 COMPONENT 1V ₀ -D (H)
 COMPONENT 0.75V ₀ -D (H)	 PAL 1V ₀ -D (H)	 S (Y/C) 1V ₀ -D (H)	 PAL 0.9V ₀ -D (H)
 NTSC358 1V ₀ -D (H) NTSC443 1V ₀ -D (H)	 S (Y/C) 1V ₀ -D (H)	 S (Y/C) 0.5V ₀ -D (H)	 SECAM 1V ₀ -D (H)
 NTSC443 1V ₀ -D (H)	 S (Y/C) 1V ₀ -D (H)	 PAL 0.75V ₀ -D (H) SECAM 0.75V ₀ -D (H)	 NTSC358 1V ₀ -D (H)
 PAL 0.2V ₀ -D (H)	 NTSC358 0.3V ₀ -D (H)	 NTSC443 0.15V ₀ -D (H)	 PAL 0.3V ₀ -D (H)
 NTSC358 0.2V ₀ -D (H) NTSC443 0.2V ₀ -D (H)	 S (Y/C) 0.2V ₀ -D (H)	 PAL 0.9V ₀ -D (H) SECAM 0.9V ₀ -D (H)	 NTSC358 1V ₀ -D (H) NTSC443 1V ₀ -D (H) S (Y/C) 1V ₀ -D (H)
 COMPONENT 1V ₀ -D (H)	 4V ₀ -D (H)	 12V ₀ -D (H)	 12V ₀ -D (H)
 12V ₀ -D (H)	 12V ₀ -D (H)	 SECAM 0.8V ₀ -D (H)	 SECAM 0.5V ₀ -D (H)
 SECAM 0.8V ₀ -D (H)	 NTSC358 1V ₀ -D (H) NTSC443 1V ₀ -D (H) S (Y/C) 1V ₀ -D (H)	 12V ₀ -D (H)	 12V ₀ -D (H)
 PAL 1.2V ₀ -D (H)	 SECAM 1.2V ₀ -D (H)	 NTSC358 1.2V ₀ -D (H) NTSC443 1.2V ₀ -D (H)	 S (Y/C) 1.2V ₀ -D (H)
 COMPONENT 1.4V ₀ -D (H)	 PAL 1.3V ₀ -D (H)	 SECAM 1.2V ₀ -D (H)	 NTSC358 1.3V ₀ -D (H) NTSC443 1.3V ₀ -D (H) S (Y/C) 1.3V ₀ -D (H)
 PAL SECAM 1V ₀ -D (H) SECAM 1V ₀ -D (H) NTSC358 1V ₀ -D (H) NTSC443 1V ₀ -D (H) S (Y/C) 1V ₀ -D (H)	 PAL 0.35V ₀ -D (H)	 NTSC358 0.3V ₀ -D (H) NTSC443 0.3V ₀ -D (H) S (Y/C) 0.3V ₀ -D (H)	 PAL 0.2V ₀ -D (H)
 PAL 0.7V ₀ -D (H)	 SECAM 1.1V ₀ -D (H)	 NTSC358 1.0V ₀ -D (H) (3.58MHz) NTSC443 0.9V ₀ -D (H) (4.43MHz) S (Y/C) 1.0V ₀ -D (H) (3.58MHz)	 PAL 1.2V ₀ -D (H)
 PAL 0.5V ₀ -D (H)	 NTSC358 1.2V ₀ -D (H) NTSC443 0.9V ₀ -D (H) S (Y/C) 1.2V ₀ -D (H)	 PAL 0.4V ₀ -D (H)	 SECAM 0.1V ₀ -D (H)
 PAL 0.55V ₀ -D (H)	 SECAM 0.1V ₀ -D (H)	 NTSC358 0.4V ₀ -D (H) NTSC443 0.4V ₀ -D (H) S (Y/C) 0.4V ₀ -D (H)	 PAL SECAM 0.4V ₀ -D (H) 1V ₀ -D (H) 0.4V ₀ -D (H) COMPONENT 0.4V ₀ -D (H)

 NTSC358 0.4V ₀ -D (H) NTSC443 0.4V ₀ -D (H) S (Y/C) 0.4V ₀ -D (H)	 12V ₀ -D (H)	 PAL 11V ₀ -D (H)	 PAL 1.8V ₀ -D (H)	 PAL 0.9V ₀ -D (H) SECAM 1.1V ₀ -D (H) NTSC358 1.1V ₀ -D (H) NTSC443 0.9V ₀ -D (H) S (Y/C) 0.9V ₀ -D (H)
 PAL 0.35V ₀ -D (H)	 SECAM 0.35V ₀ -D (H)	 NTSC358 0.35V ₀ -D (H) NTSC443 0.32V ₀ -D (H) S (Y/C) 0.35V ₀ -D (H)	 COMPONENT 0.28V ₀ -D (H)	 PAL 0.45V ₀ -D (H)
 SECAM 0.45V ₀ -D (H)	 NTSC358 0.45V ₀ -D (H) NTSC443 0.4V ₀ -D (H)	 S (Y/C) 0.33V ₀ -D (H) COMPONENT 0.38V ₀ -D (H)	 PAL SECAM 0.5V ₀ -D (H) COMPONENT 0.6V ₀ -D (H)	 NTSC358 0.8V ₀ -D (H) NTSC443 0.8V ₀ -D (H) S (Y/C) 0.8V ₀ -D (H)
 PAL 0.38V ₀ -D (H)	 SECAM 0.38V ₀ -D (H)	 SECAM 0.35V ₀ -D (H)	 NTSC358 0.8V ₀ -D (H) NTSC443 0.8V ₀ -D (H)	 S (Y/C) 0.8V ₀ -D (H)
 COMPONENT 0.3V ₀ -D (H)	 4.8V ₀ -D (V)	 10.4V ₀ -D (V)	 3.5V ₀ -D (V)	 3.5V ₀ -D (H)
 PAL 2.8V ₀ -D (H)	 SECAM 3V ₀ -D (H)	 NTSC358 3.2V ₀ -D (H) NTSC443 3.4V ₀ -D (H) S (Y/C) 3.2V ₀ -D (H)	 COMPONENT 3V ₀ -D (H)	 RGB 2.7V ₀ -D (H)
 PAL 2.8V ₀ -D (H)	 SECAM 2.8V ₀ -D (H)	 NTSC358 3.4V ₀ -D (H) NTSC443 3.4V ₀ -D (H) S (Y/C) 3.4V ₀ -D (H)	 RGB 2.8V ₀ -D (H)	 COMPONENT 3V ₀ -D (H)
 PAL 2.5V ₀ -D (H)	 SECAM 2.8V ₀ -D (H)	 NTSC358 3.1V ₀ -D (H) NTSC443 3.1V ₀ -D (H) S (Y/C) 3.1V ₀ -D (H)	 RGB 2.8V ₀ -D (H)	 COMPONENT 2.8V ₀ -D (H)
 PAL 0.8V ₀ -D (V) SECAM 0.8V ₀ -D (V) COMPONENT 0.8V ₀ -D (V)	 NTSC358 0.8V ₀ -D (V) NTSC443 0.8V ₀ -D (V) S (Y/C) 0.7V ₀ -D (V)	 11V ₀ -D (H)	 10V ₀ -D (H)	 2.4V ₀ -D (H)
 PAL 72V ₀ -D (H)	 SECAM 80V ₀ -D (H)	 NTSC358 80V ₀ -D (H) NTSC443 80V ₀ -D (H) S (Y/C) 80V ₀ -D (H)	 RGB 70V ₀ -D (H)	 COMPONENT 80V ₀ -D (H)
 PAL 76V ₀ -D (H)	 SECAM 72V ₀ -D (H)	 NTSC443 80V ₀ -D (H) S (Y/C) 88V ₀ -D (H)	 RGB 70V ₀ -D (H)	 COMPONENT 80V ₀ -D (H)
 PAL 68V ₀ -D (H)	 SECAM 64V ₀ -D (H)	 NTSC358 80V ₀ -D (H) NTSC443 80V ₀ -D (H) S (Y/C) 80V ₀ -D (H)	 RGB 70V ₀ -D (H)	 COMPONENT 80V ₀ -D (H)

B [SIGNAL PROCESS]

- B BOARD - (Component Side)

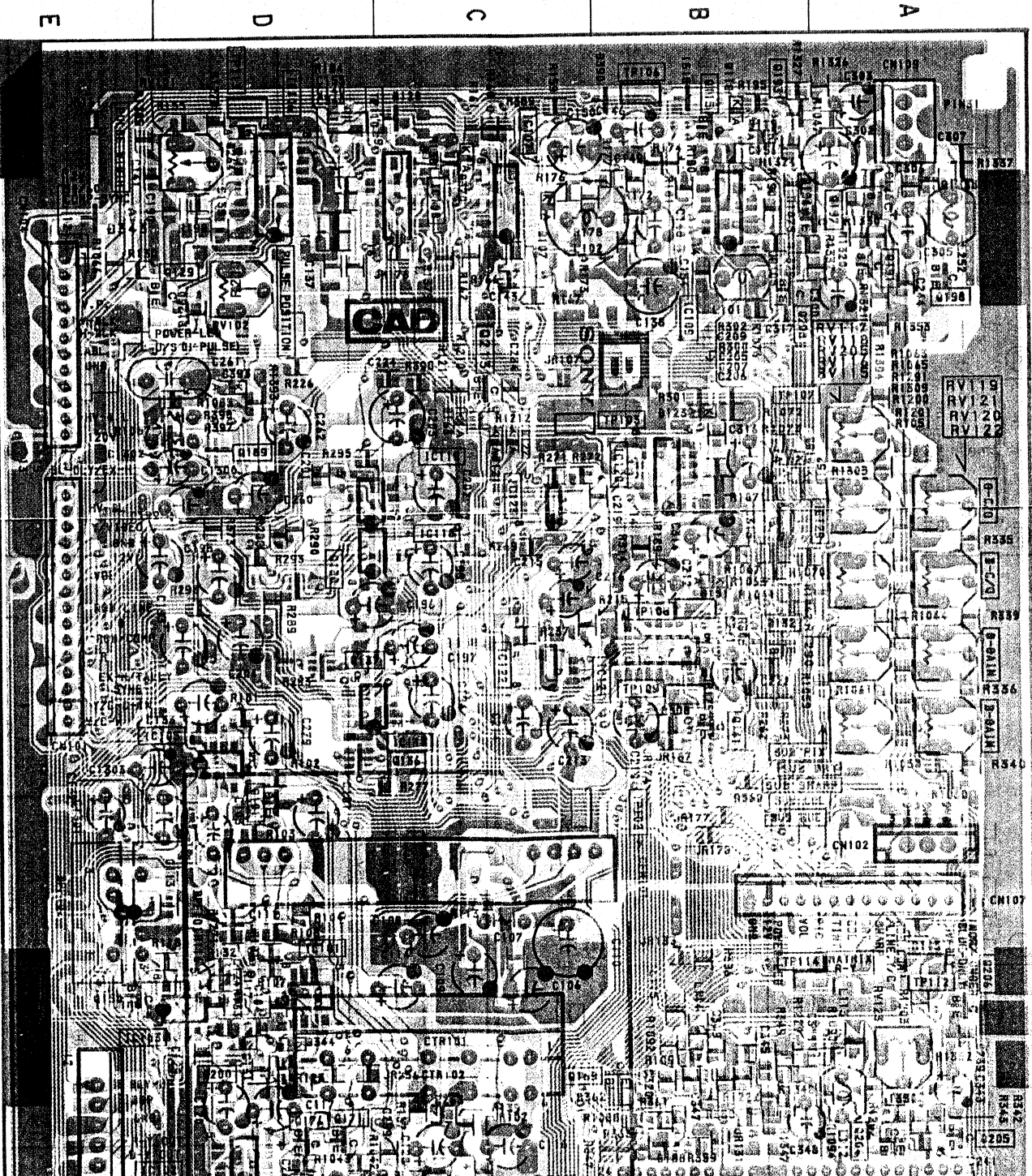

B BOARD (Component Side)			
IC	D-5	0147	C-8
	D-6	0150	A-9
IC101	D-5	0150	A-9
IC102	D-6	0152	B-9
IC103	E-5	0155	B-9
IC104	C-6	0157	A-8
IC105	D-4	0158	B-8
IC106	D-1	0159	B-8
IC107	C-1	0164	A-8
IC108	C-1	0166	B-8
IC109	B-2	0171	D-6
IC110	D-7	0176	D-6
IC111	C-7	0189	D-2
IC112	D-8	0191	A-2
IC113	D-9	0193	B-1
IC114	D-8	0196	A-1
IC115	C-9	0197	A-1
IC116	B-7	0198	A-2
IC117	D-4	0200	D-5
IC118	D-3	0204	A-6
IC119	D-3	0205	A-6
IC120	B-3	0206	A-5
IC121	B-3	0208	B-2
IC122	C-3	0209	A-9
IC123	C-3	0210	B-9
IC124	B-6	0211	B-9
IC125	B-7	0212	B-7
IC126	B-7	0299	A-7
IC127	A-8		
IC128	C-8		
IC129	B-3		
TRANSISTOR	D-4	D107	D-5
	A-8	D122	C-2
Q101	D-4	D122	C-2
Q104	A-8	D123	B-2
Q109	A-8	D128	C-1
Q115	B-1	D130	A-8
Q119	D-8	D131	B-8
Q121	C-8	D132	B-8
Q124	D-7	D137	E-7
Q129	D-2	D138	C-8
Q132	B-3	D139	B-8
Q136	D-3	D146	C-4
Q137	D-3	D151	B-3
Q141	B-4	D152	B-3
Q146	B-8	D153	B-2
DIODE	D-5	D103	D-5
	C-1	D121	C-2
C-2	D122	C-2	
C-2	D123	C-2	
B-2	D128	B-2	
C-1	D128	C-1	
A-8	D130	A-8	
B-8	D131	B-8	
B-8	D132	B-8	
E-7	D137	E-7	
C-8	D138	C-8	
B-8	D139	B-8	
C-4	D146	C-4	
B-3	D151	B-3	
B-3	D152	B-3	
B-2	D153	B-2	
VARIABLE RESISTOR	D-1	RV101	D-1
	D-2	RV102	D-2
C-7	RV103	C-7	
D-8	RV104	D-8	
E-7	RV105	E-7	
E-8	RV106	E-8	
C-9	RV107	C-9	
D-9	RV108	D-9	
C-9	RV109	C-9	
C-9	RV110	C-9	
C-9	RV111	C-9	
D-8	RV112	D-8	
A-5	RV123	A-5	
A-7	RV124	A-7	
A-7	RV125	A-7	
A-3	RV205	A-3	
VARIABLE RESISTOR	D-9	RV101	D-9
	D-9	RV102	D-9
C-3	RV103	C-3	
D-2	RV104	D-2	
E-3	RV105	E-3	
E-3	RV106	E-3	
D-3	RV107	D-3	
C-2	RV108	C-2	
D-1	RV109	D-1	
C-1	RV110	C-1	
C-1	RV111	C-1	
C-1	RV112	C-1	
D-2	RV113	D-2	
C-2	RV114	C-2	
A-6	RV115	A-6	
A-7	RV116	A-7	
A-7	RV118	A-7	
A-7	RV119	A-7	
A-7	RV120	A-7	
A-7	RV121	A-7	
A-7	RV122	A-7	
A-3	RV123	A-3	
A-3	RV124	A-3	
A-3	RV125	A-3	
A-7	RV205	A-7	

- B BOARD - (Conductor Side)



B BOARD (Conductor Side)			
IC	D-6	0157	A-2
	C-4	0159	B-2
IC101	D-6	0159	B-2
IC124	C-4	0160	A-2
TRANSISTOR	D-6	0167	B-3
	C-6	0168	B-3
Q103	D-5	0170	B-3
Q106	D-7	0172	B-3
Q107	C-4	0173	C-3
Q108	C-5	0174	B-2
Q112	C-9	0175	A-3
Q113	B-9	0177	B-3
Q114	C-9	0178	E-5
Q116	C-9	0179	A-3
Q117	D-2	0190	B-8
Q118	C-3	0192	A-9
Q120	D-3	0194	A-9
Q122	D-3	0195	A-9
Q123	D-3	0199	A-9
Q125	E-2	0201	B-5
Q126	E-2	0202	B-5
Q127	E-2	0203	B-5
Q128	E-2	0209	A-1
Q129	E-2	0210	B-1
Q130	D-3	0211	B-1
Q131	D-1		
Q133	D-1		
Q134	D-2		
Q135	D-2		
Q139	D-8		
Q140	C-7		
Q142	B-7		
Q143	B-7		
Q144	A-4		
Q145	B-5		
Q146	A-2		
Q147	C-2		
Q148	A-2		
Q149	A-2		
Q151	A-1		
Q152	B-1		
Q153	B-4		
Q154	B-1		
Q155	B-1		
Q156	D-8		
DIODE	D-5	D104	D-5
	C-9	D106	C-9
C-9	D108	C-9	
C-9	D109	C-9	
D-9	D110	D-9	
D-9	D111	D-9	
B-9	D112	B-9	
B-9	D116	B-9	
A-7	D118	A-7	
A-7	D119	A-7	
A-7	D120	A-7	
A-6	D126	A-6	
D-8	D127	D-8	
E-1	D129	E-1	
A-4	D133	A-4	
B-4	D134	B-4	
B-4	D136	B-4	
VARIABLE RESISTOR	D-9	RV101	D-9
	D-9	RV102	D-9
C-3	RV103	C-3	
D-2	RV104	D-2	
E-3	RV105	E-3	
E-3	RV106	E-3	
D-3	RV107	D-3	
C-2	RV108	C-2	
D-1	RV109	D-1	
C-1	RV110	C-1	
C-1	RV111	C-1	
C-1	RV112	C-1	
D-2	RV113	D-2	
C-2	RV114	C-2	
A-6	RV115	A-6	
A-7	RV116	A-7	
A-7	RV118	A-7	
A-7	RV119	A-7	
A-7	RV120	A-7	
A-7	RV121	A-7	
A-7	RV122	A-7	
A-3	RV123	A-3	
A-3	RV124	A-3	
A-3	RV125	A-3	
A-7	RV205	A-7	

Schematic diagram

← B (2/2) board

Note :
 • : Pattern from the side which enables seeing.
 • : Pattern of the rear side.

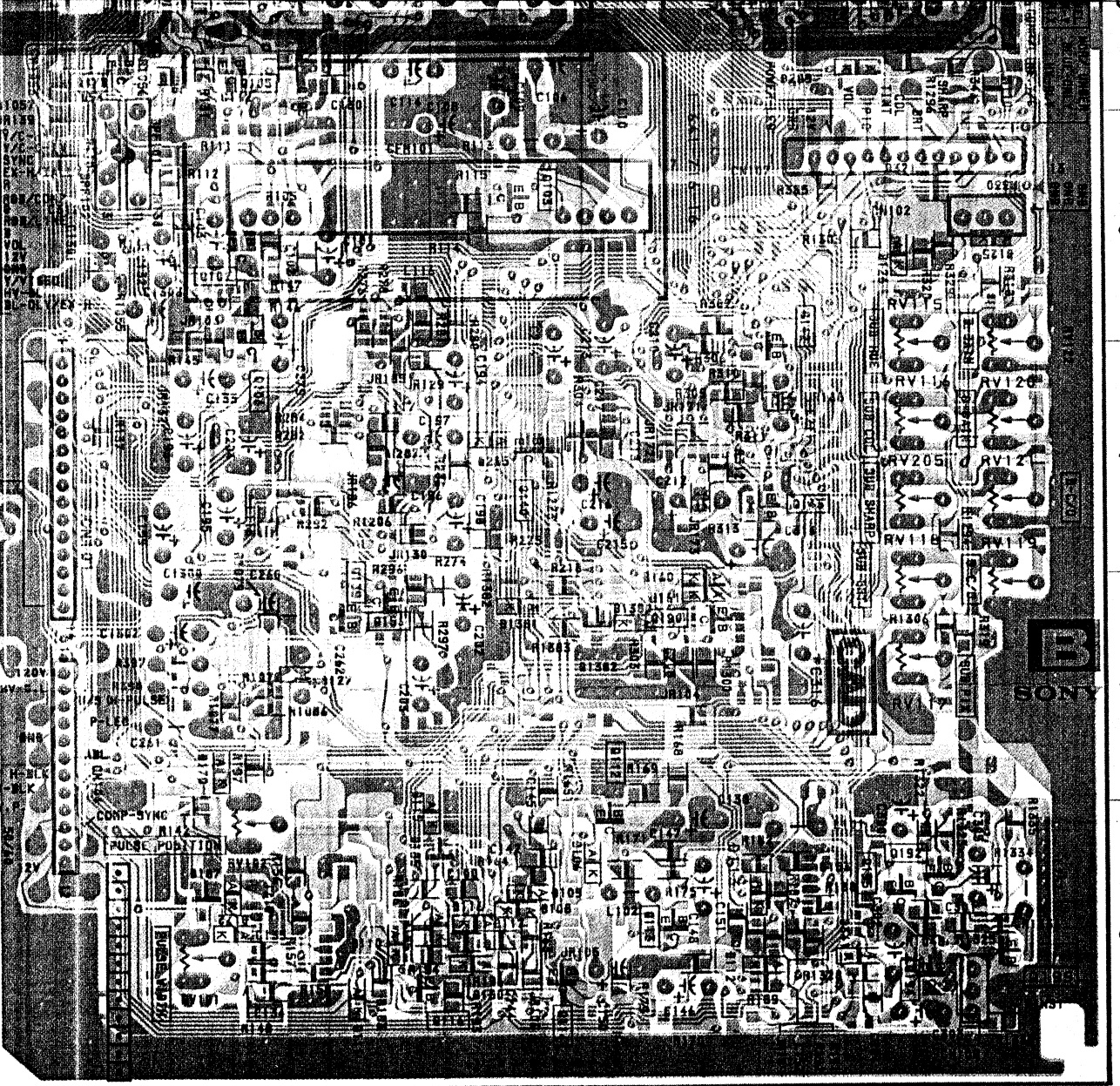
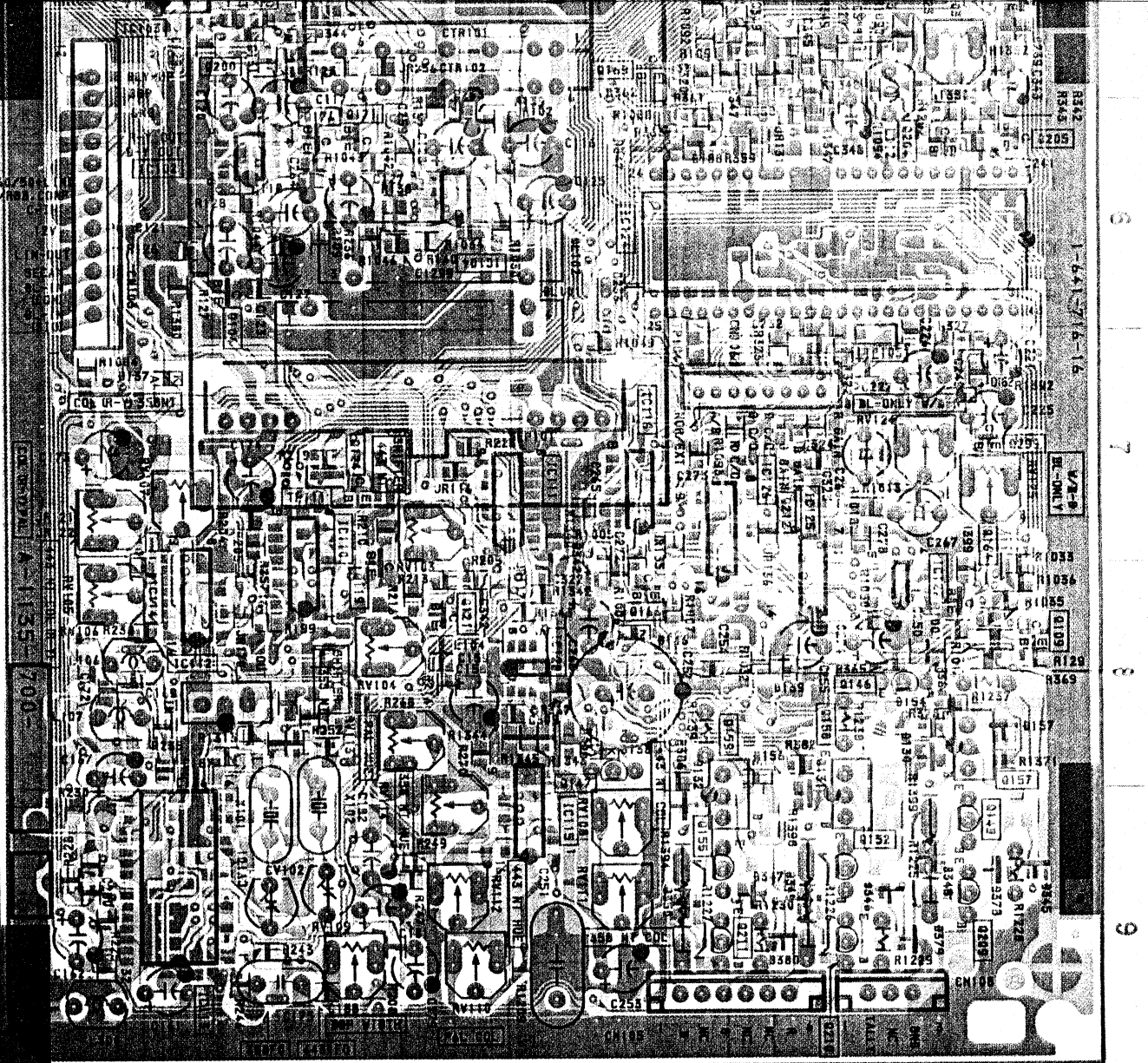

6-5. SEMICONDUCTORS

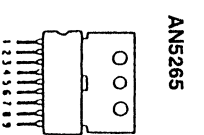

AN5265

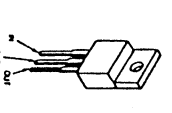

LM7805CT
TA7812S
μPC7805H

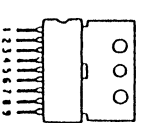

CXA1214P

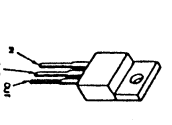

MC14538BF

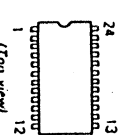

CXA1478S

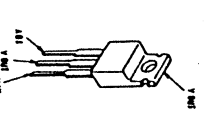

MS1279FP

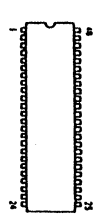

CX23025

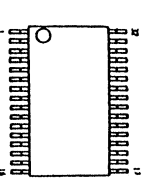

TC4501F
TC4511F

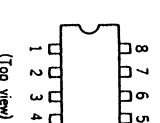

LAY7830



μPC1377C

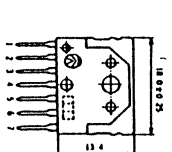

LM358DR
MM1111XFF
MM1113XFF
MM1114XFF
MM1148XFF
MM1149XF
NJM2245M
XRA10393F

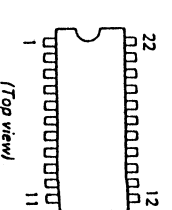

XRU4011BF
XRU4070BF

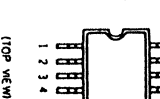

XRU4011BF
XRU4070BF

Note:
• : Pattern from the side which enables seeing.
• : Pattern of the rear side.

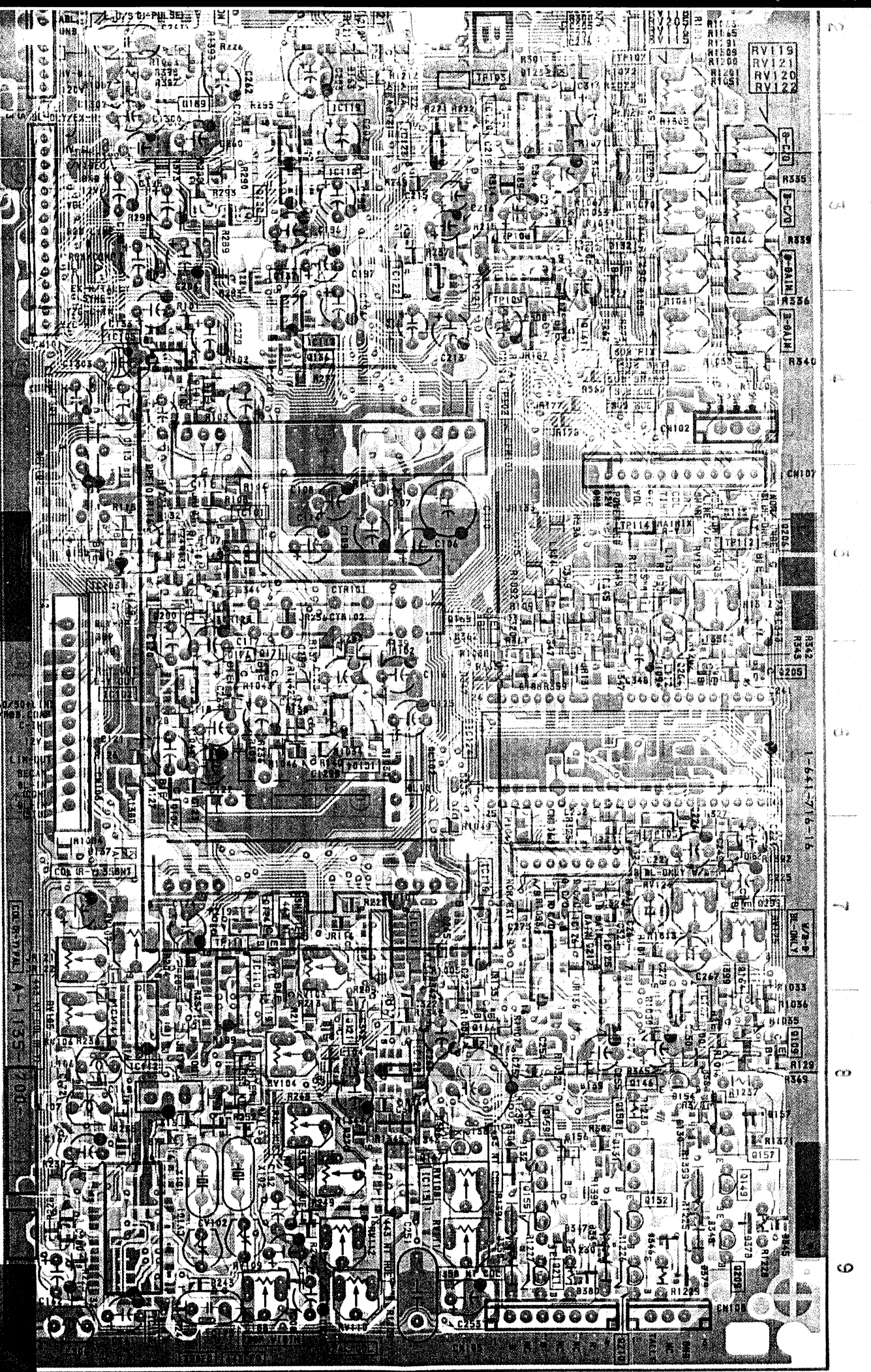

Side)

3 4 5 6 7 8 9

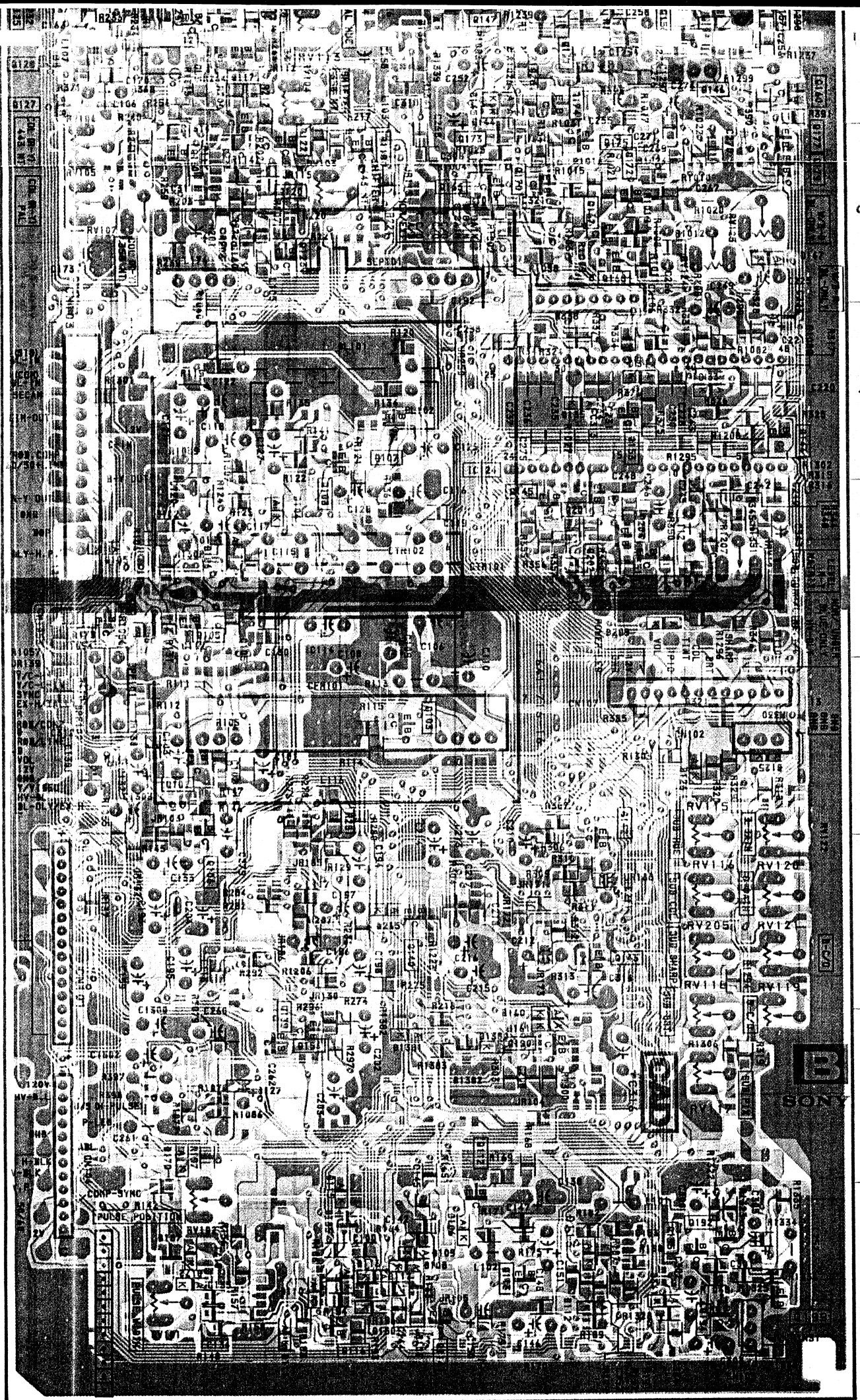

Side)

6-5. SEMICONDUCTORS

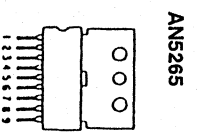

AN5265

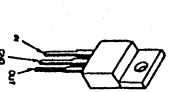

LM7805CT
TA7812S
LPC7805H

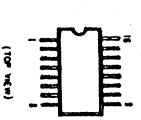

XRU4052BCF
XRU4053BCF
XRU4066BCF

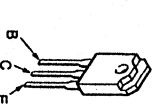

2SC2555

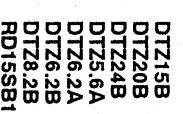

DTZ15B
DTZ20B
DTZ24B
DTZ5.6A
DTZ6.2A
DTZ6.2B
DTZ8.2B
RD15SB1

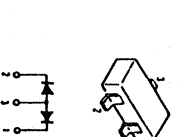

MA151WA

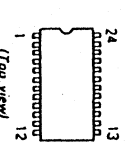

CXA1214P

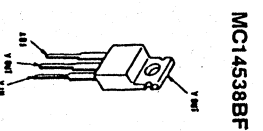

MC14538BF

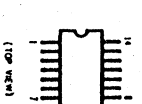

XRU4584BF

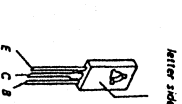

2SC2611
2SC2688



D10SC4M

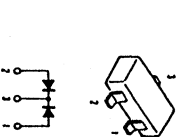

MA151WK

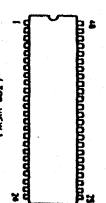

CXA1478S

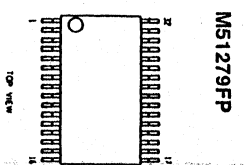

M51279FP



DTA144EK
DTC124EK
DTC144EK
2SA1037K
2SC2412K

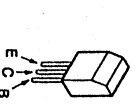

2SC2958

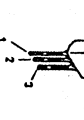

ERC81-004



MA157

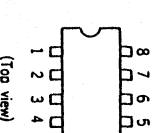

CX23025

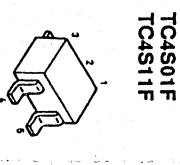

TC4S01F
TC4S11F



IMH2
IMX1T110

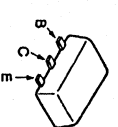

2SD874A-R

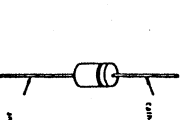

GP08DPK23
HSM83-TL
RD5.6EBZ7STN
RGP10GPKG23
RGP15J

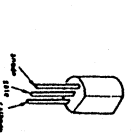

NI3T1

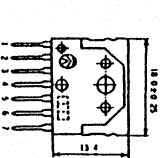

LA7930

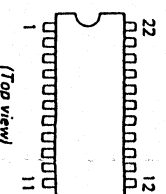

LPC1377C

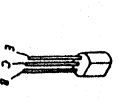

2SA1091-0
2SC1890-A
2SC2551-0
2SC2551R



2SK94

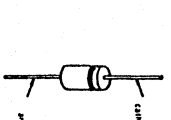

MA110

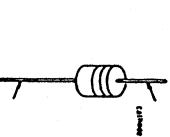

RD3.6ESB1
RD8.2ESB3

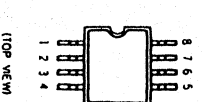

LM358DR
MM1113XFF
MM1113XFF
MM1114XFF
MM1114XFF
MM1148XFF
MM1149XFF
NJM2245M
XRA10393F

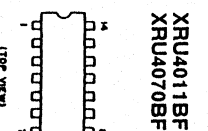

XRU4011BF
XRU4070BF

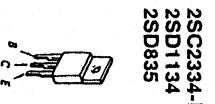

2SC2334-L
2SD1134
2SD835

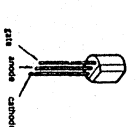

CH02AM-4

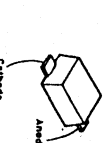

SEL3810DLC05
TLG123A

SECTION 7 EXPLODED VIEWS

NOTE :

- Items with on part number and on description are not stocked because they are seldom required for routine service.
- The construction parts of an assembled part are indicated with a collation number in the remark column.
- Items marked "*" are not stocked since they are seldom required for routine service. Some delay should be anticipated when ordering these items.

The components identified by shading and mark Δ are critical for safety. Replace only with part number specified.

7-1. CHASSIS

- : BVTP 3 x 8 7-685-646-79
- ▲ : BVTP 3 x 12 7-685-648-79

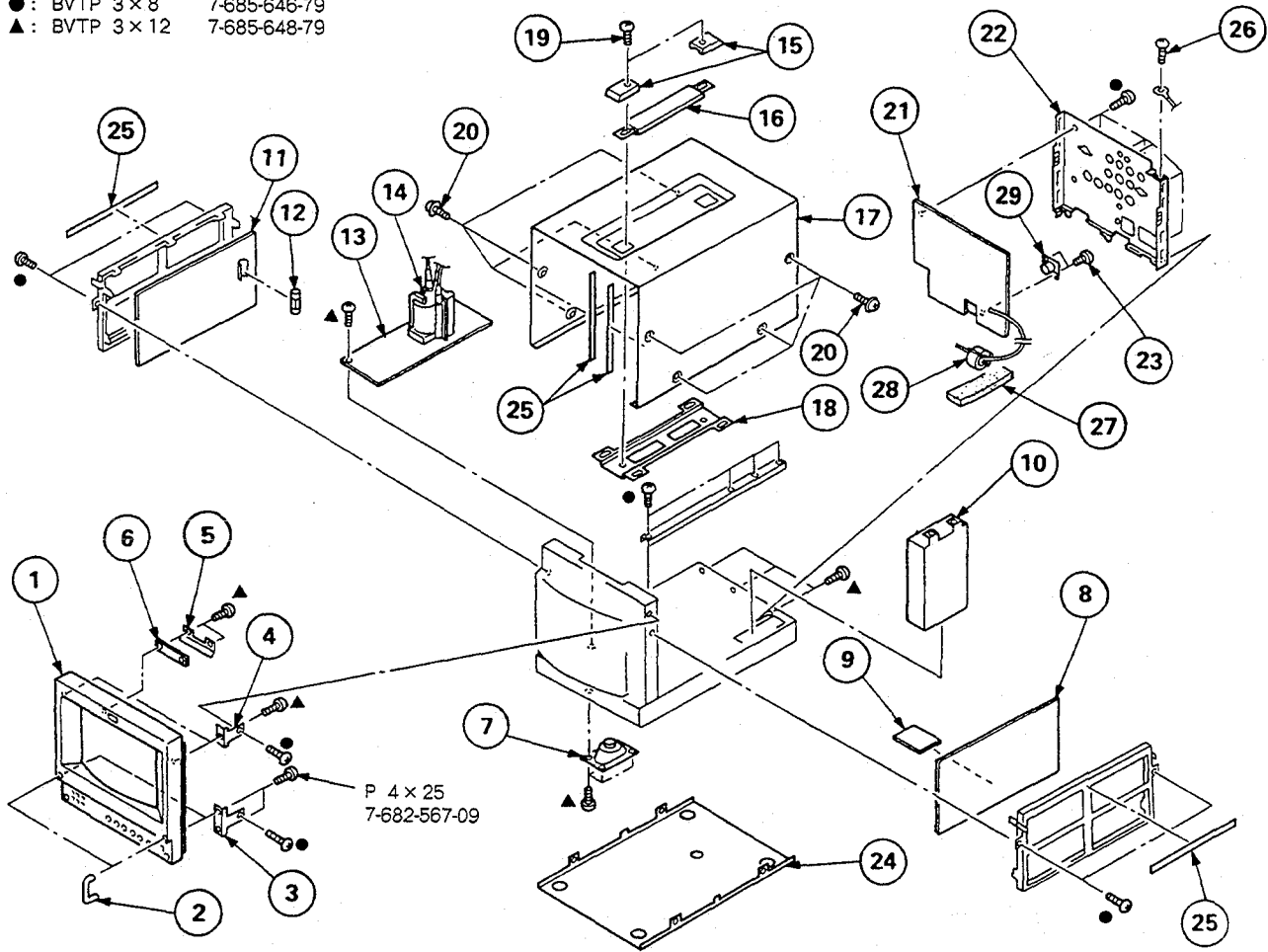

REF. NO.	PART NO.	DESCRIPTION	REMARK	REF. NO.	PART NO.	DESCRIPTION	REMARK
1	X-4032-139-1	BEZEL ASSY (PVM-9044QM)		15	4-034-847-01	HANDLE (BASE)	
1	X-4030-164-6	BEZEL ASSY (PVM-9041QM)		16	3-419-372-31	HANDLE	
2	4-037-569-01	HANDLE, PROTECTOR		17	*4-034-867-01	CABINET	
3	*4-034-845-01	BRACKET (L), BEZEL		18	*X-4030-273-1	REINFORCEMENT ASSY, HANDLE	
4	*4-034-846-01	BRACKET (U), BEZEL		19	4-035-452-01	SCREW (M4X10)	
5	*4-035-388-01	PLATE, LIGHT INTERCEPTION		20	4-034-834-01	SCREW (CLAW) (4X6), CASE	
6	*A-1390-276-A	X BOARD, CMOPLT		21	*A-1275-121-A	QA BOARD, COMPLETE	
7	1-544-252-11	SPEAKER		22	*4-034-864-71	CHASSIS, A	
8	*A-1135-716-A	B BOARD, COMPLETE		23	4-035-802-01	SCREW (M2.6X.6)	
9	*A-1394-368-A	S BOARD, COMPLETE		24	*4-034-870-02	CABINET, BOTTOM	
10	Δ 1-413-720-24	SWITCHING REGULATOR (SOPS-1021(A))		25	*4-035-691-01	CLOTH, VIBRATION PROOF	
11	*A-1346-251-A	D BOARD, COMPLETE		26	4-389-025-01	SCREW (M4X8) (EXT TOOTH WASHER)	
12	Δ 1-576-232-11	FUSE (H.B.C.) (5.0A/250V)		27	*4-036-058-01	SPONGE	
13	*A-1195-048-A	P BOARD, COMPLETE		28	1-941-913-02	CORE ASSY, FERRITE	
14	Δ 1-439-526-12	TRANSFORMER ASSY, FLYBACK		29	1-941-866-12	CONNECTOR ASSY	

PVM-9041QM/9044QM

7-2. PICTURE TUBE

▲: BVTP 3×12 7-685-648-79

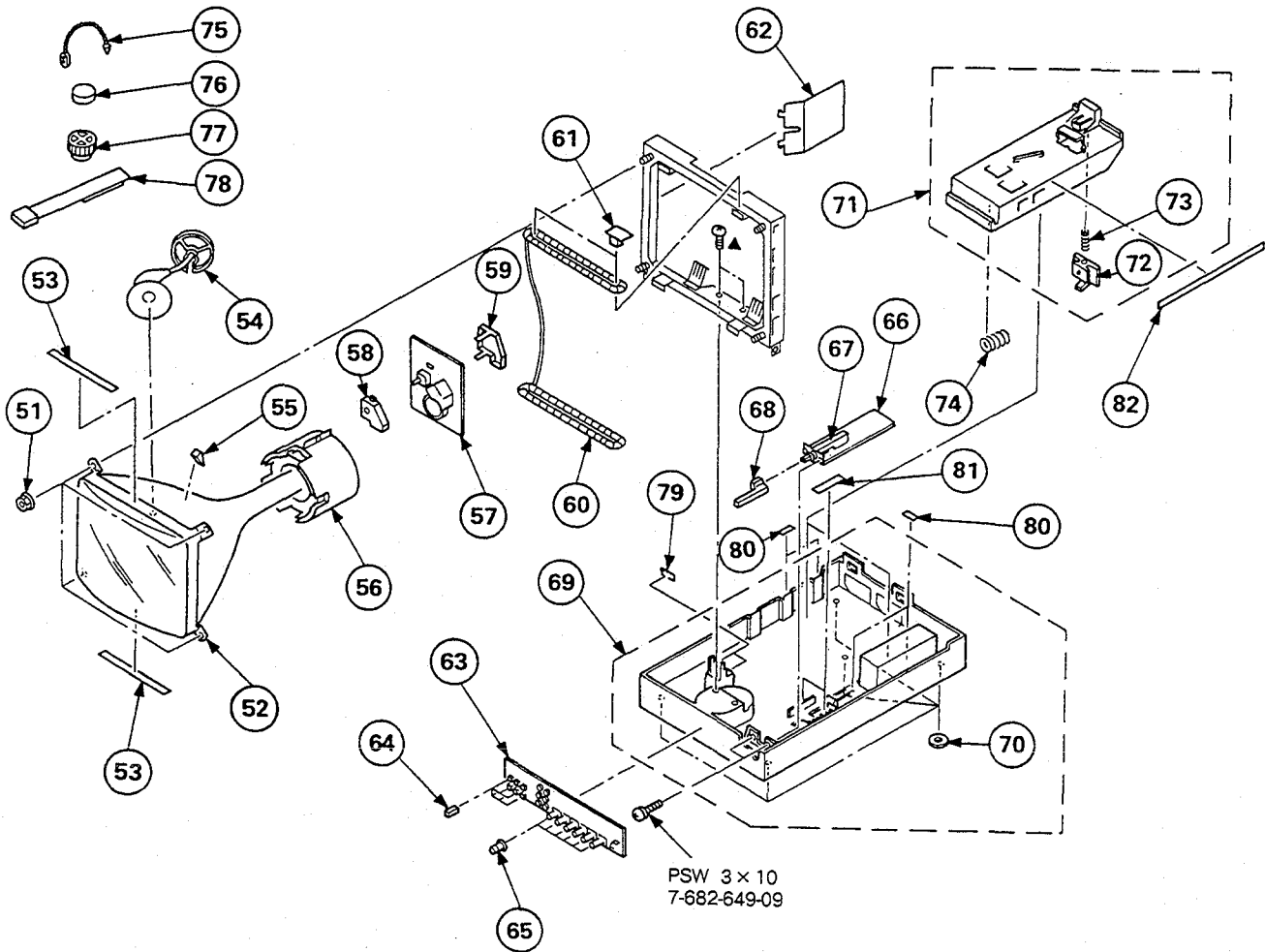

PSW 3×10
7-682-649-09

The components identified by shading and mark ▲ are critical for safety. Replace only with part number specified.

REF. NO.	PART NO.	DESCRIPTION	REMARK	REF. NO.	PART NO.	DESCRIPTION	REMARK
51	4-304-511-00	NUT (M5), FLANGE		70	4-034-840-01	RUBBER, FOOT	
52	▲ 8-737-154-05	PICTURE TUBE (09NDX) (PVM-9041QM)		71	*X-4030-163-1	GUIDE ASSY, BATTERY	72, 73
52	▲ 8-737-651-05	PICTURE TUBE (09FX) (PVM-9044QM)		72	4-034-861-01	KNOB, BATTERY	
53	4-035-332-01	CLOTH, PROTECTION		73	4-876-347-01	SPRING, COMPRESSION	
54	*4-034-856-01	HOLDER, HV CABLE		74	3-669-594-00	SPRING, COMPRESSION	
55	4-309-369-00	SPACER, DEFLECTION YOKE		75	4-308-870-00	CLIP, LEAD WIRE	
56	▲ 1-451-319-22	DEFLECTION YOKE (Y9FXC)		76	1-452-126-11	MAGNET	
57	*A-1331-183-A	CA BOARD, COMPLETE		77	1-452-094-00	MAGNET, ROTATABLE DISK; 15MM φ	
58	*4-376-133-11	COVER (MAIN), CV VOL		78	X-4308-815-0	PERMALLOY ASSY, CONVERGENCE	
59	*4-376-132-11	COVER (REAR LID), CV VOL		79	*4-036-047-02	RUBBER, VIBRATION PROOF	
60	▲ 1-426-043-12	COIL, DEGAUSSING		80	3-839-640-00	CUSHION	
61	4-380-534-01	CAP, DGC		81	3-831-441-11	CUSHION (F)	
62	*4-034-850-01	INSULATOR		82	*4-035-691-01	CLOTH, VIBRATION PROOF	
63	*A-1371-782-A	HA BOARD, COMPLETE					
64	4-034-849-01	SWITCH (SMALL), PUSH					
65	X-4030-162-2	KNOB ASSY, CONTROL					
66	*A-1241-070-A	FA BOARD, COMPLETE					
67	1-692-050-11	SWITCH, PUSH (AC POWER) (1KEY)					
68	4-034-841-11	BUTTON, POWER SWITCH					
69	*X-4030-166-1	CHASSIS ASSY, BOTTOM	70				

SECTION 8
ELECTRICAL PARTS LIST

B

NOTE:

The components identified by shading and mark Δ are critical for safety. Replace only with part number specified.

• Items marked "*" are not stocked since they are seldom required for routine service. Some delay should be anticipated when ordering these items.

• All variable and adjustable resistors have characteristic curve B, unless otherwise noted.

RESISTORS

• All resistors are in ohms.
• F: nonflammable

When indicating parts by reference number, please include the board name.

CAPACITORS

COILS

• MF: μ F, PF: μ PF • MMH: mH, UH: μ H

• The components identified by \boxtimes in this manual have been carefully factory-selected for each set in order to satisfy regulations regarding X-ray radiation. Should replacement be required, replace only with the value originally used.

• There are some cases the reference number on one board overlaps on the other board. Therefore, when ordering parts by the reference number, please include the board name.

REF.NO.	PART NO.	DESCRIPTION	REMARK	REF.NO.	PART NO.	DESCRIPTION	REMARK
*A-1135-716-A	B BOARD, COMPLETE	*****		C143	1-163-121-00	CERAMIC CHIP 150PF	5% 50V
	<FILTER>			C144	1-163-101-00	CERAMIC CHIP 22PF	5% 50V
BPF101	1-236-363-11	FILTER, BAND PASS		C145	1-163-131-00	CERAMIC CHIP 390PF	5% 50V
BPF102	1-236-364-11	FILTER, BAND PASS		C146	1-126-157-11	ELECT 10MF	20% 16V
	<CAPACITOR>			C147	1-164-232-11	CERAMIC CHIP 0.01MF	10% 50V
C101	1-124-589-11	ELECT 47MF	20% 16V	C148	1-126-160-11	ELECT 1MF	20% 50V
C102	1-163-031-11	CERAMIC CHIP 0.01MF	50V	C149	1-163-022-00	CERAMIC CHIP 0.012MF	10% 50V
C103	1-126-157-11	ELECT 10MF	20% 16V	C150	1-124-589-11	ELECT 47MF	20% 16V
C104	1-163-031-11	CERAMIC CHIP 0.01MF	50V	C151	1-163-131-00	CERAMIC CHIP 390PF	5% 50V
C105	1-163-031-11	CERAMIC CHIP 0.01MF	50V	C152	1-163-101-00	CERAMIC CHIP 22PF	5% 50V
C106	1-124-477-11	ELECT 47MF	20% 16V	C153	1-163-125-00	CERAMIC CHIP 220PF	5% 50V
C107	1-163-031-11	CERAMIC CHIP 0.01MF	50V	C154	1-163-031-11	CERAMIC CHIP 0.01MF	50V
C108	1-124-477-11	ELECT 47MF	20% 16V	C155	1-163-133-00	CERAMIC CHIP 470PF	5% 50V
C109	1-124-477-11	ELECT 47MF	20% 16V	C156	1-164-299-11	CERAMIC CHIP 0.22MF	10% 25V
C110	1-124-120-11	ELECT 220MF	20% 16V	C157	1-163-229-11	CERAMIC CHIP 12PF	5% 50V
C111	1-163-031-11	CERAMIC CHIP 0.01MF	50V	C158	1-124-477-11	ELECT 47MF	20% 16V
C112	1-163-031-11	CERAMIC CHIP 0.01MF	50V	C159	1-163-229-11	CERAMIC CHIP 12PF	5% 50V
C113	1-163-031-11	CERAMIC CHIP 0.01MF	50V	C160	1-163-229-11	CERAMIC CHIP 12PF	5% 50V
C114	1-124-477-11	ELECT 47MF	20% 16V	C161	1-124-902-00	ELECT 0.47MF	20% 50V
C115	1-163-031-11	CERAMIC CHIP 0.01MF	50V	C162	1-124-903-11	ELECT 1MF	20% 50V
C116	1-124-589-11	ELECT 47MF	20% 16V	C163	1-163-809-11	CERAMIC CHIP 0.047MF	10% 25V
C117	1-126-154-11	ELECT 47MF	20% 6.3V	C164	1-163-809-11	CERAMIC CHIP 0.047MF	10% 25V
C118	1-126-154-11	ELECT 47MF	20% 6.3V	C165	1-163-009-11	CERAMIC CHIP 0.001MF	10% 50V
C119	1-163-031-11	CERAMIC CHIP 0.01MF	50V	C166	1-163-031-11	CERAMIC CHIP 0.01MF	50V
C120	1-126-154-11	ELECT 47MF	20% 6.3V	C167	1-124-477-11	ELECT 47MF	20% 16V
C121	1-126-154-11	ELECT 47MF	20% 6.3V	C168	1-163-031-11	CERAMIC CHIP 0.01MF	50V
C122	1-124-477-11	ELECT 47MF	20% 16V	C169	1-163-243-11	CERAMIC CHIP 47PF	5% 50V
C123	1-163-031-11	CERAMIC CHIP 0.01MF	50V	C170	1-163-129-00	CERAMIC CHIP 330PF	5% 50V
C124	1-163-031-11	CERAMIC CHIP 0.01MF	50V	C171	1-163-243-11	CERAMIC CHIP 47PF	5% 50V
C125	1-126-154-11	ELECT 47MF	20% 6.3V	C172	1-163-129-00	CERAMIC CHIP 330PF	5% 50V
C126	1-163-031-11	CERAMIC CHIP 0.01MF	50V	C173	1-124-589-11	ELECT 47MF	20% 16V
C127	1-126-154-11	ELECT 47MF	20% 6.3V	C174	1-124-477-11	ELECT 47MF	20% 16V
C128	1-126-154-11	ELECT 47MF	20% 6.3V	C175	1-108-792-11	MYLAR 0.001MF	5% 50V
C129	1-163-031-11	CERAMIC CHIP 0.01MF	50V	C176	1-163-031-11	CERAMIC CHIP 0.01MF	50V
C130	1-163-031-11	CERAMIC CHIP 0.01MF	50V	C177	1-163-031-11	CERAMIC CHIP 0.01MF	50V
C131	1-163-031-11	CERAMIC CHIP 0.01MF	50V	C178	1-163-031-11	CERAMIC CHIP 0.01MF	50V
C132	1-124-589-11	ELECT 47MF	20% 16V	C179	1-126-160-11	ELECT 1MF	20% 50V
C133	1-124-589-11	ELECT 47MF	20% 16V	C180	1-163-031-11	CERAMIC CHIP 0.01MF	50V
C134	1-163-275-11	CERAMIC CHIP 0.001MF	5% 50V	C181	1-126-154-11	ELECT 47MF	20% 6.3V
C135	1-163-113-00	CERAMIC CHIP 68PF	5% 50V	C182	1-126-163-11	ELECT 4.7MF	20% 16V
C137	1-163-249-11	CERAMIC CHIP 82PF	5% 50V	C183	1-164-232-11	CERAMIC CHIP 0.01MF	10% 50V
C138	1-124-589-11	ELECT 47MF	20% 16V	C184	1-163-031-11	CERAMIC CHIP 0.01MF	50V
C139	1-163-031-11	CERAMIC CHIP 0.01MF	50V	C185	1-163-031-11	CERAMIC CHIP 0.01MF	50V
C140	1-163-205-00	CERAMIC CHIP 0.001MF	5% 50V	C186	1-163-099-00	CERAMIC CHIP 18PF	5% 50V
C141	1-163-141-00	CERAMIC CHIP 0.001MF	5% 50V	C187	1-163-031-11	CERAMIC CHIP 0.01MF	50V
C142	1-163-031-11	CERAMIC CHIP 0.01MF	50V	C188	1-163-031-11	CERAMIC CHIP 0.01MF	50V
				C189	1-163-035-00	CERAMIC CHIP 0.047MF	50V
				C190	1-163-121-00	CERAMIC CHIP 150PF	5% 50V
				C191	1-163-031-11	CERAMIC CHIP 0.01MF	50V
				C192	1-163-031-11	CERAMIC CHIP 0.01MF	50V
				C193	1-124-589-11	ELECT 47MF	20% 16V

B

REF. NO.	PART NO.	DESCRIPTION	REMARK	REF. NO.	PART NO.	DESCRIPTION	REMARK
C194	1-124-589-11	ELECT 47MF	20% 16V	C261	1-137-193-11	FILM 0.39MF	5% 50V
C195	1-124-589-11	ELECT 47MF	20% 16V	C262	1-124-465-00	ELECT 0.47MF	20% 50V
C196	1-124-589-11	ELECT 47MF	20% 16V	C264	1-163-123-00	CERAMIC CHIP 180PF	5% 50V
C197	1-124-589-11	ELECT 47MF	20% 16V	C265	1-163-129-00	CERAMIC CHIP 330PF	5% 50V
C198	1-124-589-11	ELECT 47MF	20% 16V	C266	1-126-320-11	ELECT 10MF	20% 16V
C199	1-124-589-11	ELECT 47MF	20% 16V	C267	1-126-320-11	ELECT 10MF	20% 16V
C202	1-124-589-11	ELECT 47MF	20% 16V	C268	1-124-477-11	ELECT 47MF	20% 16V
C203	1-124-589-11	ELECT 47MF	20% 16V	C269	1-164-004-11	CERAMIC CHIP 0.1MF	10% 25V
C204	1-124-589-11	ELECT 47MF	20% 16V	C270	1-164-004-11	CERAMIC CHIP 0.1MF	10% 25V
C205	1-163-101-00	CERAMIC CHIP 22PF	5% 50V	C271	1-163-809-11	CERAMIC CHIP 0.047MF	10% 25V
C206	1-164-298-11	CERAMIC CHIP 0.15MF	10% 25V	C272	1-163-129-00	CERAMIC CHIP 330PF	5% 50V
C207	1-164-298-11	CERAMIC CHIP 0.15MF	10% 25V	C273	1-163-129-00	CERAMIC CHIP 330PF	5% 50V
C208	1-163-101-00	CERAMIC CHIP 22PF	5% 50V	C274	1-124-477-11	ELECT 47MF	20% 16V
C209	1-164-004-11	CERAMIC CHIP 0.1MF	10% 25V	C275	1-163-119-00	CERAMIC CHIP 120PF	5% 50V
C210	1-124-589-11	ELECT 47MF	20% 16V	C277	1-163-097-00	CERAMIC CHIP 15PF	5% 50V
C211	1-124-589-11	ELECT 47MF	20% 16V	C278	1-163-809-11	CERAMIC CHIP 0.047MF	10% 25V
C212	1-124-589-11	ELECT 47MF	20% 16V	C279	1-126-157-11	ELECT 10MF	20% 16V
C213	1-124-589-11	ELECT 47MF	20% 16V	C280	1-163-117-00	CERAMIC CHIP 100PF	5% 50V
C214	1-126-157-11	ELECT 10MF	20% 16V	C281	1-163-031-11	CERAMIC CHIP 0.01MF	50V
C215	1-126-157-11	ELECT 10MF	20% 16V	C282	1-163-031-11	CERAMIC CHIP 0.01MF	50V
C216	1-126-157-11	ELECT 10MF	20% 16V	C283	1-163-031-11	CERAMIC CHIP 0.01MF	50V
C217	1-163-031-11	CERAMIC CHIP 0.01MF	50V	C299	1-163-031-11	CERAMIC CHIP 0.01MF	50V
C218	1-164-298-11	CERAMIC CHIP 0.15MF	10% 25V	C300	1-126-157-11	ELECT 10MF	20% 16V
C219	1-163-009-11	CERAMIC CHIP 0.001MF	10% 50V	C301	1-163-809-11	CERAMIC CHIP 0.047MF	10% 25V
C220	1-163-031-11	CERAMIC CHIP 0.01MF	50V	C302	1-124-589-11	ELECT 47MF	20% 16V
C221	1-124-903-11	ELECT 1MF	20% 50V	C303	1-126-157-11	ELECT 10MF	20% 16V
C222	1-163-093-00	CERAMIC CHIP 10PF	5% 50V	C304	1-163-125-00	CERAMIC CHIP 220PF	5% 50V
C223	1-163-031-11	CERAMIC CHIP 0.01MF	50V	C305	1-124-257-00	ELECT 2.2MF	20% 50V
C225	1-124-477-11	ELECT 47MF	20% 16V	C306	1-163-115-00	CERAMIC CHIP 82PF	5% 50V
C226	1-163-031-11	CERAMIC CHIP 0.01MF	50V	C307	1-163-145-00	CERAMIC CHIP 0.0015MF	5% 50V
C227	1-163-038-00	CERAMIC CHIP 0.1MF	25V	C308	1-164-004-11	CERAMIC CHIP 0.1MF	10% 25V
C228	1-163-986-00	CERAMIC CHIP 0.027MF	10% 25V	C309	1-164-004-11	CERAMIC CHIP 0.1MF	10% 25V
C229	1-163-031-11	CERAMIC CHIP 0.01MF	50V	C310	1-164-004-11	CERAMIC CHIP 0.1MF	10% 25V
C230	1-163-038-00	CERAMIC CHIP 0.1MF	25V	C312	1-163-031-11	CERAMIC CHIP 0.01MF	50V
C231	1-163-986-00	CERAMIC CHIP 0.027MF	10% 25V	C313	1-163-115-00	CERAMIC CHIP 82PF	5% 50V
C232	1-163-031-11	CERAMIC CHIP 0.01MF	50V	C314	1-126-157-11	ELECT 10MF	20% 16V
C233	1-163-031-11	CERAMIC CHIP 0.01MF	50V	C315	1-164-299-11	CERAMIC CHIP 0.22MF	10% 25V
C234	1-163-038-00	CERAMIC CHIP 0.1MF	25V	C316	1-126-157-11	ELECT 10MF	20% 16V
C235	1-163-986-00	CERAMIC CHIP 0.027MF	10% 25V	C317	1-163-031-11	CERAMIC CHIP 0.01MF	50V
C236	1-163-031-11	CERAMIC CHIP 0.01MF	50V	C318	1-163-095-00	CERAMIC CHIP 12PF	5% 50V
C237	1-163-031-11	CERAMIC CHIP 0.01MF	50V	C319	1-163-095-00	CERAMIC CHIP 12PF	5% 50V
C238	1-164-299-11	CERAMIC CHIP 0.22MF	10% 25V	C320	1-163-095-00	CERAMIC CHIP 12PF	5% 50V
C239	1-163-809-11	CERAMIC CHIP 0.047MF	10% 25V	C321	1-163-121-00	CERAMIC CHIP 150PF	5% 50V
C240	1-163-809-11	CERAMIC CHIP 0.047MF	10% 25V	C322	1-163-121-00	CERAMIC CHIP 150PF	5% 50V
C241	1-163-809-11	CERAMIC CHIP 0.047MF	10% 25V	C324	1-163-119-00	CERAMIC CHIP 120PF	5% 50V
C242	1-163-113-00	CERAMIC CHIP 68PF	5% 50V	C340	1-163-205-00	CERAMIC CHIP 0.001MF	5% 50V
C243	1-163-031-11	CERAMIC CHIP 0.01MF	50V	C344	1-163-092-00	CERAMIC CHIP 9PF	0.25PF 50V
C244	1-163-103-00	CERAMIC CHIP 27PF	5% 50V	C345	1-163-109-00	CERAMIC CHIP 47PF	5% 50V
C245	1-163-105-00	CERAMIC CHIP 33PF	5% 50V	C346	1-163-109-00	CERAMIC CHIP 47PF	5% 50V
C246	1-163-809-11	CERAMIC CHIP 0.047MF	10% 25V	C347	1-163-109-00	CERAMIC CHIP 47PF	5% 50V
C247	1-163-809-11	CERAMIC CHIP 0.047MF	10% 25V	C1293	1-163-119-00	CERAMIC CHIP 120PF	5% 50V
C248	1-163-809-11	CERAMIC CHIP 0.047MF	10% 25V	C1294	1-163-119-00	CERAMIC CHIP 120PF	5% 50V
C249	1-126-101-11	ELECT 100MF	20% 16V	C1295	1-163-119-00	CERAMIC CHIP 120PF	5% 50V
C250	1-163-017-00	CERAMIC CHIP 0.0047MF	10% 50V	C1296	1-163-115-00	CERAMIC CHIP 82PF	5% 50V
C251	1-110-364-11	MYLAR 0.1MF	10% 200V	C1297	1-163-103-00	CERAMIC CHIP 27PF	5% 50V
C252	1-123-935-00	ELECT 33MF	20% 160V	C1298	1-163-113-00	CERAMIC CHIP 68PF	5% 50V
C253	1-124-477-11	ELECT 47MF	20% 16V	C1299	1-163-093-00	CERAMIC CHIP 10PF	5% 50V
C254	1-163-031-11	CERAMIC CHIP 0.01MF	50V	C1300	1-126-160-11	ELECT 1MF	20% 50V
C255	1-124-477-11	ELECT 47MF	20% 16V	C1301	1-126-160-11	ELECT 1MF	20% 50V
C256	1-163-129-00	CERAMIC CHIP 330PF	5% 50V	C1302	1-126-160-11	ELECT 1MF	20% 50V
C257	1-163-129-00	CERAMIC CHIP 330PF	5% 50V	C1303	1-126-160-11	ELECT 1MF	20% 50V
C258	1-163-129-00	CERAMIC CHIP 330PF	5% 50V				
C259	1-163-031-11	CERAMIC CHIP 0.01MF	50V				
C260	1-124-465-00	ELECT 0.47MF	20% 50V				

<FILTER>



REF. NO.	PART NO.	DESCRIPTION	REMARK	REF. NO.	PART NO.	DESCRIPTION	REMARK
CFM101	1-464-880-11	FILTER BLOCK, COM (CFB-2)		D151	8-719-404-46	DIODE MA110	
		<CONNECTOR>		D152	8-719-404-46	DIODE MA110	
CN101	1-506-480-11	PIN, CONNECTOR 15P		D153	8-719-977-20	DIODE DTZ8.2B	
CN102	*1-564-506-11	PLUG, CONNECTOR 3P		D154	8-719-404-46	DIODE MA110	
CN103	*1-565-503-11	CONNECTOR, BOARD TO BOARD 12P		D155	8-719-404-46	DIODE MA110	
CN104	*1-564-011-11	PIN, CONNECTOR 12P		D156	8-719-404-46	DIODE MA110	
CN105	*1-564-509-11	PLUG, CONNECTOR 6P		D157	8-719-901-83	DIODE 1SS83	
CN106	1-506-473-11	PIN, CONNECTOR 8P		D158	8-719-901-83	DIODE 1SS83	
CN107	1-506-478-11	PIN, CONNECTOR 13P		D159	8-719-901-83	DIODE 1SS83	
CN108	*1-564-506-11	PLUG, CONNECTOR 3P		D160	8-719-404-46	DIODE MA110	
		<TRAP MODULE>		D161	8-719-404-46	DIODE MA110	
CTR101	1-236-366-11	MODULE, TRAP		D162	8-719-404-46	DIODE MA110	
CTR102	1-236-365-11	MODULE, TRAP		D170	8-719-404-46	DIODE MA110	
		<TRIMMER>		D185	8-719-104-34	DIODE 1S2836	
CV101	1-141-418-11	CAP, ADJ		D186	8-719-801-78	DIODE 1SS184	
CV102	1-141-418-11	CAP, ADJ		D187	8-719-800-76	DIODE 1SS226	
		<DIODE>		D188	8-719-800-76	DIODE 1SS226	
D103	8-719-404-46	DIODE MA110		D191	8-719-104-34	DIODE 1S2836	
D104	8-719-404-46	DIODE MA110		D285	8-719-404-46	DIODE MA110	
D105	8-719-404-46	DIODE MA110		D289	8-719-404-46	DIODE MA110	
D106	8-719-404-46	DIODE MA110		D341	8-719-404-46	DIODE MA110	
D107	8-719-404-46	DIODE MA110		D342	8-719-104-34	DIODE 1S2836	
D108	8-719-404-46	DIODE MA110		D343	8-719-800-76	DIODE 1SS226	
D109	8-719-404-46	DIODE MA110		D344	8-719-105-99	DIODE RD6.2M-B1	
D110	8-719-404-46	DIODE MA110		D345	8-719-901-83	DIODE 1SS83	
D111	8-719-404-46	DIODE MA110		D346	8-719-901-83	DIODE 1SS83	
D112	8-719-404-46	DIODE MA110		D347	8-719-901-83	DIODE 1SS83	
D113	8-719-404-46	DIODE MA110		D348	8-719-800-76	DIODE 1SS226	
D117	8-719-404-46	DIODE MA110		D349	8-719-800-76	DIODE 1SS226	
D120	8-719-404-46	DIODE MA110		D350	8-719-800-76	DIODE 1SS226	
D121	8-719-404-46	DIODE MA110		D390	8-719-800-76	DIODE 1SS226	
D122	8-719-404-46	DIODE MA110		D393	8-719-404-46	DIODE MA110	
D123	8-719-404-46	DIODE MA110				<DELAY LINE>	
D125	8-719-404-46	DIODE MA110		DL101	1-415-632-11	DELAY LINE, Y	
D126	8-719-404-46	DIODE MA110		DL102	1-415-633-11	DELAY LINE, Y	
D127	8-719-404-46	DIODE MA110				<IC>	
D128	8-719-801-78	DIODE 1SS184		IC101	8-759-084-76	IC MM1111XF	
D129	8-719-404-46	DIODE MA110		IC102	8-759-287-89	IC MM1113XFF	
D130	8-719-800-76	DIODE 1SS226		IC103	8-759-287-89	IC MM1113XFF	
D131	8-719-800-76	DIODE 1SS226		IC104	8-759-287-89	IC MM1113XFF	
D132	8-719-800-76	DIODE 1SS226		IC105	8-759-084-76	IC MM1111XF	
D133	8-719-404-46	DIODE MA110		IC106	8-759-009-51	IC MC1453BBF	
D134	8-719-404-46	DIODE MA110		IC107	8-759-509-57	IC XRU4584BF	
D135	8-719-404-46	DIODE MA110		IC108	8-759-509-17	IC XRU4053BCF	
D136	8-719-404-46	DIODE MA110		IC109	8-759-509-37	IC XRU4070BF	
D137	8-719-404-46	DIODE MA110		IC110	8-759-509-17	IC XRU4053BCF	
D138	8-719-404-46	DIODE MA110		IC111	8-759-509-17	IC XRU4053BCF	
D139	8-719-404-46	DIODE MA110		IC112	8-759-924-12	IC LM7805CT	
D144	8-719-404-46	DIODE MA110		IC113	8-759-631-08	IC M51279FP	
D145	8-719-404-46	DIODE MA110		IC114	8-759-932-64	IC BU4052BCF	
D146	8-719-404-46	DIODE MA110		IC115	8-759-932-64	IC BU4052BCF	
D147	8-719-404-46	DIODE MA110		IC116	8-759-509-05	IC XRU4066BCF	
D148	8-719-404-46	DIODE MA110		IC117	8-759-711-32	IC NJM2245M	
D149	8-719-404-46	DIODE MA110		IC118	8-759-711-32	IC NJM2245M	
D150	8-719-404-46	DIODE MA110		IC119	8-759-711-32	IC NJM2245M	
				IC120	8-759-509-05	IC XRU4066BCF	
				IC121	8-759-509-17	IC XRU4053BCF	
				IC122	8-759-998-98	IC LM358D	
				IC123	8-759-998-98	IC LM358D	
				IC124	8-752-052-62	IC CXA1478S	

B

REF. NO.	PART NO.	DESCRIPTION	REMARK	REF. NO.	PART NO.	DESCRIPTION	REMARK
IC125	8-759-509-05	IC XRU4066BCF		Q138	8-729-907-26	TRANSISTOR IMX1	
IC126	8-759-509-17	IC XRU4053BCF		Q139	8-729-216-22	TRANSISTOR 2SA1162-G	
IC127	8-759-998-98	IC LM358D		Q140	8-729-120-28	TRANSISTOR 2SC1623-L5L6	
IC128	8-759-998-98	IC LM358D		Q141	8-729-120-28	TRANSISTOR 2SC1623-L5L6	
IC129	8-759-998-98	IC LM358D		Q142	8-729-120-28	TRANSISTOR 2SC1623-L5L6	
<COIL>				Q143	8-729-120-28	TRANSISTOR 2SC1623-L5L6	
L101	1-410-470-11	INDUCTOR 10UH		Q144	8-729-120-28	TRANSISTOR 2SC1623-L5L6	
L102	1-410-090-41	INDUCTOR 18MMH		Q145	8-729-120-28	TRANSISTOR 2SC1623-L5L6	
L103	1-412-002-31	INDUCTOR CHIP 4.7UH		Q146	8-729-255-12	TRANSISTOR 2SC2551-O	
L104	1-412-002-31	INDUCTOR CHIP 4.7UH		Q147	8-729-255-12	TRANSISTOR 2SC2551-O	
L105	1-412-002-31	INDUCTOR CHIP 4.7UH		Q148	8-729-216-22	TRANSISTOR 2SA1162-G	
L106	1-410-470-11	INDUCTOR 10UH		Q149	8-729-200-17	TRANSISTOR 2SA1091-O	
L107	1-410-470-11	INDUCTOR 10UH		Q150	8-729-120-28	TRANSISTOR 2SC1623-L5L6	
L112	1-408-419-00	INDUCTOR 68UH		Q151	8-729-216-22	TRANSISTOR 2SA1162-G	
L113	1-410-947-31	INDUCTOR CHIP 33UH		Q152	8-729-200-17	TRANSISTOR 2SA1091-O	
L114	1-410-947-31	INDUCTOR CHIP 33UH		Q153	8-729-120-28	TRANSISTOR 2SC1623-L5L6	
L115	1-410-947-31	INDUCTOR CHIP 33UH		Q154	8-729-216-22	TRANSISTOR 2SA1162-G	
L116	1-412-011-31	INDUCTOR CHIP 27UH		Q155	8-729-200-17	TRANSISTOR 2SA1091-O	
L117	1-412-011-31	INDUCTOR CHIP 27UH		Q157	8-729-326-11	TRANSISTOR 2SC2611	
L118	1-412-011-31	INDUCTOR CHIP 27UH		Q158	8-729-326-11	TRANSISTOR 2SC2611	
L250	1-410-997-31	INDUCTOR CHIP 2.2UH		Q159	8-729-326-11	TRANSISTOR 2SC2611	
L251	1-410-999-11	INDUCTOR CHIP 3.3UH		Q160	8-729-120-28	TRANSISTOR 2SC1623-L5L6	
L252	1-410-478-11	INDUCTOR 47UH		Q161	8-729-216-22	TRANSISTOR 2SA1162-G	
L300	1-410-482-31	INDUCTOR 100UH		Q164	8-729-901-01	TRANSISTOR DTC144EK	
<TRANSISTOR>				Q165	8-729-216-22	TRANSISTOR 2SA1162-G	
Q101	8-729-120-28	TRANSISTOR 2SC1623-L5L6		Q166	8-729-216-22	TRANSISTOR 2SA1162-G	
Q102	8-729-120-28	TRANSISTOR 2SC1623-L5L6		Q167	8-729-216-22	TRANSISTOR 2SA1162-G	
Q103	8-729-120-28	TRANSISTOR 2SC1623-L5L6		Q168	8-729-216-22	TRANSISTOR 2SA1162-G	
Q104	8-729-120-28	TRANSISTOR 2SC1623-L5L6		Q170	8-729-120-28	TRANSISTOR 2SC1623-L5L6	
Q105	8-729-120-28	TRANSISTOR 2SC1623-L5L6		Q171	8-729-120-28	TRANSISTOR 2SC1623-L5L6	
Q106	8-729-120-28	TRANSISTOR 2SC1623-L5L6		Q172	8-729-120-28	TRANSISTOR 2SC1623-L5L6	
Q107	8-729-120-28	TRANSISTOR 2SC1623-L5L6		Q173	8-729-216-22	TRANSISTOR 2SA1162-G	
Q108	8-729-216-22	TRANSISTOR 2SA1162-G		Q174	8-729-216-22	TRANSISTOR 2SA1162-G	
Q109	8-729-901-01	TRANSISTOR DTC144EK		Q175	8-729-216-22	TRANSISTOR 2SA1162-G	
Q112	8-729-120-28	TRANSISTOR 2SC1623-L5L6		Q176	8-729-216-22	TRANSISTOR 2SA1162-G	
Q113	8-729-120-28	TRANSISTOR 2SC1623-L5L6		Q177	8-729-120-28	TRANSISTOR 2SC1623-L5L6	
Q114	8-729-216-22	TRANSISTOR 2SA1162-G		Q178	8-729-120-28	TRANSISTOR 2SC1623-L5L6	
Q115	8-729-120-28	TRANSISTOR 2SC1623-L5L6		Q179	8-729-901-01	TRANSISTOR DTC144EK	
Q116	8-729-120-28	TRANSISTOR 2SC1623-L5L6		Q189	8-729-907-26	TRANSISTOR IMX1	
Q117	8-729-216-22	TRANSISTOR 2SA1162-G		Q190	8-729-216-22	TRANSISTOR 2SA1162-G	
Q118	8-729-120-28	TRANSISTOR 2SC1623-L5L6		Q191	8-729-120-28	TRANSISTOR 2SC1623-L5L6	
Q119	8-729-216-22	TRANSISTOR 2SA1162-G		Q192	8-729-120-28	TRANSISTOR 2SC1623-L5L6	
Q120	8-729-216-22	TRANSISTOR 2SA1162-G		Q193	8-729-120-28	TRANSISTOR 2SC1623-L5L6	
Q121	8-729-120-28	TRANSISTOR 2SC1623-L5L6		Q194	8-729-120-28	TRANSISTOR 2SC1623-L5L6	
Q122	8-729-216-22	TRANSISTOR 2SA1162-G		Q195	8-729-216-22	TRANSISTOR 2SA1162-G	
Q123	8-729-120-28	TRANSISTOR 2SC1623-L5L6		Q196	8-729-120-28	TRANSISTOR 2SC1623-L5L6	
Q124	8-729-216-22	TRANSISTOR 2SA1162-G		Q197	8-729-216-22	TRANSISTOR 2SA1162-G	
Q125	8-729-120-28	TRANSISTOR 2SC1623-L5L6		Q198	8-729-216-22	TRANSISTOR 2SA1162-G	
Q126	8-729-901-01	TRANSISTOR DTC144EK		Q199	8-729-216-22	TRANSISTOR 2SA1162-G	
Q127	8-729-216-22	TRANSISTOR 2SA1162-G		Q200	8-729-901-06	TRANSISTOR DTA144EK	
Q128	8-729-216-22	TRANSISTOR 2SA1162-G		Q201	8-729-216-22	TRANSISTOR 2SA1162-G	
Q129	8-729-901-01	TRANSISTOR DTC144EK		Q202	8-729-216-22	TRANSISTOR 2SA1162-G	
Q130	8-729-216-22	TRANSISTOR 2SA1162-G		Q203	8-729-216-22	TRANSISTOR 2SA1162-G	
Q131	8-729-120-28	TRANSISTOR 2SC1623-L5L6		Q204	8-729-216-22	TRANSISTOR 2SA1162-G	
Q132	8-729-216-22	TRANSISTOR 2SA1162-G		Q205	8-729-216-22	TRANSISTOR 2SA1162-G	
Q133	8-729-120-28	TRANSISTOR 2SC1623-L5L6		Q206	8-729-216-22	TRANSISTOR 2SA1162-G	
Q134	8-729-901-01	TRANSISTOR DTC144EK		Q208	8-729-216-22	TRANSISTOR 2SA1162-G	
Q135	8-729-120-28	TRANSISTOR 2SC1623-L5L6		Q209	8-729-255-12	TRANSISTOR 2SC2551-O	
Q136	8-729-907-26	TRANSISTOR IMX1		Q210	8-729-255-12	TRANSISTOR 2SC2551-O	
Q137	8-729-907-26	TRANSISTOR IMX1		Q211	8-729-255-12	TRANSISTOR 2SC2551-O	
				Q212	8-729-141-53	TRANSISTOR 2SK94-X2X3X4	
				Q299	8-729-120-28	TRANSISTOR 2SC1623-L5L6	



REF. NO.	PART NO.	DESCRIPTION	REMARK	REF. NO.	PART NO.	DESCRIPTION	REMARK
<RESISTOR>							
JR105	1-216-295-91	METAL GLAZE	0 5% 1/10W	R169	1-216-033-00	METAL GLAZE	220 5% 1/10W
JR110	1-216-295-91	METAL GLAZE	0 5% 1/10W	R170	1-216-089-91	METAL GLAZE	47K 5% 1/10W
JR133	1-216-295-91	METAL GLAZE	0 5% 1/10W	R171	1-216-053-00	METAL GLAZE	1.5K 5% 1/10W
JR138	1-216-295-91	METAL GLAZE	0 5% 1/10W	R172	1-216-043-00	METAL GLAZE	560 5% 1/10W
JR178	1-216-295-91	METAL GLAZE	0 5% 1/10W	R173	1-216-093-00	METAL GLAZE	68K 5% 1/10W
R101	1-216-089-91	METAL GLAZE	47K 5% 1/10W	R174	1-216-069-00	METAL GLAZE	6.8K 5% 1/10W
R102	1-216-025-00	METAL GLAZE	100 5% 1/10W	R175	1-216-057-00	METAL GLAZE	2.2K 5% 1/10W
R103	1-216-091-00	METAL GLAZE	56K 5% 1/10W	R176	1-216-065-00	METAL GLAZE	4.7K 5% 1/10W
R104	1-216-061-00	METAL GLAZE	3.3K 5% 1/10W	R177	1-216-073-00	METAL GLAZE	10K 5% 1/10W
R105	1-216-025-00	METAL GLAZE	100 5% 1/10W	R178	1-216-089-91	METAL GLAZE	47K 5% 1/10W
R106	1-216-065-00	METAL GLAZE	4.7K 5% 1/10W	R179	1-216-081-00	METAL GLAZE	22K 5% 1/10W
R107	1-216-025-00	METAL GLAZE	100 5% 1/10W	R180	1-216-679-11	METAL CHIP	15K 0.50% 1/10W
R108	1-216-113-00	METAL GLAZE	470K 5% 1/10W	R181	1-216-071-00	METAL GLAZE	8.2K 5% 1/10W
R109	1-216-065-00	METAL GLAZE	4.7K 5% 1/10W	R182	1-216-683-11	METAL CHIP	22K 0.50% 1/10W
R110	1-216-049-00	METAL GLAZE	1K 5% 1/10W	R183	1-216-691-11	METAL CHIP	47K 0.50% 1/10W
R111	1-216-063-00	METAL GLAZE	3.9K 5% 1/10W	R184	1-216-699-11	METAL CHIP	100K 0.50% 1/10W
R112	1-216-049-00	METAL GLAZE	1K 5% 1/10W	R185	1-216-073-00	METAL GLAZE	10K 5% 1/10W
R113	1-249-401-11	CARBON	47 5% 1/4W F	R186	1-216-113-00	METAL GLAZE	470K 5% 1/10W
R114	1-216-045-00	METAL GLAZE	680 5% 1/10W	R187	1-216-073-00	METAL GLAZE	10K 5% 1/10W
R115	1-216-061-00	METAL GLAZE	3.3K 5% 1/10W	R188	1-216-113-00	METAL GLAZE	470K 5% 1/10W
R117	1-216-073-00	METAL GLAZE	10K 5% 1/10W	R189	1-216-103-91	METAL GLAZE	180K 5% 1/10W
R118	1-216-025-00	METAL GLAZE	100 5% 1/10W	R190	1-216-107-00	METAL GLAZE	270K 5% 1/10W
R119	1-216-647-11	METAL CHIP	680 0.50% 1/10W	R191	1-216-097-00	METAL GLAZE	100K 5% 1/10W
R120	1-216-647-11	METAL CHIP	680 0.50% 1/10W	R192	1-216-103-91	METAL GLAZE	180K 5% 1/10W
R121	1-216-025-00	METAL GLAZE	100 5% 1/10W	R193	1-216-105-00	METAL GLAZE	220K 5% 1/10W
R122	1-216-083-00	METAL GLAZE	27K 5% 1/10W	R194	1-216-089-91	METAL GLAZE	47K 5% 1/10W
R123	1-216-073-00	METAL GLAZE	10K 5% 1/10W	R195	1-216-113-00	METAL GLAZE	470K 5% 1/10W
R124	1-216-073-00	METAL GLAZE	10K 5% 1/10W	R196	1-216-073-00	METAL GLAZE	10K 5% 1/10W
R125	1-216-083-00	METAL GLAZE	27K 5% 1/10W	R197	1-216-671-11	METAL CHIP	6.8K 0.50% 1/10W
R126	1-216-093-00	METAL GLAZE	68K 5% 1/10W	R198	1-216-049-00	METAL GLAZE	1K 5% 1/10W
R127	1-216-037-00	METAL GLAZE	330 5% 1/10W	R199	1-216-065-00	METAL GLAZE	4.7K 5% 1/10W
R128	1-216-083-00	METAL GLAZE	27K 5% 1/10W	R200	1-216-065-00	METAL GLAZE	4.7K 5% 1/10W
R129	1-216-067-00	METAL GLAZE	5.6K 5% 1/10W	R201	1-216-043-00	METAL GLAZE	560 5% 1/10W
R130	1-216-097-00	METAL GLAZE	100K 5% 1/10W	R202	1-216-033-00	METAL GLAZE	220 5% 1/10W
R131	1-216-089-91	METAL GLAZE	47K 5% 1/10W	R203	1-216-045-00	METAL GLAZE	680 5% 1/10W
R132	1-216-057-00	METAL GLAZE	2.2K 5% 1/10W	R204	1-216-073-00	METAL GLAZE	10K 5% 1/10W
R133	1-216-079-00	METAL GLAZE	18K 5% 1/10W	R205	1-216-073-00	METAL GLAZE	10K 5% 1/10W
R134	1-216-645-11	METAL CHIP	560 0.50% 1/10W	R206	1-216-043-00	METAL GLAZE	560 5% 1/10W
R135	1-216-645-11	METAL CHIP	560 0.50% 1/10W	R207	1-216-045-00	METAL GLAZE	680 5% 1/10W
R136	1-216-091-00	METAL GLAZE	56K 5% 1/10W	R208	1-216-671-11	METAL CHIP	6.8K 0.50% 1/10W
R137	1-216-045-00	METAL GLAZE	680 5% 1/10W	R209	1-216-043-00	METAL GLAZE	560 5% 1/10W
R138	1-216-657-11	METAL CHIP	1.8K 0.50% 1/10W	R210	1-216-033-00	METAL GLAZE	220 5% 1/10W
R139	1-216-079-00	METAL GLAZE	18K 5% 1/10W	R211	1-216-099-00	METAL GLAZE	120K 5% 1/10W
R140	1-216-653-11	METAL CHIP	1.2K 0.50% 1/10W	R212	1-216-065-00	METAL GLAZE	4.7K 5% 1/10W
R141	1-216-063-00	METAL GLAZE	3.9K 5% 1/10W	R213	1-216-043-00	METAL GLAZE	560 5% 1/10W
R142	1-216-073-00	METAL GLAZE	10K 5% 1/10W	R214	1-216-043-00	METAL GLAZE	560 5% 1/10W
R143	1-216-085-00	METAL GLAZE	33K 5% 1/10W	R215	1-216-127-11	METAL GLAZE	1.8M 5% 1/10W
R145	1-216-065-00	METAL GLAZE	4.7K 5% 1/10W	R216	1-216-043-00	METAL GLAZE	560 5% 1/10W
R146	1-216-037-00	METAL GLAZE	330 5% 1/10W	R217	1-216-033-00	METAL GLAZE	220 5% 1/10W
R147	1-216-089-91	METAL GLAZE	47K 5% 1/10W	R218	1-216-295-91	METAL GLAZE	0 5% 1/10W
R148	1-216-671-11	METAL CHIP	6.8K 0.50% 1/10W	R219	1-216-043-00	METAL GLAZE	560 5% 1/10W
R155	1-216-655-11	METAL CHIP	1.5K 0.50% 1/10W	R220	1-216-043-00	METAL GLAZE	560 5% 1/10W
R157	1-216-679-11	METAL CHIP	15K 0.50% 1/10W	R221	1-216-035-00	METAL GLAZE	270 5% 1/10W
R158	1-216-677-11	METAL CHIP	12K 0.50% 1/10W	R222	1-216-033-00	METAL GLAZE	220 5% 1/10W
R160	1-216-065-00	METAL GLAZE	4.7K 5% 1/10W	R223	1-216-073-00	METAL GLAZE	10K 5% 1/10W
R161	1-216-089-91	METAL GLAZE	47K 5% 1/10W	R224	1-216-073-00	METAL GLAZE	10K 5% 1/10W
R163	1-216-073-00	METAL GLAZE	10K 5% 1/10W	R225	1-216-095-00	METAL GLAZE	82K 5% 1/10W
R164	1-216-677-11	METAL CHIP	12K 0.50% 1/10W	R226	1-216-073-00	METAL GLAZE	10K 5% 1/10W
R165	1-216-107-00	METAL GLAZE	270K 5% 1/10W	R227	1-216-035-00	METAL GLAZE	270 5% 1/10W
R166	1-208-812-11	METAL CHIP	18K 0.50% 1/10W	R228	1-216-065-00	METAL GLAZE	4.7K 5% 1/10W
R167	1-216-635-11	METAL CHIP	220 0.50% 1/10W	R229	1-216-113-00	METAL GLAZE	470K 5% 1/10W
R168	1-216-103-91	METAL GLAZE	180K 5% 1/10W	R230	1-216-081-00	METAL GLAZE	22K 5% 1/10W
				R231	1-216-113-00	METAL GLAZE	470K 5% 1/10W

B

REF. NO.	PART NO.	DESCRIPTION	REMARK	REF. NO.	PART NO.	DESCRIPTION	REMARK
R232	1-216-105-00	METAL GLAZE 220K	5% 1/10W	R303	1-216-065-00	METAL GLAZE 4.7K	5% 1/10W
R233	1-216-073-00	METAL GLAZE 10K	5% 1/10W	R304	1-216-049-00	METAL GLAZE 1K	5% 1/10W
R234	1-216-041-00	METAL GLAZE 470	5% 1/10W	R305	1-216-049-00	METAL GLAZE 1K	5% 1/10W
R235	1-216-041-00	METAL GLAZE 470	5% 1/10W	R306	1-216-089-91	METAL GLAZE 47K	5% 1/10W
R236	1-216-077-00	METAL GLAZE 15K	5% 1/10W	R307	1-216-033-00	METAL GLAZE 220	5% 1/10W
R237	1-216-025-00	METAL GLAZE 100	5% 1/10W	R308	1-216-089-91	METAL GLAZE 47K	5% 1/10W
R238	1-216-065-00	METAL GLAZE 4.7K	5% 1/10W	R309	1-216-089-91	METAL GLAZE 47K	5% 1/10W
R239	1-216-065-00	METAL GLAZE 4.7K	5% 1/10W	R310	1-216-033-00	METAL GLAZE 220	5% 1/10W
R240	1-216-033-00	METAL GLAZE 220	5% 1/10W	R311	1-216-089-91	METAL GLAZE 47K	5% 1/10W
R241	1-216-073-00	METAL GLAZE 10K	5% 1/10W	R312	1-216-089-91	METAL GLAZE 47K	5% 1/10W
R242	1-216-051-00	METAL GLAZE 1.2K	5% 1/10W	R313	1-216-033-00	METAL GLAZE 220	5% 1/10W
R243	1-216-113-00	METAL GLAZE 470K	5% 1/10W	R314	1-216-089-91	METAL GLAZE 47K	5% 1/10W
R244	1-216-065-00	METAL GLAZE 4.7K	5% 1/10W	R315	1-216-113-00	METAL GLAZE 470K	5% 1/10W
R245	1-216-679-11	METAL CHIP 15K	0.50% 1/10W	R316	1-216-105-00	METAL GLAZE 220K	5% 1/10W
R246	1-216-103-91	METAL GLAZE 180K	5% 1/10W	R317	1-216-109-00	METAL GLAZE 330K	5% 1/10W
R247	1-216-093-00	METAL GLAZE 68K	5% 1/10W	R318	1-216-105-00	METAL GLAZE 220K	5% 1/10W
R248	1-216-095-00	METAL GLAZE 82K	5% 1/10W	R319	1-216-099-00	METAL GLAZE 120K	5% 1/10W
R249	1-216-109-00	METAL GLAZE 330K	5% 1/10W	R320	1-216-099-00	METAL GLAZE 120K	5% 1/10W
R250	1-216-101-00	METAL GLAZE 150K	5% 1/10W	R321	1-216-043-00	METAL GLAZE 560	5% 1/10W
R251	1-216-105-00	METAL GLAZE 220K	5% 1/10W	R322	1-216-109-00	METAL GLAZE 330K	5% 1/10W
R252	1-216-101-00	METAL GLAZE 150K	5% 1/10W	R323	1-216-109-00	METAL GLAZE 330K	5% 1/10W
R253	1-216-101-00	METAL GLAZE 150K	5% 1/10W	R324	1-216-109-00	METAL GLAZE 330K	5% 1/10W
R254	1-216-033-00	METAL GLAZE 220	5% 1/10W	R325	1-216-097-00	METAL GLAZE 100K	5% 1/10W
R255	1-216-061-00	METAL GLAZE 3.3K	5% 1/10W	R326	1-216-113-00	METAL GLAZE 470K	5% 1/10W
R256	1-216-107-00	METAL GLAZE 270K	5% 1/10W	R328	1-216-073-00	METAL GLAZE 10K	5% 1/10W
R258	1-216-041-00	METAL GLAZE 470	5% 1/10W	R329	1-216-107-00	METAL GLAZE 270K	5% 1/10W
R259	1-216-073-00	METAL GLAZE 10K	5% 1/10W	R330	1-216-105-00	METAL GLAZE 220K	5% 1/10W
R260	1-216-025-00	METAL GLAZE 100	5% 1/10W	R331	1-216-025-00	METAL GLAZE 100	5% 1/10W
R261	1-216-035-00	METAL GLAZE 270	5% 1/10W	R332	1-216-097-00	METAL GLAZE 100K	5% 1/10W
R262	1-216-097-00	METAL GLAZE 100K	5% 1/10W	R333	1-216-097-00	METAL GLAZE 100K	5% 1/10W
R263	1-216-029-00	METAL GLAZE 150	5% 1/10W	R334	1-216-025-00	METAL GLAZE 100	5% 1/10W
R264	1-216-065-00	METAL GLAZE 4.7K	5% 1/10W	R335	1-216-099-00	METAL GLAZE 120K	5% 1/10W
R265	1-216-067-00	METAL GLAZE 5.6K	5% 1/10W	R336	1-216-095-00	METAL GLAZE 82K	5% 1/10W
R266	1-216-073-00	METAL GLAZE 10K	5% 1/10W	R337	1-216-105-00	METAL GLAZE 220K	5% 1/10W
R267	1-216-073-00	METAL GLAZE 10K	5% 1/10W	R338	1-216-025-00	METAL GLAZE 100	5% 1/10W
R268	1-216-081-00	METAL GLAZE 22K	5% 1/10W	R339	1-216-099-00	METAL GLAZE 120K	5% 1/10W
R269	1-216-103-91	METAL GLAZE 180K	5% 1/10W	R340	1-216-095-00	METAL GLAZE 82K	5% 1/10W
R270	1-216-081-00	METAL GLAZE 22K	5% 1/10W	R341	1-216-105-00	METAL GLAZE 220K	5% 1/10W
R271	1-216-025-00	METAL GLAZE 100	5% 1/10W	R342	1-216-047-00	METAL GLAZE 820	5% 1/10W
R272	1-216-103-91	METAL GLAZE 180K	5% 1/10W	R343	1-216-053-00	METAL GLAZE 1.5K	5% 1/10W
R273	1-216-113-00	METAL GLAZE 470K	5% 1/10W	R344	1-216-664-11	METAL CHIP 3.6K	0.50% 1/10W
R275	1-216-081-00	METAL GLAZE 22K	5% 1/10W	R345	1-216-661-11	METAL CHIP 2.7K	0.50% 1/10W
R276	1-216-037-00	METAL GLAZE 330	5% 1/10W	R346	1-216-105-00	METAL GLAZE 220K	5% 1/10W
R277	1-216-049-00	METAL GLAZE 1K	5% 1/10W	R348	1-216-061-00	METAL GLAZE 3.3K	5% 1/10W
R278	1-216-059-00	METAL GLAZE 2.7K	5% 1/10W	R349	1-216-650-11	METAL CHIP 910	0.50% 1/10W
R280	1-216-061-00	METAL GLAZE 3.3K	5% 1/10W	R350	1-216-653-11	METAL CHIP 1.2K	0.50% 1/10W
R281	1-216-061-00	METAL GLAZE 3.3K	5% 1/10W	R351	1-216-650-11	METAL CHIP 910	0.50% 1/10W
R282	1-216-037-00	METAL GLAZE 330	5% 1/10W	R352	1-216-653-11	METAL CHIP 1.2K	0.50% 1/10W
R283	1-216-049-00	METAL GLAZE 1K	5% 1/10W	R353	1-216-650-11	METAL CHIP 910	0.50% 1/10W
R284	1-216-059-00	METAL GLAZE 2.7K	5% 1/10W	R354	1-216-653-11	METAL CHIP 1.2K	0.50% 1/10W
R286	1-216-061-00	METAL GLAZE 3.3K	5% 1/10W	R355	1-216-113-00	METAL GLAZE 470K	5% 1/10W
R287	1-216-061-00	METAL GLAZE 3.3K	5% 1/10W	R356	1-216-113-00	METAL GLAZE 470K	5% 1/10W
R288	1-216-037-00	METAL GLAZE 330	5% 1/10W	R357	1-216-095-00	METAL GLAZE 82K	5% 1/10W
R289	1-216-049-00	METAL GLAZE 1K	5% 1/10W	R358	1-216-113-00	METAL GLAZE 470K	5% 1/10W
R290	1-216-059-00	METAL GLAZE 2.7K	5% 1/10W	R359	1-216-081-00	METAL GLAZE 22K	5% 1/10W
R292	1-216-061-00	METAL GLAZE 3.3K	5% 1/10W	R360	1-216-089-91	METAL GLAZE 47K	5% 1/10W
R293	1-216-061-00	METAL GLAZE 3.3K	5% 1/10W	R363	1-216-069-00	METAL GLAZE 6.8K	5% 1/10W
R295	1-216-057-00	METAL GLAZE 2.2K	5% 1/10W	R364	1-216-073-00	METAL GLAZE 10K	5% 1/10W
R296	1-216-659-11	METAL CHIP 2.2K	0.50% 1/10W	R365	1-216-073-00	METAL GLAZE 10K	5% 1/10W
R297	1-216-659-11	METAL CHIP 2.2K	0.50% 1/10W	R368	1-216-055-00	METAL GLAZE 1.8K	5% 1/10W
R298	1-216-065-00	METAL GLAZE 4.7K	5% 1/10W	R369	1-216-248-00	METAL GLAZE 120K	5% 1/8W
R300	1-216-065-00	METAL GLAZE 4.7K	5% 1/10W	R370	1-216-115-00	METAL GLAZE 560K	5% 1/10W
R301	1-216-065-00	METAL GLAZE 4.7K	5% 1/10W	R371	1-216-067-00	METAL GLAZE 5.6K	5% 1/10W
R302	1-216-113-00	METAL GLAZE 470K	5% 1/10W				

B

REF. NO.	PART NO.	DESCRIPTION	REMARK	REF. NO.	PART NO.	DESCRIPTION	REMARK
R372	1-216-115-00	METAL GLAZE	560K 5% 1/10W	R1045	1-216-125-00	METAL GLAZE	1.5M 5% 1/10W
R374	1-216-115-00	METAL GLAZE	560K 5% 1/10W	R1046	1-216-689-11	METAL CHIP	39K 0.50% 1/10W
R375	1-216-683-11	METAL CHIP	22K 0.50% 1/10W	R1047	1-216-065-00	METAL GLAZE	4.7K 5% 1/10W
R376	1-216-663-11	METAL CHIP	3.3K 0.50% 1/10W	R1048	1-216-049-00	METAL GLAZE	1K 5% 1/10W
R378	1-216-025-00	METAL GLAZE	100 5% 1/10W	R1049	1-216-085-00	METAL GLAZE	33K 5% 1/10W
R379	1-216-641-11	METAL CHIP	390 0.50% 1/10W	R1050	1-216-059-00	METAL GLAZE	2.7K 5% 1/10W
R380	1-208-799-11	METAL CHIP	5.1K 0.50% 1/10W	R1051	1-216-105-00	METAL GLAZE	220K 5% 1/10W
R381	1-216-089-91	METAL GLAZE	47K 5% 1/10W	R1053	1-216-091-00	METAL GLAZE	56K 5% 1/10W
R382	1-216-025-00	METAL GLAZE	100 5% 1/10W	R1054	1-216-093-00	METAL GLAZE	68K 5% 1/10W
R383	1-216-641-11	METAL CHIP	390 0.50% 1/10W	R1055	1-216-097-00	METAL GLAZE	100K 5% 1/10W
R384	1-208-799-11	METAL CHIP	5.1K 0.50% 1/10W	R1056	1-216-037-00	METAL GLAZE	330 5% 1/10W
R385	1-216-117-00	METAL GLAZE	680K 5% 1/10W	R1057	1-216-065-00	METAL GLAZE	4.7K 5% 1/10W
R386	1-216-025-00	METAL GLAZE	100 5% 1/10W	R1058	1-216-109-00	METAL GLAZE	330K 5% 1/10W
R387	1-216-641-11	METAL CHIP	390 0.50% 1/10W	R1059	1-216-109-00	METAL GLAZE	330K 5% 1/10W
R388	1-208-799-11	METAL CHIP	5.1K 0.50% 1/10W	R1060	1-216-109-00	METAL GLAZE	330K 5% 1/10W
R389	1-216-089-91	METAL GLAZE	47K 5% 1/10W	R1061	1-216-109-00	METAL GLAZE	330K 5% 1/10W
R390	1-216-105-00	METAL GLAZE	220K 5% 1/10W	R1062	1-216-103-91	METAL GLAZE	180K 5% 1/10W
R391	1-216-081-00	METAL GLAZE	22K 5% 1/10W	R1063	1-216-103-91	METAL GLAZE	180K 5% 1/10W
R392	1-216-113-00	METAL GLAZE	470K 5% 1/10W	R1064	1-216-103-91	METAL GLAZE	180K 5% 1/10W
R393	1-216-085-00	METAL GLAZE	33K 5% 1/10W	R1065	1-216-103-91	METAL GLAZE	180K 5% 1/10W
R394	1-216-113-00	METAL GLAZE	470K 5% 1/10W	R1066	1-216-073-00	METAL GLAZE	10K 5% 1/10W
R397	1-249-437-11	CARBON	47K 5% 1/4W F	R1067	1-216-073-00	METAL GLAZE	10K 5% 1/10W
R398	1-249-434-11	CARBON	27K 5% 1/4W F	R1068	1-216-049-00	METAL GLAZE	1K 5% 1/10W
R399	1-216-073-00	METAL GLAZE	10K 5% 1/10W	R1069	1-216-133-00	METAL GLAZE	3.3M 5% 1/10W
R1001	1-216-073-00	METAL GLAZE	10K 5% 1/10W	R1070	1-216-085-00	METAL GLAZE	33K 5% 1/10W
R1002	1-216-047-00	METAL GLAZE	820 5% 1/10W	R1071	1-216-113-00	METAL GLAZE	470K 5% 1/10W
R1003	1-216-055-00	METAL GLAZE	1.8K 5% 1/10W	R1072	1-216-099-00	METAL GLAZE	120K 5% 1/10W
R1004	1-216-061-00	METAL GLAZE	3.3K 5% 1/10W	R1073	1-216-131-11	METAL GLAZE	2.7M 5% 1/10W
R1005	1-216-047-00	METAL GLAZE	820 5% 1/10W	R1075	1-216-065-00	METAL GLAZE	4.7K 5% 1/10W
R1006	1-216-055-00	METAL GLAZE	1.8K 5% 1/10W	R1076	1-216-101-00	METAL GLAZE	150K 5% 1/10W
R1007	1-216-061-00	METAL GLAZE	3.3K 5% 1/10W	R1077	1-216-103-91	METAL GLAZE	180K 5% 1/10W
R1008	1-216-047-00	METAL GLAZE	820 5% 1/10W	R1079	1-216-131-11	METAL GLAZE	2.7M 5% 1/10W
R1009	1-216-053-00	METAL GLAZE	1.5K 5% 1/10W	R1080	1-216-097-00	METAL GLAZE	100K 5% 1/10W
R1010	1-216-061-00	METAL GLAZE	3.3K 5% 1/10W	R1081	1-216-097-00	METAL GLAZE	100K 5% 1/10W
R1011	1-216-033-00	METAL GLAZE	220 5% 1/10W	R1082	1-216-105-00	METAL GLAZE	220K 5% 1/10W
R1012	1-216-051-00	METAL GLAZE	1.2K 5% 1/10W	R1083	1-216-065-00	METAL GLAZE	4.7K 5% 1/10W
R1013	1-216-051-00	METAL GLAZE	1.2K 5% 1/10W	R1084	1-216-063-00	METAL GLAZE	3.9K 5% 1/10W
R1014	1-216-246-91	METAL GLAZE	100K 5% 1/8W	R1086	1-216-073-00	METAL GLAZE	10K 5% 1/10W
R1015	1-216-033-00	METAL GLAZE	220 5% 1/10W	R1087	1-216-121-00	METAL GLAZE	1M 5% 1/10W
R1016	1-216-089-91	METAL GLAZE	47K 5% 1/10W	R1088	1-216-047-00	METAL GLAZE	820 5% 1/10W
R1017	1-216-045-00	METAL GLAZE	680 5% 1/10W	R1090	1-216-049-00	METAL GLAZE	1K 5% 1/10W
R1018	1-216-043-00	METAL GLAZE	560 5% 1/10W	R1091	1-216-049-00	METAL GLAZE	1K 5% 1/10W
R1019	1-216-033-00	METAL GLAZE	220 5% 1/10W	R1092	1-216-049-00	METAL GLAZE	1K 5% 1/10W
R1020	1-216-089-91	METAL GLAZE	47K 5% 1/10W	R1093	1-216-121-00	METAL GLAZE	1M 5% 1/10W
R1021	1-216-045-00	METAL GLAZE	680 5% 1/10W	R1094	1-216-075-00	METAL GLAZE	12K 5% 1/10W
R1022	1-216-025-00	METAL GLAZE	100 5% 1/10W	R1095	1-216-075-00	METAL GLAZE	12K 5% 1/10W
R1023	1-216-073-00	METAL GLAZE	10K 5% 1/10W	R1096	1-216-075-00	METAL GLAZE	12K 5% 1/10W
R1024	1-216-025-00	METAL GLAZE	100 5% 1/10W	R1200	1-216-699-11	METAL CHIP	100K 0.50% 1/10W
R1025	1-216-033-00	METAL GLAZE	220 5% 1/10W	R1201	1-218-754-11	METAL CHIP	120K 0.50% 1/10W
R1026	1-216-061-00	METAL GLAZE	3.3K 5% 1/10W	R1207	1-216-061-00	METAL GLAZE	3.3K 5% 1/10W
R1027	1-216-101-00	METAL GLAZE	150K 5% 1/10W	R1208	1-216-065-00	METAL GLAZE	4.7K 5% 1/10W
R1028	1-216-033-00	METAL GLAZE	220 5% 1/10W	R1220	1-216-055-00	METAL GLAZE	1.8K 5% 1/10W
R1029	1-216-061-00	METAL GLAZE	3.3K 5% 1/10W	R1221	1-216-055-00	METAL GLAZE	1.8K 5% 1/10W
R1030	1-216-089-91	METAL GLAZE	47K 5% 1/10W	R1222	1-216-055-00	METAL GLAZE	1.8K 5% 1/10W
R1031	1-216-033-00	METAL GLAZE	220 5% 1/10W	R1223	1-216-689-11	METAL GLAZE	39K 5% 1/10W
R1032	1-216-061-00	METAL GLAZE	3.3K 5% 1/10W	R1225	1-215-876-00	METAL OXIDE	15K 5% 1W F
R1033	1-216-081-00	METAL GLAZE	22K 5% 1/10W	R1226	1-215-876-00	METAL OXIDE	15K 5% 1W F
R1035	1-216-073-00	METAL GLAZE	10K 5% 1/10W	R1227	1-215-876-00	METAL OXIDE	15K 5% 1W F
R1036	1-216-089-91	METAL GLAZE	47K 5% 1/10W	R1228	1-249-421-11	CARBON	2.2K 5% 1/4W F
R1038	1-216-081-00	METAL GLAZE	22K 5% 1/10W	R1229	1-249-421-11	CARBON	2.2K 5% 1/4W F
R1040	1-216-025-00	METAL GLAZE	100 5% 1/10W	R1230	1-249-421-11	CARBON	2.2K 5% 1/4W F
R1042	1-216-047-00	METAL GLAZE	820 5% 1/10W	R1231	1-216-029-00	METAL GLAZE	150 5% 1/10W
R1043	1-216-057-00	METAL GLAZE	2.2K 5% 1/10W	R1232	1-216-029-00	METAL GLAZE	150 5% 1/10W
R1044	1-216-061-00	METAL GLAZE	3.3K 5% 1/10W				

The components identified by shading and mark Δ are critical for safety. Replace only with part number specified.

B P

REF. NO.	PART NO.	DESCRIPTION			REMARK	REF. NO.	PART NO.	DESCRIPTION			REMARK
R1233	1-216-029-00	METAL GLAZE	150	5%	1/10W	R1351	1-216-073-00	METAL GLAZE	10K	5%	1/10W
R1234	1-216-029-00	METAL GLAZE	150	5%	1/10W	R1352	1-216-073-00	METAL GLAZE	10K	5%	1/10W
R1235	1-216-029-00	METAL GLAZE	150	5%	1/10W	R1353	1-216-115-00	METAL GLAZE	560K	5%	1/10W
R1236	1-216-029-00	METAL GLAZE	150	5%	1/10W	R1371	1-216-057-00	METAL GLAZE	2.2K	5%	1/10W
R1237	1-249-419-11	CARBON	1.5K	5%	1/4W F	R1372	1-216-057-00	METAL GLAZE	2.2K	5%	1/10W
R1238	1-249-419-11	CARBON	1.5K	5%	1/4W F	R1373	1-216-057-00	METAL GLAZE	2.2K	5%	1/10W
R1239	1-249-419-11	CARBON	1.5K	5%	1/4W F	R1392	1-216-089-91	METAL GLAZE	47K	5%	1/10W
R1270	1-216-079-00	METAL GLAZE	18K	5%	1/10W	R1393	1-216-095-00	METAL GLAZE	82K	5%	1/10W
R1271	1-216-057-00	METAL GLAZE	2.2K	5%	1/10W						
R1280	1-216-109-00	METAL GLAZE	330K	5%	1/10W			<VARIABLE RESISTOR>			
R1288	1-216-105-00	METAL GLAZE	220K	5%	1/10W	RV101	1-241-763-11	RES. ADJ. CERMET	4.7K		
R1290	1-216-071-00	METAL GLAZE	8.2K	5%	1/10W	RV102	1-241-763-11	RES. ADJ. CERMET	4.7K		
R1291	1-216-081-00	METAL GLAZE	22K	5%	1/10W	RV103	1-241-759-21	RES. ADJ. CARBON	220		
R1294	1-216-069-00	METAL GLAZE	6.8K	5%	1/10W	RV104	1-241-759-21	RES. ADJ. CARBON	220		
R1295	1-216-109-00	METAL GLAZE	330K	5%	1/10W	RV105	1-241-761-11	RES. ADJ. CARBON	1K		
R1296	1-216-095-00	METAL GLAZE	82K	5%	1/10W	RV106	1-241-761-11	RES. ADJ. CARBON	1K		
R1297	1-216-071-00	METAL GLAZE	8.2K	5%	1/10W	RV107	1-241-761-11	RES. ADJ. CARBON	1K		
R1298	1-216-071-00	METAL GLAZE	8.2K	5%	1/10W	RV108	1-241-630-11	RES. ADJ. CARBON	10K		
R1299	1-216-071-00	METAL GLAZE	8.2K	5%	1/10W	RV109	1-241-765-11	RES. ADJ. CERMET	22K		
R1300	1-216-089-91	METAL GLAZE	47K	5%	1/10W	RV110	1-241-630-11	RES. ADJ. CARBON	10K		
R1301	1-216-065-00	METAL GLAZE	4.7K	5%	1/10W	RV111	1-241-630-11	RES. ADJ. CARBON	10K		
R1302	1-216-113-00	METAL GLAZE	470K	5%	1/10W	RV112	1-238-019-11	RES. ADJ. CARBON	47K		
R1303	1-216-113-00	METAL GLAZE	470K	5%	1/10W	RV113	1-238-019-11	RES. ADJ. CARBON	47K		
R1304	1-216-091-00	METAL GLAZE	56K	5%	1/10W	RV114	1-238-019-11	RES. ADJ. CARBON	47K		
R1305	1-216-093-00	METAL GLAZE	68K	5%	1/10W	RV115	1-241-765-11	RES. ADJ. CARBON	22K		
R1306	1-216-063-00	METAL GLAZE	3.9K	5%	1/10W	RV116	1-241-765-11	RES. ADJ. CARBON	22K		
R1307	1-216-041-00	METAL GLAZE	470	5%	1/10W	RV118	1-241-765-11	RES. ADJ. CARBON	22K		
R1308	1-216-041-00	METAL GLAZE	470	5%	1/10W	RV119	1-241-765-11	RES. ADJ. CARBON	22K		
R1309	1-216-063-00	METAL GLAZE	3.9K	5%	1/10W	RV120	1-241-765-11	RES. ADJ. CARBON	22K		
R1310	1-216-119-00	METAL GLAZE	820K	5%	1/10W	RV121	1-241-765-11	RES. ADJ. CARBON	22K		
R1313	1-216-101-00	METAL GLAZE	150K	5%	1/10W	RV122	1-241-765-11	RES. ADJ. CARBON	22K		
R1314	1-216-053-00	METAL GLAZE	1.5K	5%	1/10W	RV123	1-241-628-11	RES. ADJ. CARBON	2.2K		
R1315	1-216-077-00	METAL GLAZE	15K	5%	1/10W	RV124	1-241-761-11	RES. ADJ. CARBON	1K		
R1320	1-216-083-00	METAL GLAZE	27K	5%	1/10W	RV125	1-241-761-11	RES. ADJ. CARBON	1K		
R1321	1-216-093-00	METAL GLAZE	68K	5%	1/10W	RV205	1-241-765-11	RES. ADJ. CARBON	22K		
R1322	1-216-037-00	METAL GLAZE	330	5%	1/10W			<MODULE>			
R1323	1-216-057-00	METAL GLAZE	2.2K	5%	1/10W	SEP101	1-808-654-11	MODULE			
R1324	1-216-121-00	METAL GLAZE	1M	5%	1/10W			<CRYSTAL>			
R1325	1-216-085-00	METAL GLAZE	33K	5%	1/10W	X101	1-527-722-00	OSCILLATOR, CRYSTAL			
R1326	1-216-065-00	METAL GLAZE	4.7K	5%	1/10W	X102	1-577-259-11	VIBRATOR, CRYSTAL			
R1327	1-216-099-00	METAL GLAZE	120K	5%	1/10W			*****			
R1328	1-216-099-00	METAL GLAZE	120K	5%	1/10W			*A-1195-048-A P BOARD, COMPLETE			
R1329	1-216-093-00	METAL GLAZE	68K	5%	1/10W			*****			
R1330	1-216-063-00	METAL GLAZE	3.9K	5%	1/10W			<CAPACITOR>			
R1331	1-216-051-00	METAL GLAZE	1.2K	5%	1/10W	C801	1-126-104-11	ELECT	470MF	20%	35V
R1332	1-216-057-00	METAL GLAZE	2.2K	5%	1/10W	C802	1-162-318-11	CERAMIC	0.001MF	10%	500V
R1333	1-216-057-00	METAL GLAZE	2.2K	5%	1/10W	C803	1-102-228-00	CERAMIC	470PF	10%	500V
R1334	1-216-055-00	METAL GLAZE	1.8K	5%	1/10W	C804	1-123-935-00	ELECT	33MF	20%	160V
R1335	1-216-035-00	METAL GLAZE	270	5%	1/10W	C806	1-124-480-11	ELECT	470MF	20%	25V
R1336	1-216-089-91	METAL GLAZE	47K	5%	1/10W	C807	1-102-228-00	CERAMIC	470PF	10%	500V
R1337	1-216-113-00	METAL GLAZE	470K	5%	1/10W	C808	1-106-367-00	MYLAR	0.01MF	10%	100V
R1338	1-216-049-00	METAL GLAZE	1K	5%	1/10W	C809	1-106-375-12	MYLAR	0.022MF	10%	100V
R1339	1-216-097-00	METAL GLAZE	100K	5%	1/10W	C810	1-162-318-11	CERAMIC	0.001MF	10%	500V
R1340	1-216-097-00	METAL GLAZE	100K	5%	1/10W	C811	Δ 1-137-544-91	FILM	0.01MF	3%	600V
R1341	1-216-111-00	METAL GLAZE	390K	5%	1/10W	C812	Δ 1-137-545-91	FILM	0.013MF	3%	600V
R1342	1-216-694-11	METAL CHIP	62K	0.50%	1/10W						
R1343	1-216-121-00	METAL GLAZE	1M	5%	1/10W						
R1344	1-216-073-00	METAL GLAZE	10K	5%	1/10W						
R1345	1-216-055-00	METAL GLAZE	1.8K	5%	1/10W						
R1346	1-216-047-00	METAL GLAZE	820	5%	1/10W						
R1347	1-216-073-00	METAL GLAZE	10K	5%	1/10W						
R1348	1-216-073-00	METAL GLAZE	10K	5%	1/10W						
R1349	1-216-073-00	METAL GLAZE	10K	5%	1/10W						
R1350	1-216-073-00	METAL GLAZE	10K	5%	1/10W						

The components identified by shading and mark Δ are critical for safety. Replace only with part number specified.

P **FA** **QA**

REF.NO.	PART NO.	DESCRIPTION	REMARK
C813	1-106-385-00	MYLAR 0.056MF	5% 200V
C814	1-106-383-00	MYLAR 0.047MF	10% 100V
C815	1-124-916-11	ELECT 22MF	20% 50V
C816	1-124-798-11	ELECT 1MF	20% 160V
C817	1-130-800-00	FILM 2.2MF	10% 250V
C818	1-102-228-00	CERAMIC 470PF	10% 500V
C819	1-162-116-00	CERAMIC 680PF	10% 2KV
C820	1-162-116-00	CERAMIC 680PF	10% 2KV
C821	1-162-116-00	CERAMIC 680PF	10% 2KV
C825	1-123-024-21	ELECT 33MF	160V
C880	1-163-031-11	CERAMIC CHIP 0.01MF	50V
<CONNECTOR>			
CN801	1-564-595-11	PLUG, CONNECTOR 14P	
CN802	*1-508-766-00	PIN, CONNECTOR (5MM PITCH) 4P	
CN803	*1-564-508-11	PLUG, CONNECTOR 5P	
CN805	*1-560-123-00	PLUG, CONNECTOR (2.5MM) 3P	
<DIODE>			
D801	8-719-302-43	DIODE EL1Z	
D802	8-719-302-43	DIODE EL1Z	
D803	8-719-302-43	DIODE EL1Z	
D804	8-719-979-85	DIODE EGP20G	
D805	8-719-302-43	DIODE EL1Z	
D806	8-719-302-43	DIODE EL1Z	
D807	8-719-105-99	DIODE RD6.2M-B1	
D808	8-719-018-72	THYRISTOR CRO2AM-4TB	
D809	8-719-908-03	DIODE GP08D	
D810	8-719-908-03	DIODE GP08D	
D811	8-719-908-03	DIODE GP08D	
D813	8-719-302-43	DIODE EL1Z	
<COIL>			
L802	1-459-442-00	COIL (WITH CORE)	
L803	1-422-613-11	COIL, AIR CORE	
L804	1-459-109-00	COIL, DUST CORE	
L805	1-460-225-11	COIL, HORIZONTAL LINEARITY	
L806	1-414-098-11	MICRO INDUCTOR 10MMH	
L807	1-414-098-11	MICRO INDUCTOR 10MMH	
L810	1-412-529-11	INDUCTOR 22UH	
<NEON LAMP>			
NL801	1-519-108-99	LAMP, NEON	
<TRANSISTOR>			
Q801	8-729-195-82	TRANSISTOR 2SC2958-L	
Q802	8-729-201-62	TRANSISTOR 2SC2555-2	
	*4-043-154-01	HOLDER, IC; Q802	
	4-382-854-01	SCREW (M3X8), P, SW (+); Q802	
	4-879-937-00	SHEET, MICA; Q802	
Q803	8-729-906-24	TRANSISTOR 2SD835	
<RESISTOR>			
R801	1-249-383-11	CARBON 1.5 5%	1/4W F
R802	1-249-377-11	CARBON 0.47 5%	1/4W F
R803	1-216-049-00	METAL GLAZE 1K 5%	1/10W
R804	1-249-419-11	CARBON 1.5K 5%	1/4W F
R805	1-215-892-11	METAL OXIDE 1K 5%	2W F

REF.NO.	PART NO.	DESCRIPTION	REMARK
R807	1-216-425-11	METAL OXIDE 56 5%	1W F
R808	1-202-846-00	SOLID 470K 20%	1/2W
R809	1-216-089-91	METAL GLAZE 47K 5%	1/10W
R810	1-249-421-11	CARBON 2.2K 5%	1/4W F
R811	1-216-049-00	METAL GLAZE 1K 5%	1/10W
R812	1-249-439-11	CARBON 68K 5%	1/4W F
R813	1-249-414-11	CARBON 560 5%	1/4W F
R814	1-249-377-11	CARBON 0.47 5%	1/4W F
<VARIABLE RESISTOR>			
RV801	1-223-102-00	RES, ADJ, WIREWOUND 120	
<TRANSFORMER>			
T801	1-437-082-31	HDT	
T802	Δ 1-439-526-12	TRANSFORMER ASSY, FLYBACK	

	*A-1241-070-A	FA BOARD, COMPLETE	*****
<CAPACITOR>			
C601	1-136-185-00	FILM 0.22MF	20% 250V
<CONNECTOR>			
CN601	*1-580-689-11	PIN, CONNECTOR (PC BOARD) 4P	
CN602	*1-508-765-00	PIN, CONNECTOR (5MM PITCH) 3P	
CN603	*1-564-507-11	PLUG, CONNECTOR 4P	
<FUSE>			
F601	Δ 1-576-230-11	FUSE (H.B.C.) (3.15A/250V)	
	1-533-223-11	CLIP, FUSE	
<RESISTOR>			
R602	1-214-945-00	METAL 2.2M 5%	1/2W
<SWITCH>			
S601	1-692-050-11	SWITCH, PUSH (AC POWER) (1KEY)	

	*A-1275-121-A	QA BOARD, COMPLETE	*****
	1-537-408-21	TERMINAL BOARD B, INPUT/OUTPUT	
	1-537-410-11	TERMINAL BOARD A, INPUT/OUTPUT	
<CAPACITOR>			
C401	1-124-234-00	ELECT 22MF	20% 16V
C402	1-124-234-00	ELECT 22MF	20% 16V
C403	1-124-234-00	ELECT 22MF	20% 16V
C404	1-124-234-00	ELECT 22MF	20% 16V
C405	1-124-234-00	ELECT 22MF	20% 16V
C406	1-124-234-00	ELECT 22MF	20% 16V
C407	1-124-234-00	ELECT 22MF	20% 16V
C408	1-124-463-00	ELECT 0.1MF	20% 50V
C409	1-124-234-00	ELECT 22MF	20% 16V
C410	1-124-234-00	ELECT 22MF	20% 16V
C411	1-124-234-00	ELECT 22MF	20% 16V

QA

REF. NO.	PART NO.	DESCRIPTION	REMARK	REF. NO.	PART NO.	DESCRIPTION	REMARK
C412	1-124-234-00	ELECT	22MF	20%	16V		
C413	1-124-234-00	ELECT	22MF	20%	16V		
C414	1-126-157-11	ELECT	10MF	20%	16V		
C415	1-126-157-11	ELECT	10MF	20%	16V		
C416	1-126-157-11	ELECT	10MF	20%	16V		
C417	1-126-157-11	ELECT	10MF	20%	16V		
C418	1-126-157-11	ELECT	10MF	20%	16V		
C419	1-126-157-11	ELECT	10MF	20%	16V		
C420	1-126-157-11	ELECT	10MF	20%	16V		
C421	1-102-125-00	CERAMIC	0.0047MF	10%	50V		
C422	1-124-464-11	ELECT	0.22MF	20%	50V		
C423	1-126-157-11	ELECT	10MF	20%	16V		
C424	1-126-157-11	ELECT	10MF	20%	16V		
C425	1-108-634-11	MYLAR	0.047MF	10%	100V		
C426	1-128-499-11	ELECT	220MF	20%	16V		
C427	1-128-499-11	ELECT	220MF	20%	16V		
C428	1-124-589-11	ELECT	47MF	20%	16V		
C429	1-124-234-00	ELECT	22MF	20%	16V		
C430	1-163-033-00	CERAMIC CHIP	0.022MF		50V		
C431	1-124-234-00	ELECT	22MF	20%	16V		
C432	1-163-033-00	CERAMIC CHIP	0.022MF		50V		
C433	1-124-234-00	ELECT	22MF	20%	16V		
C434	1-163-033-00	CERAMIC CHIP	0.022MF		50V		
C435	1-124-234-00	ELECT	22MF	20%	16V		
C436	1-163-033-00	CERAMIC CHIP	0.022MF		50V		
C437	1-163-033-00	CERAMIC CHIP	0.022MF		50V		
C438	1-124-234-00	ELECT	22MF	20%	16V		
C439	1-163-033-00	CERAMIC CHIP	0.022MF		50V		
C440	1-163-033-00	CERAMIC CHIP	0.022MF		50V		
C441	1-124-234-00	ELECT	22MF	20%	16V		
C442	1-163-033-00	CERAMIC CHIP	0.022MF		50V		
C443	1-163-033-00	CERAMIC CHIP	0.022MF		50V		
C444	1-163-033-00	CERAMIC CHIP	0.022MF		50V		
C445	1-163-031-11	CERAMIC CHIP	0.01MF		50V		
C446	1-163-031-11	CERAMIC CHIP	0.01MF		50V		
C447	1-126-301-11	ELECT	1MF	20%	50V		
C448	1-124-234-00	ELECT	22MF	20%	16V		
C449	1-163-031-11	CERAMIC CHIP	0.01MF		50V		
C450	1-124-234-00	ELECT	22MF	20%	16V		
C451	1-163-033-00	CERAMIC CHIP	0.022MF		50V		
C452	1-128-499-11	ELECT	220MF	20%	16V		
C453	1-124-234-00	ELECT	22MF	20%	16V		
C454	1-128-499-11	ELECT	220MF	20%	16V		
C460	1-126-301-11	ELECT	1MF	20%	50V		
C461	1-126-301-11	ELECT	1MF	20%	50V		
C462	1-126-301-11	ELECT	1MF	20%	50V		
C464	1-163-031-11	CERAMIC CHIP	0.01MF		50V		
C465	1-163-031-11	CERAMIC CHIP	0.01MF		50V		
C466	1-163-031-11	CERAMIC CHIP	0.01MF		50V		
C467	1-163-031-11	CERAMIC CHIP	0.01MF		50V		
C475	1-163-031-11	CERAMIC CHIP	0.01MF		50V		
<CONNECTOR>							
CN401	1-506-494-11	PIN, CONNECTOR	15P				
CN402	*1-564-518-11	PLUG, CONNECTOR	3P				
CN403	*1-580-690-11	PIN, CONNECTOR (PC BOARD)	2P				
CN404	*1-564-520-11	PLUG, CONNECTOR	5P				
<DIODE>							
D401	8-719-404-46	DIODE	MA110				
D402	8-719-404-46	DIODE	MA110				
D403	8-719-110-09	DIODE	RD8.2ESB3				
D404	8-719-404-46	DIODE	MA110				
D405	8-719-404-46	DIODE	MA110				
D406	8-719-404-46	DIODE	MA110				
D407	8-719-404-46	DIODE	MA110				
D408	8-719-404-46	DIODE	MA110				
D409	8-719-404-46	DIODE	MA110				
D410	8-719-404-46	DIODE	MA110				
D411	8-719-404-46	DIODE	MA110				
D412	8-719-404-46	DIODE	MA110				
D413	8-719-404-46	DIODE	MA110				
D414	8-719-404-46	DIODE	MA110				
D415	8-719-404-46	DIODE	MA110				
D416	8-719-404-46	DIODE	MA110				
D417	8-719-404-46	DIODE	MA110				
D418	8-719-404-46	DIODE	MA110				
D419	8-719-404-46	DIODE	MA110				
D420	8-719-404-46	DIODE	MA110				
D421	8-719-404-46	DIODE	MA110				
D422	8-719-404-46	DIODE	MA110				
D423	8-719-404-46	DIODE	MA110				
D424	8-719-404-46	DIODE	MA110				
D425	8-719-404-46	DIODE	MA110				
D426	8-719-404-46	DIODE	MA110				
D427	8-719-404-46	DIODE	MA110				
D428	8-719-404-46	DIODE	MA110				
D429	8-719-404-46	DIODE	MA110				
D430	8-719-404-46	DIODE	MA110				
D431	8-719-404-46	DIODE	MA110				
<IC>							
IC401	8-759-287-89	IC	MM1113XFF				
IC402	8-759-287-89	IC	MM1113XFF				
IC403	8-759-420-04	IC	AN5265				
<COIL>							
L401	1-410-682-31	INDUCTOR			470UH		
L402	1-410-682-31	INDUCTOR			470UH		
<TRANSISTOR>							
Q401	8-729-120-28	TRANSISTOR	2SC1623-L5L6				
Q402	8-729-120-28	TRANSISTOR	2SC1623-L5L6				
Q403	8-729-216-22	TRANSISTOR	2SA1162-G				
Q404	8-729-120-28	TRANSISTOR	2SC1623-L5L6				
Q405	8-729-120-28	TRANSISTOR	2SC1623-L5L6				
Q406	8-729-120-28	TRANSISTOR	2SC1623-L5L6				
Q407	8-729-120-28	TRANSISTOR	2SC1623-L5L6				
Q408	8-729-120-28	TRANSISTOR	2SC1623-L5L6				
Q409	8-729-120-28	TRANSISTOR	2SC1623-L5L6				
Q410	8-729-120-28	TRANSISTOR	2SC1623-L5L6				
Q411	8-729-216-22	TRANSISTOR	2SA1162-G				
Q412	8-729-216-22	TRANSISTOR	2SA1162-G				
Q413	8-729-216-22	TRANSISTOR	2SA1162-G				
Q414	8-729-216-22	TRANSISTOR	2SA1162-G				
Q416	8-729-420-81	TRANSISTOR	2SD874A-R				
Q417	8-729-901-06	TRANSISTOR	DTA144EK				
Q418	8-729-901-06	TRANSISTOR	DTA144EK				
Q419	8-729-901-06	TRANSISTOR	DTA144EK				
Q420	8-729-901-01	TRANSISTOR	DTC144EK				
Q421	8-729-901-06	TRANSISTOR	DTA144EK				
Q422	8-729-901-01	TRANSISTOR	DTC144EK				



REF. NO.	PART NO.	DESCRIPTION	REMARK	REF. NO.	PART NO.	DESCRIPTION	REMARK
Q423	8-729-901-06	TRANSISTOR DTA144EK		R459	1-216-689-11	METAL GLAZE 39K 5%	1/10W
Q424	8-729-901-06	TRANSISTOR DTA144EK		R460	1-216-089-91	METAL GLAZE 47K 5%	1/10W
Q426	8-729-120-28	TRANSISTOR 2SC1623-L5L6		R461	1-216-097-00	METAL GLAZE 100K 5%	1/10W
<RESISTOR>				R462	1-216-115-00	METAL GLAZE 560K 5%	1/10W
R401	1-214-702-00	METAL 75 1%	1/4W	R463	1-216-105-00	METAL GLAZE 220K 5%	1/10W
R402	1-216-049-00	METAL GLAZE 1K 5%	1/10W	R464	1-216-077-00	METAL GLAZE 15K 5%	1/10W
R403	1-216-093-00	METAL GLAZE 68K 5%	1/10W	R465	1-216-025-00	METAL GLAZE 100 5%	1/10W
R404	1-216-091-00	METAL GLAZE 56K 5%	1/10W	R466	1-216-097-00	METAL GLAZE 100K 5%	1/10W
R405	1-216-063-00	METAL GLAZE 3.9K 5%	1/10W	R467	1-216-115-00	METAL GLAZE 560K 5%	1/10W
R406	1-216-037-00	METAL GLAZE 330 5%	1/10W	R468	1-216-105-00	METAL GLAZE 220K 5%	1/10W
R407	1-216-689-11	METAL GLAZE 39K 5%	1/10W	R469	1-216-077-00	METAL GLAZE 15K 5%	1/10W
R408	1-216-085-00	METAL GLAZE 33K 5%	1/10W	R470	1-216-025-00	METAL GLAZE 100 5%	1/10W
R409	1-214-702-00	METAL 75 1%	1/4W	R471	1-216-097-00	METAL GLAZE 100K 5%	1/10W
R410	1-216-049-00	METAL GLAZE 1K 5%	1/10W	R472	1-216-115-00	METAL GLAZE 560K 5%	1/10W
R411	1-216-093-00	METAL GLAZE 68K 5%	1/10W	R473	1-216-105-00	METAL GLAZE 220K 5%	1/10W
R412	1-216-091-00	METAL GLAZE 56K 5%	1/10W	R474	1-216-077-00	METAL GLAZE 15K 5%	1/10W
R413	1-216-063-00	METAL GLAZE 3.9K 5%	1/10W	R475	1-216-025-00	METAL GLAZE 100 5%	1/10W
R414	1-216-037-00	METAL GLAZE 330 5%	1/10W	R477	1-216-081-00	METAL GLAZE 22K 5%	1/10W
R415	1-216-061-00	METAL GLAZE 3.3K 5%	1/10W	R479	1-216-085-00	METAL GLAZE 33K 5%	1/10W
R416	1-216-023-00	METAL GLAZE 82 5%	1/10W	R480	1-247-711-11	CARBON 680 5%	1/4W
R417	1-216-049-00	METAL GLAZE 1K 5%	1/10W	R481	1-247-720-11	CARBON 3.9K 5%	1/4W
R418	1-216-093-00	METAL GLAZE 68K 5%	1/10W	R482	1-249-455-11	CARBON 4.7 5%	1/4W
R419	1-216-091-00	METAL GLAZE 56K 5%	1/10W	R483	1-249-389-11	CARBON 4.7 5%	1/4W F
R420	1-216-063-00	METAL GLAZE 3.9K 5%	1/10W	R484	1-216-041-00	METAL GLAZE 470 5%	1/10W
R421	1-216-027-00	METAL GLAZE 120 5%	1/10W	R485	1-247-688-11	CARBON 10 5%	1/4W F
R422	1-214-702-00	METAL 75 1%	1/4W	R486	1-216-037-00	METAL GLAZE 330 5%	1/10W
R423	1-214-702-00	METAL 75 1%	1/4W	R487	1-249-468-11	CARBON 82K 5%	1/4W
R424	1-216-049-00	METAL GLAZE 1K 5%	1/10W	R488	1-249-468-11	CARBON 82K 5%	1/4W
R425	1-216-093-00	METAL GLAZE 68K 5%	1/10W	R489	1-249-468-11	CARBON 82K 5%	1/4W
R426	1-216-091-00	METAL GLAZE 56K 5%	1/10W	R490	1-216-057-00	METAL GLAZE 2.2K 5%	1/10W
R427	1-216-063-00	METAL GLAZE 3.9K 5%	1/10W	R491	1-216-089-91	METAL GLAZE 47K 5%	1/10W
R428	1-216-037-00	METAL GLAZE 330 5%	1/10W	R492	1-216-089-91	METAL GLAZE 47K 5%	1/10W
R429	1-214-702-00	METAL 75 1%	1/4W	R493	1-216-089-91	METAL GLAZE 47K 5%	1/10W
R430	1-216-049-00	METAL GLAZE 1K 5%	1/10W	R494	1-216-089-91	METAL GLAZE 47K 5%	1/10W
R431	1-216-093-00	METAL GLAZE 68K 5%	1/10W	R495	1-216-295-91	METAL GLAZE 0 5%	1/10W
R432	1-216-091-00	METAL GLAZE 56K 5%	1/10W	R496	1-216-057-00	METAL GLAZE 2.2K 5%	1/10W
R433	1-216-063-00	METAL GLAZE 3.9K 5%	1/10W	R497	1-216-089-91	METAL GLAZE 47K 5%	1/10W
R434	1-216-027-00	METAL GLAZE 120 5%	1/10W	R498	1-216-089-91	METAL GLAZE 47K 5%	1/10W
R435	1-214-702-00	METAL 75 1%	1/4W	R499	1-216-089-91	METAL GLAZE 47K 5%	1/10W
R436	1-216-049-00	METAL GLAZE 1K 5%	1/10W	R1401	1-216-097-00	METAL GLAZE 100K 5%	1/10W
R437	1-216-093-00	METAL GLAZE 68K 5%	1/10W	R1403	1-216-295-91	METAL GLAZE 0 5%	1/10W
R438	1-216-091-00	METAL GLAZE 56K 5%	1/10W	R1404	1-216-097-00	METAL GLAZE 100K 5%	1/10W
R439	1-216-063-00	METAL GLAZE 3.9K 5%	1/10W	R1410	1-216-049-00	METAL GLAZE 1K 5%	1/10W
R440	1-216-027-00	METAL GLAZE 120 5%	1/10W	R1411	1-216-089-91	METAL GLAZE 47K 5%	1/10W
R441	1-216-089-91	METAL GLAZE 47K 5%	1/10W	R1412	1-216-113-00	METAL GLAZE 470K 5%	1/10W
R442	1-216-049-00	METAL GLAZE 1K 5%	1/10W	<VARIABLE RESISTOR>			
R443	1-216-689-11	METAL GLAZE 39K 5%	1/10W	RV401	1-237-994-11	RES, VAR, CARBON 20K	
R444	1-214-702-00	METAL 75 1%	1/4W	<SWITCH>			
R445	1-216-049-00	METAL GLAZE 1K 5%	1/10W	S401	1-570-145-11	SWITCH, SLIDE	
R446	1-216-093-00	METAL GLAZE 68K 5%	1/10W	*****			
R447	1-216-091-00	METAL GLAZE 56K 5%	1/10W	*A-1331-183-A	CA BOARD, COMPLETE		
R448	1-216-063-00	METAL GLAZE 3.9K 5%	1/10W		*****		
R449	1-216-027-00	METAL GLAZE 120 5%	1/10W	1-251-244-11	SOCKET, PICTURE TUBE		
R450	1-214-702-00	METAL 75 1%	1/4W	<CAPACITOR>			
R451	1-216-049-00	METAL GLAZE 1K 5%	1/10W	C701	1-162-114-00	CERAMIC 0.0047MF 10% 2KV	
R452	1-216-091-00	METAL GLAZE 56K 5%	1/10W				
R453	1-216-093-00	METAL GLAZE 68K 5%	1/10W				
R454	1-216-063-00	METAL GLAZE 3.9K 5%	1/10W				
R455	1-216-037-00	METAL GLAZE 330 5%	1/10W				
R456	1-216-085-00	METAL GLAZE 33K 5%	1/10W				
R457	1-216-085-00	METAL GLAZE 33K 5%	1/10W				
R458	1-247-707-11	CARBON 390 5%	1/4W				

CA D

REF. NO.	PART NO.	DESCRIPTION	REMARK	REF. NO.	PART NO.	DESCRIPTION	REMARK
C710	1-161-830-00	CERAMIC 0.0047MF 99%	500V	C530	1-163-097-00	CERAMIC CHIP 15PF	5%
				C531	1-131-370-00	TANTALUM 6.8MF	10%
		<CONNECTOR>		C532	1-124-557-11	ELECT 1000MF	20%
CN701	*1-564-509-11	PLUG, CONNECTOR 6P		C533	1-124-927-11	ELECT 4.7MF	20%
CN702	1-508-784-00	PIN, CONNECTOR (5MM PITCH) 1P		C534	1-124-768-11	ELECT 4.7MF	20%
CN703	*1-564-508-11	PLUG, CONNECTOR 5P		C535	1-136-161-00	FILM 0.047MF	5%
				C536	1-124-927-11	ELECT 4.7MF	20%
		<COIL>		C537	1-124-484-11	ELECT 220MF	20%
L701	1-410-668-11	INDUCTOR 27UH		C538	1-124-910-11	ELECT 47MF	20%
		<RESISTOR>		C539	1-136-113-00	FILM 2MF	5%
R701	1-202-822-00	SOLID 2.2K 20%	1/2W	C540	1-163-017-00	CERAMIC CHIP 0.0047MF	10%
R702	1-202-822-00	SOLID 2.2K 20%	1/2W	C541	1-163-035-00	CERAMIC CHIP 0.047MF	50V
R703	1-202-822-00	SOLID 2.2K 20%	1/2W				
R704	1-202-838-00	SOLID 100K 20%	1/2W	C542	1-126-103-11	ELECT 470MF	20%
R706	1-202-842-11	SOLID 220K 20%	1/2W	C545	1-126-101-11	ELECT 100MF	20%
		<VARIABLE RESISTOR>		C546	1-124-907-11	ELECT 10MF	20%
RV701	1-230-164-00	RES. ADJ. METAL GLAZE 55M		C547	1-124-907-11	ELECT 10MF	20%
	*4-376-132-11	COVER (REAR LID), CV VOL; RV701		C548	1-124-907-11	ELECT 10MF	20%
	*4-376-133-11	COVER (MAIN), CV VOL; RV701					

	*A-1346-251-A	D BOARD, COMPLETE		C549	1-124-907-11	ELECT 10MF	20%
		*****		C550	1-124-907-11	ELECT 10MF	20%
		<CAPACITOR>		C551	1-124-927-11	ELECT 4.7MF	20%
C501	1-124-477-11	ELECT 47MF	20%	C552	1-101-004-00	CERAMIC 0.01MF	50V
C502	1-124-907-11	ELECT 10MF	20%	C553	1-126-103-11	ELECT 470MF	20%
C503	1-126-103-11	ELECT 470MF	20%	C563	1-106-383-00	MYLAR 0.047MF	10%
C504	1-124-902-00	ELECT 0.47MF	20%	C564	1-163-009-11	CERAMIC CHIP 0.001MF	10%
C505	1-106-381-12	MYLAR 0.039MF	10%	C567	1-124-907-11	ELECT 10MF	20%
				C568	1-130-736-11	FILM 0.01MF	5%
C506	1-124-903-11	ELECT 1MF	20%	C569	1-130-471-00	FILM 0.001MF	5%
C507	1-106-367-00	MYLAR 0.01MF	10%				
C508	1-124-903-11	ELECT 1MF	20%	C570	1-163-117-00	CERAMIC CHIP 100PF	5%
C509	1-136-173-00	FILM 0.47MF	5%	C571	1-124-913-11	ELECT 470MF	20%
C510	1-136-161-00	FILM 0.047MF	5%	C572	1-101-004-00	CERAMIC 0.01MF	50V
				C574	1-106-351-00	MYLAR 0.0022MF	10%
C511	1-124-903-11	ELECT 1MF	20%	C575	1-106-351-00	MYLAR 0.0022MF	10%
C512	1-106-375-12	MYLAR 0.022MF	10%				
C513	1-106-375-12	MYLAR 0.022MF	10%	C578	1-163-031-11	CERAMIC CHIP 0.01MF	50V
C514	1-106-371-00	MYLAR 0.015MF	10%	C831	1-124-907-11	ELECT 10MF	20%
C515	1-124-925-11	ELECT 2.2MF	20%	C832	1-124-907-11	ELECT 10MF	20%
				C833	1-163-009-11	CERAMIC CHIP 0.001MF	10%
C516	1-124-925-11	ELECT 2.2MF	20%	C834	1-163-121-00	CERAMIC CHIP 150PF	5%
C517	1-130-480-00	FILM 0.0056MF	5%				
C518	1-163-245-11	CERAMIC CHIP 56PF	5%	C835	1-163-209-00	CERAMIC CHIP 0.0015MF	5%
C519	1-124-927-11	ELECT 4.7MF	20%	C836	1-124-907-11	ELECT 10MF	20%
C520	1-163-129-00	CERAMIC CHIP 330PF	5%	C837	1-163-209-00	CERAMIC CHIP 0.0015MF	5%
				C838	1-136-163-00	FILM 0.068MF	5%
C521	1-124-907-11	ELECT 10MF	20%	C839	1-106-351-00	MYLAR 0.0022MF	10%
C523	1-106-363-00	MYLAR 0.0068MF	10%				
C524	1-102-116-00	CERAMIC 680PF	10%	C840	1-163-209-00	CERAMIC CHIP 0.0015MF	5%
C525	1-102-820-00	CERAMIC 330PF	5%	C841	1-163-209-00	CERAMIC CHIP 0.0015MF	5%
C526	1-102-074-00	CERAMIC 0.001MF	10%	C843	1-124-902-00	ELECT 0.47MF	20%
				C844	1-124-902-00	ELECT 0.47MF	20%
C527	1-124-122-11	ELECT 100MF	20%	C845	1-124-477-11	ELECT 47MF	20%
C528	1-102-125-00	CERAMIC 0.0047MF	10%				
C529	1-124-910-11	ELECT 47MF	20%	C846	1-124-907-11	ELECT 10MF	20%
				C847	1-124-916-11	ELECT 22MF	20%
				C848	1-131-351-00	TANTALUM 4.7MF	10%
				C849	1-164-182-11	CERAMIC CHIP 0.0033MF	10%
				C1601	1-124-907-11	ELECT 10MF	20%
				C1602	1-164-161-11	CERAMIC CHIP 0.0022MF	10%
				C1603	1-104-348-11	ELECT 15MF	20%
				C1604	1-128-500-51	ELECT 1000MF	20%
				C1605	1-124-922-11	ELECT 1000MF	20%
				C1606	1-163-009-11	CERAMIC CHIP 0.001MF	10%
				C1607	1-124-907-11	ELECT 10MF	20%
				C1608	1-124-916-11	ELECT 22MF	20%
				C1609	1-163-009-11	CERAMIC CHIP 0.001MF	10%
				C1610	1-124-927-11	ELECT 4.7MF	20%
				C1611	1-124-482-11	ELECT 33MF	20%
				C1612	1-136-257-00	FILM 0.0039MF	5%

D

REF.NO.	PART NO.	DESCRIPTION	REMARK	REF.NO.	PART NO.	DESCRIPTION	REMARK
C1613	1-163-009-11	CERAMIC CHIP 0.001MF	10% 50V	F1601	1-532-777-21	FUSE, MICRO (SECONDARY) (1.25A/125V)	
C1614	1-164-232-11	CERAMIC CHIP 0.01MF	10% 50V	F1602	1-533-189-11	HOLDER, FUSE	
C1615	1-124-465-00	ELECT 0.47MF	20% 50V			<IC>	
C1620	1-163-133-00	CERAMIC CHIP 470PF	5% 50V				
C1621	1-163-117-00	CERAMIC CHIP 100PF	5% 50V				
C1641	1-163-035-00	CERAMIC CHIP 0.047MF	50V	IC501	8-759-909-70	IC CX23025	
<CONNECTOR>				IC502	8-759-100-60	IC UPC1377C	
CN501	*1-564-506-11	PLUG, CONNECTOR 3P		IC503	8-759-801-98	IC LA7830	
CN502	*1-564-011-11	PIN, CONNECTOR 12P			4-382-854-01	SCREW (M3X8), P, SW (+); IC503	
CN504	*1-564-508-11	PLUG, CONNECTOR 5P		IC504	8-759-231-58	IC TA7812S	
CN505	*1-564-509-11	PLUG, CONNECTOR 6P			4-382-854-01	SCREW (M3X8), P, SW (+); IC504	
CN507	1-564-511-11	PLUG, CONNECTOR 8P		IC505	8-759-009-51	IC MC14538BF	
CN508	*1-564-104-00	PIN, CONNECTOR (B3P-VH) 3P		IC506	8-759-209-54	IC TC4S01F	
CN509	*1-564-506-11	PLUG, CONNECTOR 3P		IC507	8-759-209-69	IC TC4S11F	
				IC831	8-759-509-29	IC XRU4011BF	
<DIODE>				IC832	8-759-509-37	IC XRU4070BF	
D501	8-719-404-46	DIODE MA110		IC833	8-759-009-51	IC MC14538BF	
D502	8-719-404-46	DIODE MA110		IC1601	8-759-509-91	IC XRA10393F	
D503	8-719-404-46	DIODE MA110		<COIL>			
D504	8-719-404-46	DIODE MA110		L501	1-410-093-11	INDUCTOR 33MMH	
D506	8-719-908-03	DIODE GPO8D		L502	1-410-665-31	INDUCTOR 15UH	
D507	8-719-404-46	DIODE MA110		L503	1-424-625-11	COIL, CHOKE (PMC) 381.4UH	
D508	8-719-404-46	DIODE MA110		L506	1-412-530-31	INDUCTOR 27UH	
D511	8-719-404-46	DIODE MA110		L1601	1-459-155-00	COIL (WITH CORE) 45UH	
D512	8-719-404-46	DIODE MA110		L1602	1-402-785-11	COIL, CHOKE 600UH	
D514	8-719-404-46	DIODE MA110		L1603	1-410-397-21	FERRITE BEAD INDUCTOR 1.1UH	
D520	8-719-800-76	DIODE ISS226		<TRANSISTOR>			
D521	8-719-800-76	DIODE ISS226		Q501	8-729-901-01	TRANSISTOR DTC144EK	
D831	8-719-404-46	DIODE MA110		Q502	8-729-901-01	TRANSISTOR DTC144EK	
D832	8-719-404-46	DIODE MA110		Q503	8-729-901-06	TRANSISTOR DTA144EK	
D833	8-719-404-46	DIODE MA110		Q504	8-729-901-01	TRANSISTOR DTC144EK	
D834	8-719-404-46	DIODE MA110		Q505	8-729-120-28	TRANSISTOR 2SC1623-L5L6	
D835	8-719-109-89	DIODE RD5.6ESB2		Q508	8-729-120-28	TRANSISTOR 2SC1623-L5L6	
D836	8-719-977-69	DIODE DTZ24B		Q509	8-729-120-28	TRANSISTOR 2SC1623-L5L6	
D848	8-719-800-76	DIODE ISS226		Q512	8-729-120-28	TRANSISTOR 2SC1623-L5L6	
D1601	8-719-105-99	DIODE RD6.2M-B1		Q513	8-729-216-22	TRANSISTOR 2SA1162-G	
D1603	8-719-977-61	DIODE DTZ20B		Q514	8-729-216-22	TRANSISTOR 2SA1162-G	
D1606	8-719-981-00	DIODE ERC81-004		Q515	8-729-313-42	TRANSISTOR 2SD1134-C	
D1607	8-719-981-00	DIODE ERC81-004			4-382-854-01	SCREW (M3X8), P, SW (+); Q515	
D1608	8-719-977-02	DIODE DTZ5.6A		Q518	8-729-120-28	TRANSISTOR 2SC1623-L5L6	
D1609	8-719-977-49	DIODE DTZ15B		Q519	8-729-120-28	TRANSISTOR 2SC1623-L5L6	
D1610	8-719-404-46	DIODE MA110		Q532	8-729-120-28	TRANSISTOR 2SC1623-L5L6	
D1611	8-729-101-31	TRANSISTOR N13T1		Q569	8-729-907-26	TRANSISTOR IMX1	
D1612	8-719-404-46	DIODE MA110		Q570	8-729-901-00	TRANSISTOR DTC124EK	
D1615	8-719-404-46	DIODE MA110		Q571	8-729-901-00	TRANSISTOR DTC124EK	
D1617	8-719-977-49	DIODE DTZ15B		Q576	8-729-901-01	TRANSISTOR DTC144EK	
D1618	8-719-977-49	DIODE DTZ15B		Q579	8-729-920-48	TRANSISTOR IMH2	
D1620	8-719-801-78	DIODE ISS184		Q599	8-729-920-48	TRANSISTOR IMH2	
D1621	8-719-510-12	DIODE D10SC4M		Q833	8-729-216-22	TRANSISTOR 2SA1162-G	
D1622	4-382-854-11	SCREW (M3X10), P, SW (+); Q1621		Q834	8-729-120-28	TRANSISTOR 2SC1623-L5L6	
D1622	8-719-801-78	DIODE ISS184		Q835	8-729-120-28	TRANSISTOR 2SC1623-L5L6	
D1623	8-719-801-78	DIODE ISS184		Q836	8-729-255-12	TRANSISTOR 2SC2551-0	
D1626	8-719-404-46	DIODE MA110		Q1601	8-729-120-28	TRANSISTOR 2SC1623-L5L6	
D1627	8-719-404-46	DIODE MA110		Q1602	8-729-120-28	TRANSISTOR 2SC1623-L5L6	
D1628	8-719-404-46	DIODE MA110		Q1603	8-729-120-28	TRANSISTOR 2SC1623-L5L6	
D1635	8-719-404-46	DIODE MA110		Q1604	8-729-216-22	TRANSISTOR 2SA1162-G	
D1699	8-719-404-46	DIODE MA110		Q1605	8-729-119-80	TRANSISTOR 2SC2688-LK	
<FUSE>				Q1606	8-729-133-42	TRANSISTOR 2SC2334-L	
					4-382-854-01	SCREW (M3X8), P, SW (+); Q1606	
				Q1607	8-729-120-28	TRANSISTOR 2SC1623-L5L6	

D

REF. NO.	PART NO.	DESCRIPTION	REMARK	REF. NO.	PART NO.	DESCRIPTION	REMARK
Q1608	8-729-120-28	TRANSISTOR 2SC1623-L5L6		R549	1-216-101-00	METAL GLAZE 150K 5%	1/10W
Q1609	8-729-120-28	TRANSISTOR 2SC1623-L5L6		R550	1-216-357-00	METAL OXIDE 4.7 5%	1W F
Q1610	8-729-120-28	TRANSISTOR 2SC1623-L5L6		R552	1-216-061-00	METAL GLAZE 3.3K 5%	1/10W
Q1611	8-729-120-28	TRANSISTOR 2SC1623-L5L6		R553	1-216-689-11	METAL GLAZE 39K 5%	1/10W
Q1612	8-729-120-28	TRANSISTOR 2SC1623-L5L6		R554	1-216-073-00	METAL GLAZE 10K 5%	1/10W
Q1613	8-729-120-28	TRANSISTOR 2SC1623-L5L6		R555	1-216-077-00	METAL GLAZE 15K 5%	1/10W
Q1614	8-729-120-28	TRANSISTOR 2SC1623-L5L6		R557	1-216-057-00	METAL GLAZE 2.2K 5%	1/10W
Q1615	8-729-216-22	TRANSISTOR 2SA1162-G		R558	1-216-049-00	METAL GLAZE 1K 5%	1/10W
Q1616	8-729-216-22	TRANSISTOR 2SA1162-G		R559	1-216-065-00	METAL GLAZE 4.7K 5%	1/10W
Q1617	8-729-216-22	TRANSISTOR 2SA1162-G		R560	1-216-037-00	METAL GLAZE 330 5%	1/10W
Q1618	8-729-216-22	TRANSISTOR 2SA1162-G		R561	1-216-081-00	METAL GLAZE 22K 5%	1/10W
<RESISTOR>				R562	1-216-053-00	METAL GLAZE 1.5K 5%	1/10W
JR510	1-216-295-91	METAL GLAZE 0	5% 1/10W	R563	1-216-061-00	METAL GLAZE 3.3K 5%	1/10W
JR517	1-216-295-91	METAL GLAZE 0	5% 1/10W	R564	1-249-415-11	CARBON 680 5%	1/4W F
R501	1-216-089-91	METAL GLAZE 47K	5% 1/10W	R565	1-216-059-00	METAL GLAZE 2.7K 5%	1/10W
R502	1-216-089-91	METAL GLAZE 47K	5% 1/10W	R566	1-216-025-00	METAL GLAZE 100 5%	1/10W
R503	1-249-437-11	CARBON 47K	5% 1/4W F	R567	1-216-095-00	METAL GLAZE 82K 5%	1/10W
R504	1-216-073-00	METAL GLAZE 10K	5% 1/10W	R568	1-216-063-00	METAL GLAZE 3.9K 5%	1/10W
R505	1-249-393-11	CARBON 10	5% 1/4W F	R569	1-216-063-00	METAL GLAZE 3.9K 5%	1/10W
R506	1-216-071-00	METAL GLAZE 8.2K	5% 1/10W	R570	1-216-093-00	METAL GLAZE 68K 5%	1/10W
R507	1-216-059-00	METAL GLAZE 2.7K	5% 1/10W	R571	1-216-089-91	METAL GLAZE 47K 5%	1/10W
R508	1-216-085-00	METAL GLAZE 33K	5% 1/10W	R572	1-216-095-00	METAL GLAZE 82K 5%	1/10W
R509	1-216-687-11	METAL CHIP 33K	0.50% 1/10W	R573	1-216-063-00	METAL GLAZE 3.9K 5%	1/10W
R510	1-216-683-11	METAL CHIP 22K	0.50% 1/10W	R574	1-216-063-00	METAL GLAZE 3.9K 5%	1/10W
R511	1-216-675-11	METAL CHIP 10K	0.50% 1/10W	R575	1-216-105-00	METAL GLAZE 220K 5%	1/10W
R512	1-218-761-11	METAL CHIP 240K	0.50% 1/10W	R576	1-216-109-00	METAL GLAZE 330K 5%	1/10W
R513	1-216-065-00	METAL GLAZE 4.7K	5% 1/10W	R577	1-216-105-00	METAL GLAZE 220K 5%	1/10W
R514	1-218-754-11	METAL CHIP 120K	0.50% 1/10W	R578	1-249-457-11	CARBON 6.8 5%	1/4W F
R515	1-216-081-00	METAL GLAZE 22K	5% 1/10W	R579	1-249-457-11	CARBON 6.8 5%	1/4W F
R516	1-216-073-00	METAL GLAZE 10K	5% 1/10W	R589	1-216-101-00	METAL GLAZE 150K 5%	1/10W
R517	1-218-762-11	METAL CHIP 270K	0.50% 1/10W	R591	1-216-063-00	METAL GLAZE 3.9K 5%	1/10W
R518	1-249-422-11	CARBON 2.7K	5% 1/4W F	R592	1-216-033-00	METAL GLAZE 220 5%	1/10W
R519	1-216-085-00	METAL GLAZE 33K	5% 1/10W	R593	1-216-101-00	METAL GLAZE 150K 5%	1/10W
R520	1-216-677-11	METAL CHIP 12K	0.50% 1/10W	R594	1-216-065-00	METAL GLAZE 4.7K 5%	1/10W
R521	1-216-067-00	METAL GLAZE 5.6K	5% 1/10W	R831	1-216-049-00	METAL GLAZE 1K 5%	1/10W
R522	1-216-107-00	METAL GLAZE 270K	5% 1/10W	R832	1-216-075-00	METAL GLAZE 12K 5%	1/10W
R523	1-216-081-00	METAL GLAZE 22K	5% 1/10W	R833	1-216-065-00	METAL GLAZE 4.7K 5%	1/10W
R524	1-216-049-00	METAL GLAZE 1K	5% 1/10W	R834	1-216-059-00	METAL GLAZE 2.7K 5%	1/10W
R525	1-216-434-11	METAL OXIDE 1.8K	5% 1W F	R835	1-216-081-00	METAL GLAZE 22K 5%	1/10W
R526	1-216-079-00	METAL GLAZE 18K	5% 1/10W	R836	1-216-049-00	METAL GLAZE 1K 5%	1/10W
R527	1-249-437-11	CARBON 47K	5% 1/4W F	R837	1-216-075-00	METAL GLAZE 12K 5%	1/10W
R528	1-216-073-00	METAL GLAZE 10K	5% 1/10W	R838	1-216-049-00	METAL GLAZE 1K 5%	1/10W
R529	1-216-073-00	METAL GLAZE 10K	5% 1/10W	R839	1-216-061-00	METAL GLAZE 3.3K 5%	1/10W
R530	1-216-089-91	METAL GLAZE 47K	5% 1/10W	R840	1-216-097-00	METAL GLAZE 100K 5%	1/10W
R531	1-216-089-91	METAL GLAZE 47K	5% 1/10W	R841	1-216-093-00	METAL GLAZE 68K 5%	1/10W
R532	1-216-097-00	METAL GLAZE 100K	5% 1/10W	R842	1-216-093-00	METAL GLAZE 68K 5%	1/10W
R533	1-216-089-91	METAL GLAZE 47K	5% 1/10W	R843	1-216-065-00	METAL GLAZE 4.7K 5%	1/10W
R534	1-216-097-00	METAL GLAZE 100K	5% 1/10W	R844	1-216-077-00	METAL GLAZE 15K 5%	1/10W
R535	1-216-053-00	METAL GLAZE 1.5K	5% 1/10W	R847	1-216-049-00	METAL GLAZE 1K 5%	1/10W
R536	1-212-881-11	FUSIBLE 100	5% 1/4W F	R850	1-216-085-00	METAL GLAZE 33K 5%	1/10W
R537	1-215-867-00	METAL OXIDE 470	5% 1W F	R851	1-208-800-11	METAL CHIP 5.6K 0.50%	1/10W
R538	1-216-095-00	METAL GLAZE 82K	5% 1/10W	R852	1-216-675-11	METAL CHIP 10K 0.50%	1/10W
R539	1-216-095-00	METAL GLAZE 82K	5% 1/10W	R853	1-216-105-00	METAL GLAZE 220K 5%	1/10W
R540	1-216-101-00	METAL GLAZE 150K	5% 1/10W	R854	1-218-754-11	METAL CHIP 120K 0.50%	1/10W
R541	1-216-063-00	METAL GLAZE 3.9K	5% 1/10W	R855	1-216-697-91	METAL CHIP 82K 0.50%	1/10W
R542	1-216-075-00	METAL GLAZE 12K	5% 1/10W	R856	1-216-699-11	METAL CHIP 100K 0.50%	1/10W
R543	1-216-065-00	METAL GLAZE 4.7K	5% 1/10W	R857	1-216-686-11	METAL CHIP 30K 0.50%	1/10W
R544	1-216-101-00	METAL GLAZE 150K	5% 1/10W	R858	1-216-061-00	METAL GLAZE 3.3K 5%	1/10W
R545	1-216-033-00	METAL GLAZE 220	5% 1/10W	R859	1-216-436-00	METAL OXIDE 3.9K 5%	1W F
R546	1-216-091-00	METAL GLAZE 56K	5% 1/10W	R860	1-216-675-11	METAL CHIP 10K 0.50%	1/10W
R547	1-216-121-00	METAL GLAZE 1M	5% 1/10W	R861	1-216-671-11	METAL CHIP 6.8K 0.50%	1/10W
R548	1-216-107-00	METAL GLAZE 270K	5% 1/10W	R862	1-216-675-11	METAL CHIP 10K 0.50%	1/10W
				R863	1-249-435-11	CARBON 33K 5%	1/4W F

HA X S

REF. NO.	PART NO.	DESCRIPTION	REMARK	REF. NO.	PART NO.	DESCRIPTION	REMARK
R002	1-216-295-91	METAL GLAZE 0 5% 1/10W		C1116	1-163-114-00	CERAMIC CHIP 75PF 5% 50V	
R003	1-216-295-91	METAL GLAZE 0 5% 1/10W		C1117	1-124-589-11	ELECT 47MF 20% 16V	
R004	1-216-081-00	METAL GLAZE 22K 5% 1/10W		C1118	1-164-004-11	CERAMIC CHIP 0.1MF 10% 25V	
				C1119	1-163-020-00	CERAMIC CHIP 0.0082MF 10% 50V	
				C1120	1-163-097-00	CERAMIC CHIP 15PF 5% 50V	
		<VARIABLE RESISTOR>		C1121	1-163-097-00	CERAMIC CHIP 15PF 5% 50V	
RV001	1-223-504-21	RES, VAR, CARBON 20K		C1122	1-163-222-11	CERAMIC CHIP 5PF 0.25PF 50V	
RV002	1-223-504-21	RES, VAR, CARBON 20K		C1123	1-163-097-00	CERAMIC CHIP 15PF 5% 50V	
RV003	1-223-735-11	RES, VAR, CARBON 20K		C1130	1-163-097-00	CERAMIC CHIP 15PF 5% 50V	
RV004	1-223-735-11	RES, VAR, CARBON 20K		C1131	1-163-097-00	CERAMIC CHIP 15PF 5% 50V	
RV005	1-223-735-11	RES, VAR, CARBON 20K				<CONNECTOR>	
RV006	1-223-735-11	RES, VAR, CARBON 20K		CN1101*	1-565-488-11	CONNECTOR, BOARD TO BOARD 12P	
RV007	1-226-773-11	RES, ADJ, METAL GLAZE 22K				<DIODE>	
RV008	1-226-773-11	RES, ADJ, METAL GLAZE 22K		D1101	8-719-404-46	DIODE MA110	
RV009	1-226-773-11	RES, ADJ, METAL GLAZE 22K		D1102	8-719-404-46	DIODE MA110	
RV010	1-226-773-11	RES, ADJ, METAL GLAZE 22K				<IC>	
RV011	1-226-773-11	RES, ADJ, METAL GLAZE 22K		IC1101	8-752-056-67	IC CXA1214P	
RV012	1-226-773-11	RES, ADJ, METAL GLAZE 22K				<COIL>	
		<SWITCH>		L1101	1-408-411-00	INDUCTOR 15UH	
S001	1-554-419-00	SWITCH, PUSH (1 KEY)		L1102	1-404-496-00	COIL	
S002	1-554-419-00	SWITCH, PUSH (1 KEY)		L1103	1-404-496-00	COIL	
S003	1-554-419-00	SWITCH, PUSH (1 KEY)		L1104	1-408-411-00	INDUCTOR 15UH	
S004	1-554-419-00	SWITCH, PUSH (1 KEY)		L1110	1-412-008-31	INDUCTOR CHIP 15UH	
S005	1-554-419-00	SWITCH, PUSH (1 KEY)		L1111	1-412-008-31	INDUCTOR CHIP 15UH	
S006	1-554-419-00	SWITCH, PUSH (1 KEY)				<TRANSISTOR>	
		*****		Q1101	8-729-216-22	TRANSISTOR 2SA1162-G	
		*A-1390-276-A X BOARD, COMPLETE		Q1102	8-729-120-28	TRANSISTOR 2SC1623-L5L6	
		*****		Q1103	8-729-216-22	TRANSISTOR 2SA1162-G	
		<CONNECTOR>		Q1104	8-729-216-22	TRANSISTOR 2SA1162-G	
CN21	*1-564-518-11	PLUG, CONNECTOR 3P		Q1105	8-729-901-01	TRANSISTOR DTC144EK	
		<DIODE>		Q1106	8-729-901-01	TRANSISTOR DTC144EK	
D21	8-719-023-78	DIODE SEL3810DLC05		Q1107	8-729-109-44	TRANSISTOR 2SK94-X4	
D22	8-719-023-78	DIODE SEL3810DLC05		Q1108	8-729-120-28	TRANSISTOR 2SC1623-L5L6	
D23	8-719-023-78	DIODE SEL3810DLC05				<RESISTOR>	
		*****		R1101	1-216-053-00	METAL GLAZE 1.5K 5% 1/10W	
		*A-1394-368-A S BOARD, COMPLETE		R1102	1-216-067-00	METAL GLAZE 5.6K 5% 1/10W	
		*****		R1103	1-216-059-00	METAL GLAZE 2.7K 5% 1/10W	
		<CAPACITOR>		R1104	1-216-073-00	METAL GLAZE 10K 5% 1/10W	
C1101	1-163-119-00	CERAMIC CHIP 120PF 5% 50V		R1105	1-216-031-00	METAL GLAZE 180 5% 1/10W	
C1102	1-164-004-11	CERAMIC CHIP 0.1MF 10% 25V		R1106	1-216-059-00	METAL GLAZE 2.7K 5% 1/10W	
C1103	1-124-589-11	ELECT 47MF 20% 16V		R1107	1-216-071-00	METAL GLAZE 8.2K 5% 1/10W	
C1104	1-163-031-11	CERAMIC CHIP 0.01MF 50V		R1108	1-216-039-00	METAL GLAZE 390 5% 1/10W	
C1105	1-163-114-00	CERAMIC CHIP 75PF 5% 50V		R1109	1-216-063-00	METAL GLAZE 3.9K 5% 1/10W	
C1106	1-163-101-00	CERAMIC CHIP 22PF 5% 50V		R1110	1-216-069-00	METAL GLAZE 6.8K 5% 1/10W	
C1107	1-164-004-11	CERAMIC CHIP 0.1MF 10% 25V		R1111	1-216-065-00	METAL GLAZE 4.7K 5% 1/10W	
C1108	1-163-119-00	CERAMIC CHIP 120PF 5% 50V		R1112	1-216-059-00	METAL GLAZE 2.7K 5% 1/10W	
C1109	1-163-031-11	CERAMIC CHIP 0.01MF 50V		R1113	1-216-069-00	METAL GLAZE 6.8K 5% 1/10W	
C1110	1-163-117-00	CERAMIC CHIP 100PF 5% 50V		R1114	1-216-055-00	METAL GLAZE 1.8K 5% 1/10W	
C1111	1-163-018-00	CERAMIC CHIP 0.0056MF 10% 50V		R1115	1-216-061-00	METAL GLAZE 3.3K 5% 1/10W	
C1112	1-126-160-11	ELECT 1MF 20% 50V		R1116	1-216-069-00	METAL GLAZE 6.8K 5% 1/10W	
C1113	1-163-119-00	CERAMIC CHIP 120PF 5% 50V		R1117	1-216-061-00	METAL GLAZE 3.3K 5% 1/10W	
C1114	1-163-103-00	CERAMIC CHIP 27PF 5% 50V		R1118	1-216-073-00	METAL GLAZE 10K 5% 1/10W	
C1115	1-164-004-11	CERAMIC CHIP 0.1MF 10% 25V					

The components identified by shading and mark Δ are critical for safety. Replace only with part number specified.

• The components identified by \square in this manual have been carefully factory-selected for each set in order to satisfy regulations regarding X-ray radiation. Should replacement be required, replace only with the value originally used.



REF. NO.	PART NO.	DESCRIPTION	REMARK	REF. NO.	PART NO.	DESCRIPTION	REMARK
R1119	1-216-049-00	METAL GLAZE 1K 5%	1/10W	D651 Δ	8-719-971-08	DIODE ESAC39M 06C	
R1120	1-216-097-00	METAL GLAZE 100K 5%	1/10W			<IC>	
R1121	1-216-121-00	METAL GLAZE 1M 5%	1/10W	IC601 Δ	1-809-086-12	HIC CH-1018	
R1122	1-216-039-00	METAL GLAZE 390 5%	1/10W	IC651 Δ	8-759-908-15	IC TL431CLP	
R1123	1-216-065-00	METAL GLAZE 4.7K 5%	1/10W	PH601 Δ	8-759-045-81	IC TLP732GR-LF2	
R1124	1-216-029-00	METAL GLAZE 150 5%	1/10W			<COIL>	
R1125	1-216-029-00	METAL GLAZE 150 5%	1/10W	L601 Δ	1-424-616-11	TRANSFORMER, LINE FILTER	
R1126	1-216-053-00	METAL GLAZE 1.5K 5%	1/10W	L602 Δ	1-424-574-11	L:F.T	
R1127	1-216-043-00	METAL GLAZE 560 5%	1/10W	L651 Δ	1-424-255-41	COIL, CHOKE (MOLDE) 10UH	
R1128	1-216-049-00	METAL GLAZE 1K 5%	1/10W	L652 Δ	1-424-615-11	COIL, CHOKE	
R1129	1-216-091-00	METAL GLAZE 56K 5%	1/10W			<TRANSISTOR>	
R1131	1-216-073-00	METAL GLAZE 10K 5%	1/10W	Q601 Δ	8-729-322-18	TRANSISTOR 2SK1402A	
R1132	1-216-073-00	METAL GLAZE 10K 5%	1/10W			<RESISTOR>	
R1133	1-216-073-00	METAL GLAZE 10K 5%	1/10W	R601 Δ	1-205-940-51	CEMENT 1.5 5%	5W F
R1134	1-216-091-00	METAL GLAZE 56K 5%	1/10W	R602 Δ	1-205-940-51	CEMENT 1.5 5%	5W F
		<VARIABLE RESISTOR>		R603 Δ	1-215-904-11	METAL OXIDE 100K 5%	2W F
RV1101	1-241-763-11	RES, ADJ, CARBON 4.7K		R604 Δ	1-215-904-11	METAL OXIDE 100K 5%	2W F
RV1102	1-241-628-11	RES, ADJ, CARBON 2.2K		R605 Δ	1-212-865-61	FUSIBLE 22 5%	1/4W F
		<TRANSFORMER>		R606 Δ	1-247-805-91	CARBON 82 5%	1/4W
T1101	1-404-584-11	COIL		R607 Δ	1-260-128-91	CARBON 270K 5%	1/2W
		*****		R608 Δ	1-260-128-91	CARBON 270K 5%	1/2W
		G BOARD (SOPS-1021(A))		R609 Δ	1-215-904-51	METAL OXIDE 100K 5%	2W F
		*****		R610 Δ	1-207-455-11	WIRE 0.22 10%	1/2W
		4-812-134-11 RIVET NYLON, 3.5 ϕ		R611 Δ	1-249-395-11	CARBON (SMALL) 15 5%	1/4W
		<CAPACITOR>		R612 Δ	1-247-795-91	CARBON 33 5%	1/4W
C602 Δ	1-136-889-11	METALIZED FILM 0.22MF 20%	250V	R613 Δ	1-215-904-51	METAL OXIDE 100K 5%	2W F
C603 Δ	1-161-741-00	CERAMIC 0.001MF B 10%	400V	R614 Δ	1-247-815-91	CARBON 220 5%	1/4W
C604 Δ	1-161-741-00	CERAMIC 0.001MF B 10%	400V	R620 Δ	1-218-265-11	METAL OXIDE 8.2M 5%	1W
C605 Δ	1-161-741-00	CERAMIC 0.001MF B 10%	400V	R651 Δ	1-215-886-51	METAL OXIDE 100 5%	2W F
C608 Δ	1-162-599-12	CERAMIC 0.0047MF 20%	400V	R652 Δ	1-215-886-51	METAL OXIDE 100 5%	2W F
C609 Δ	1-162-599-12	CERAMIC 0.0047MF 20%	400V	R653 Δ	1-260-107-91	CARBON 4.7K 5%	1/2W
C610 Δ	1-125-724-11	ELECT 180MF 20%	400V	R654 Δ	1-260-107-91	CARBON 4.7K 5%	1/2W
C611 Δ	1-136-206-21	METALIZED FILM 0.033MF 10%	630V	R655 Δ	1-247-867-91	CARBON 33K 5%	1/4W
C612 Δ	1-124-910-51	ELECT 47MF 20%	50V	R656 Δ	1-247-867-91	CARBON 33K 5%	1/4W
C613 Δ	1-137-190-91	METALIZED FILM 0.22MF 5%	50V	R657 Δ	1-247-837-91	CARBON 1.8K 5%	1/4W
C614 Δ	1-137-190-91	METALIZED FILM 0.22MF 5%	50V	R658 Δ	1-249-435-11	CARBON (SMALL) 33K 5%	1/4W
C615 Δ	1-130-471-91	PE TEREPHTHALATE 0.001MF 5%	50V			<VARIABLE RESISTOR>	
C616 Δ	1-130-479-00	FILM 0.0047MF 5%	50V	\square RV651 Δ	1-237-443-11	RES, ADJ, CARBON 1K	
C651 Δ	1-161-825-11	CERAMIC 220PF B 10%	500V			<TRANSFORMER>	
C652 Δ	1-128-486-51	ELECT 680MF 20%	50V	T601 Δ	1-450-760-11	TRANSFORMER, CONVERTER	
C653 Δ	1-128-485-51	ELECT 220MF 20%	50V			*****	
C654 Δ	1-130-483-91	PE TEREPHTHALATE 0.01MF 5%	50V			MISCELLANEOUS	
		<CONNECTOR>				*****	
CN610 Δ	1-560-436-11	HORIZONTAL PIN ASSY 3P		Δ 1-413-720-24		SWITCHING REGULATOR (SOPS-1021(A))	
CN651 Δ	1-564-518-11	PLUG, CONNECTOR 3P		Δ 1-426-043-12		COIL, DEGAUSSING	
		<DIODE>		Δ 1-451-319-22		DEFLECTION YOKE (Y9FXC)	
D201 Δ	8-719-971-08	DIODE ESAC39M 06C		1-452-126-11		MAGNET	
D601 Δ	8-719-510-27	DIODE D3SB60		1-544-252-11		SPEAKER	
D602 Δ	8-719-921-20	DIODE 1SS119TD		Δ 1-576-232-11		FUSE (H.B.C.) (5.0A/250V)	
D603 Δ	8-719-981-47	DIODE ERA38-06TP1		1-690-871-11		CABLE (MINI DIN) 8P	
D604 Δ	8-719-981-47	DIODE ERA38-06TP1					
D605 Δ	8-719-113-44	DIODE RD20ES-T1B3					

The components identified by shading and mark Δ are critical for safety. Replace only with part number specified.

REF.NO.	PART NO.	DESCRIPTION	REMARK
	1-941-866-12	CONNECTOR ASSY	
	1-941-913-02	CORE ASSY, FERRITE	
V901	Δ 8-737-154-05	PICTURE TUBE (09NDX) (PVM-9041QM)	
V901	Δ 8-737-651-05	PICTURE TUBE (09FX) (PVM-9044QM)	

ACCESSORIES AND PACKING MATERIALS

Δ 1-590-910-11	CORD SET, POWER (10A/250V)
1-690-871-11	CABLE (MINI DIN) 8P
2-990-241-02	HOLDER (A), PLUG
3-170-078-01	HOLDER (B), PLUG
*3-704-301-01	BAG (STANDARD), PROTECTION
3-754-506-24	MANUAL, INSTRUCTION
4-034-835-01	PLATE, TALLY
*4-034-955-01	CUSHION (UPPER) (ASSY)
*4-034-956-01	CUSHION (LOWER) (ASSY)
*4-046-435-01	INDIVIDUAL CARTON (PVM-9041QM)
*4-046-436-01	INDIVIDUAL CARTON (PVM-9044QM)